

RADIO'S GREATEST MAGAZINE

K

# RADIO-CRAFT

Incorporating

**RADIO &  
TELEVISION**

HUGO GERNSBACK, Editor

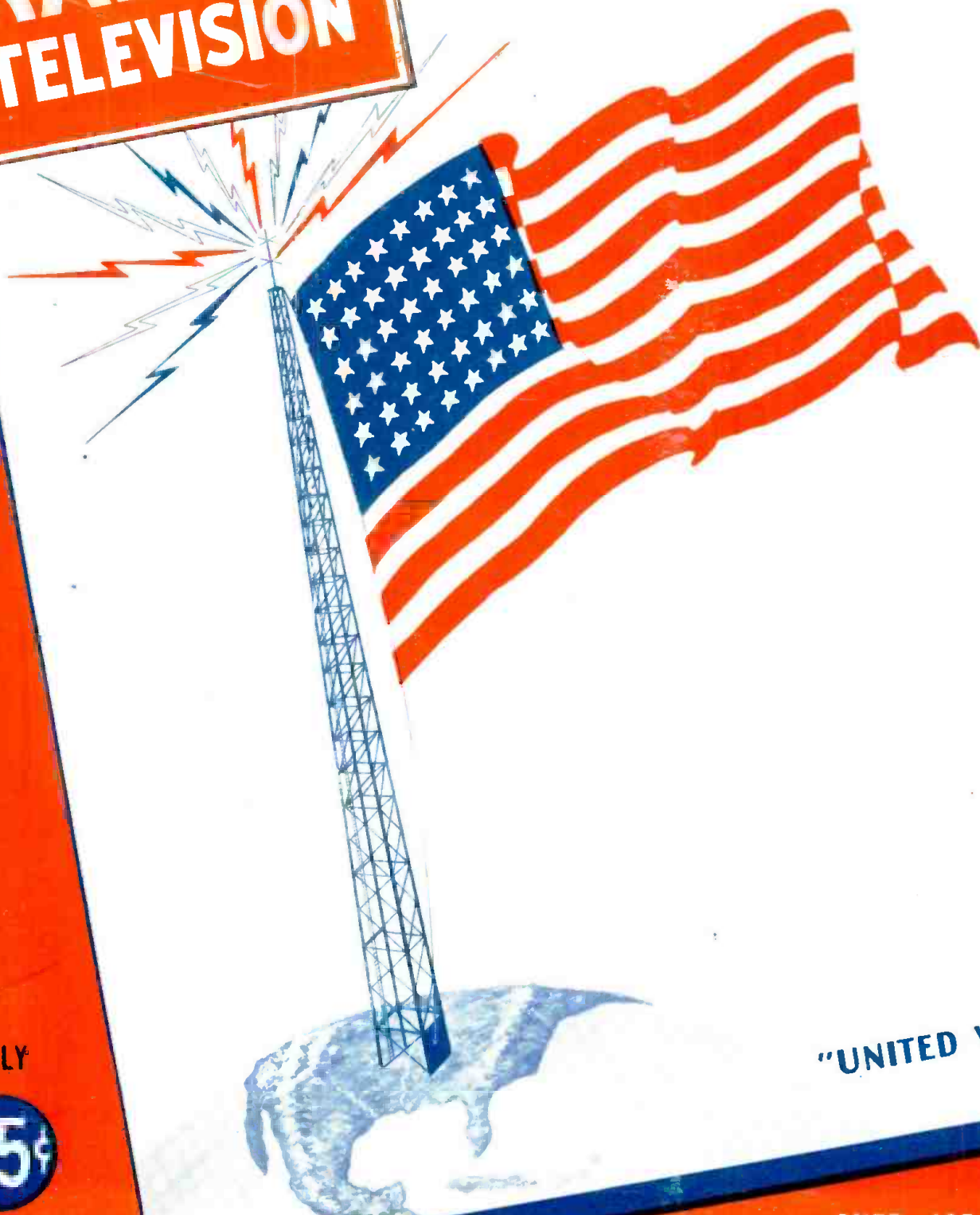

"UNITED WE STAND"

JULY

25¢

CANADA 30¢

1942

OVER 125 ILLUSTRATIONS

*the Commandos*  
could tell you about  
**hallicrafters**  
communications equipment

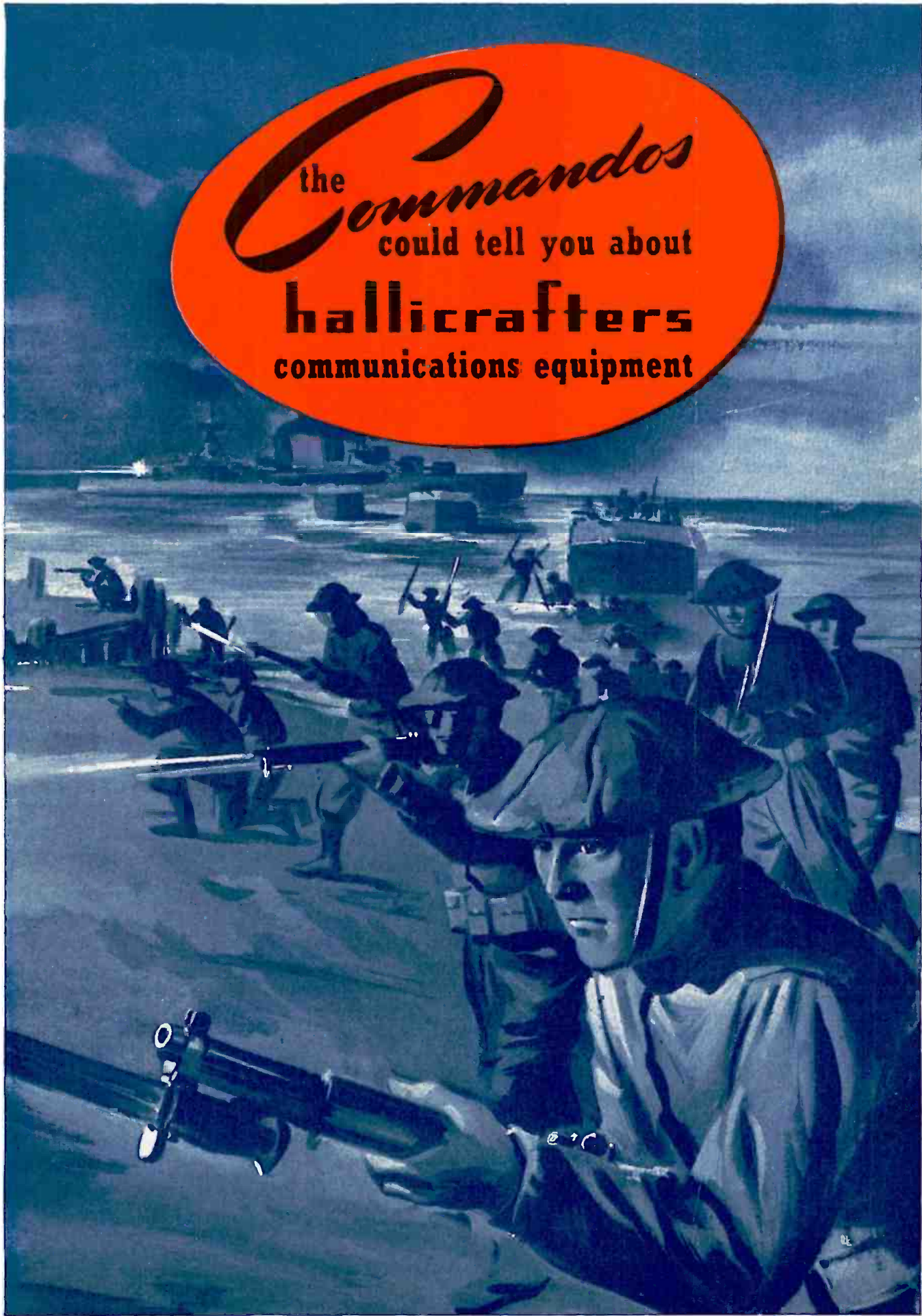

# A FREE LESSON SHOWED BILL HOW HE COULD MAKE GOOD PAY IN RADIO



I CAN'T FIND OUT WHAT'S WRONG-- GUESS I'LL MAKE A FOOL OF MYSELF WITH MARY



HELLO, BILL-- GOT A TOUGH ONE TO FIX? LET ME HELP YOU



HELLO JOE-- WHERE'VE YOU BEEN LATELY-- AND WHERE DID YOU LEARN ANYTHING ABOUT RADIO?

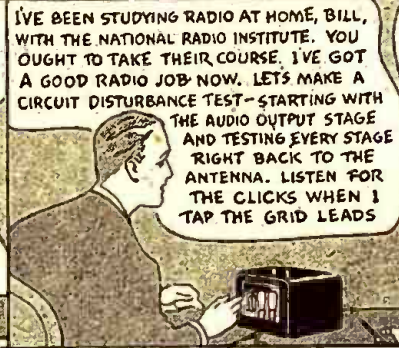

I'VE BEEN STUDYING RADIO AT HOME, BILL, WITH THE NATIONAL RADIO INSTITUTE. YOU OUGHT TO TAKE THEIR COURSE. I'VE GOT A GOOD RADIO JOB NOW. LET'S MAKE A CIRCUIT DISTURBANCE TEST-- STARTING WITH THE AUDIO OUTPUT STAGE AND TESTING EVERY STAGE RIGHT BACK TO THE ANTENNA. LISTEN FOR THE CLICKS WHEN I TAP THE GRID LEADS



SAY-- WHERE DID YOU LEARN THAT TEST? IT'S A GOOD ONE

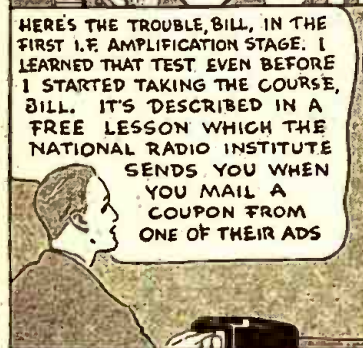

HERE'S THE TROUBLE, BILL, IN THE FIRST I.F. AMPLIFICATION STAGE. I LEARNED THAT TEST EVEN BEFORE I STARTED TAKING THE COURSE, BILL. IT'S DESCRIBED IN A FREE LESSON WHICH THE NATIONAL RADIO INSTITUTE SENDS YOU WHEN YOU MAIL A COUPON FROM ONE OF THEIR ADS



I'VE SEEN THEIR ADS BUT I NEVER THOUGHT I COULD LEARN RADIO AT HOME-- I'LL MAIL THEIR COUPON RIGHT AWAY



I'M CONVINCED NOW THAT THIS COURSE IS PRACTICAL AND COMPLETE. I'LL ENROLL NOW

AND THEN I CAN MAKE REAL MONEY FIXING RADIO SETS

OR INSTALL AND SERVICE LOUD SPEAKER SYSTEMS



OR GET A JOB IN A BROADCASTING STATION OR AVIATION RADIO OR POLICE RADIO



THE GOVERNMENT NEEDS CIVILIAN RADIO OPERATORS AND TECHNICIANS. IF I'M DRAFTED, KNOWING RADIO CAN WIN ME EXTRA RANK AND PAY. HUNDREDS OF N.R.I. TRAINED MEN HAVE GOOD RADIO JOBS

## I will send you a Lesson on Radio Servicing Tips FREE TO SHOW HOW PRACTICAL IT IS TO TRAIN AT HOME FOR GOOD JOBS IN RADIO



J. E. SMITH, President National Radio Institute Established 27 Years

He has directed the training of more men for the Radio Industry than anyone else.



YOU CERTAINLY KNOW RADIO SOUNDS AS GOOD AS THE DAY I BOUGHT IT.

THANKS! IT CERTAINLY IS EASY TO LEARN RADIO THE N.R.I. WAY. I STARTED ONLY A FEW MONTHS AGO, AND I'M ALREADY MAKING GOOD MONEY.

THIS SPARE TIME WORK IS GREAT FUN AND PRETTY SOON I'LL BE READY FOR A FULL TIME JOB

Every man who works on a Radio Receiver, either professionally or as a hobby, should have a copy of my Free Sample Lesson, "Radio Receiver Troubles--Their Cause and Remedy." I will send you your copy without obligation if you will mail the Coupon below. It will show you how practical my lessons are--give you a real idea of the vast amount of information my Course gives you.

More Now Make \$30, \$40, \$50 A Week Than Ever Before

The Radio repair business is booming now, because manufacture of new Radio sets has been discontinued and the 57,400,000 home and auto Radios require more repairs, tubes, parts as they get older. Many Radio Technicians have their own Radio businesses. The 882 Broadcasting Stations employ Radio Technicians and Operators. Radio factories are receiving millions of dollars of Government orders. Aviation, Commercial, Police, Ship Radio stations, Public Address Systems are other opportunity fields. The Government needs many Radio Technicians for good Civilian Jobs.

**EXTRA PAY IN ARMY, NAVY, TOO**

Men likely to go into military service, soldiers, sailors, marines, should mail the Coupon Now! Learning Radio helps men get extra rank, extra prestige, more interesting duty at pay up to several times a private's base pay. Also prepares for good Radio jobs after service ends. IT'S SMART TO TRAIN FOR RADIO NOW!

**Know Radio as Trained Technicians Know It**

My Course is thorough, practical. I give you basic training in Radio Theory and Practice -- the working principles of both Commercial and Military Radio equipment. You understand your work--know just what to do instead of just relying on mechanical ability to fix a few common faults and make a few simple adjustments. That's why many men who have been in Radio before enrolling report that my Course helped them make more money, win success. I train you, too, for Television, a promising field of future opportunity.

**Beginners Quickly Learn to Earn \$5 to \$10 a Week Extra in Spare Time**

Nearly every neighborhood offers opportunities for a good part time Radio Technician to make extra money fixing Radio sets. I give you special training to show you how to start cashing in on these opportunities early. You get Radio parts and instructions for building test equipment, for conducting experiments that give you valuable, practical experience. My 50-50 method of training--half with Radio parts I send you, half studying my Lesson Texts--makes learning Radio at home interesting, fascinating, practical.

**MAIL THE COUPON**

Get my Sample Lesson and 64-page Book "Rich Rewards in Radio" at once. They're free. See what Radio offers you as a skilled Radio Technician or Operator. Learn how practical I've made my Course. Read letters from more than 100 men I have trained telling what they are doing, earning. Mail the Coupon NOW--in an envelope or paste it on a penny postal.

J. E. SMITH, President, Dept. 26X National Radio Institute Washington, D. C.



Mr. J. E. Smith, President, Dept. 26X National Radio Institute, Washington, D. C.

Mail me FREE, without obligation, Sample Lesson and 64-page book "Rich Rewards in Radio," which tells about Radio's opportunities and explains your 50-50 method of training men at home to be Radio Technicians and Operators. (No salesman will call. Write plainly.)



OH BILL-- I'M SO GLAD I ASKED YOU TO FIX OUR RADIO. IT GOT YOU STARTED THINKING ABOUT RADIO AS A CAREER, AND NOW YOU'RE GOING AHEAD SO FAST

OUR WORRIES ARE OVER. I HAVE A GOOD JOB NOW, AND THERE'S A BIG FUTURE AHEAD FOR US IN RADIO

Name ..... Age .....

Address .....

City ..... State ..... 14 X 1

# RADIO-CRAFT

Incorporating

**RADIO & TELEVISION**

**HUGO GERNSBACK**  
Editor-in-Chief

**HARRY CONVISER**  
Managing Editor

**G. ALIQUO**  
Circulation Manager

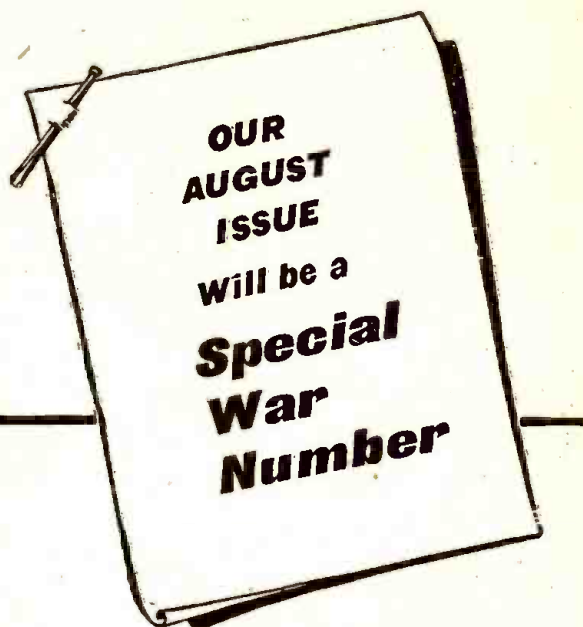

**Contents JULY, 1942 Issue**

**VOLUME XIII -- NUMBER 11**

Mailbag .....	644
Editorial: A Great Radio Opportunity..... Hugo Gernsback	647
The Radio Month in Review.....	648

## SERVICING

How to Build a <i>Substitutionalyzer</i> .....	Benjamin Kroll	650
Curing Instability in Receivers.....	James Gibbons	652
Putting Old Sets to Use Again.....	Harry S. Bixby	653
Radar Laboratory Needs Servicemen.....		654
Making a Fluorescent Display .....	Harold Davis	655
How WPB Tube Curbs May Affect Serviceman .....		657
<b>RADIO SERVICE DATA SHEET:</b>		
No. 324 Lafayette FE 250 Series.....		658
Service Questionnaire with Answers.....	Willard Moody	660
Extending 3-Volt A.C. Meter Range.....	D. V. Chambers	661
Operating Notes .....		661

## SOUND

War Use of Records Improves Tonal Range.....		662
Records Solve Overseas Language Problems .....		662
RCA Sound Installations Exceed Rate of 5 a Day.....		663
An ALL-Purpose 12-Watt Amplifier .....	Roger Harrington	694

## TEST INSTRUMENTS

Making a Vibrator Tester .....	H. L. Carpenter	664
Condenser-Testing Adapter .....	J. Langham	665

## ENGINEERING

Mutual Inductance .....	T. H. Turney, Ph.D.	666
Transmitter Adjustments.....	Willard Moody	668

## EXPERIMENTERS

Static in Car Radios Traced to Tire Friction .....		671
Making a Code-Teaching Machine.....	B. Bernstein	672

## FM

26 FM Commercials on Regular Schedule .....		674
Melting Sleet from FM Dipole .....	Kenneth Gardner	675
FM Antennas .....	Samuel M. Wertheimer	676

## INVENTORS

Attic Inventor's Contributions to Science .....	Benjamin F. Miessner	678
A Radio-Electric Balance.....	V. Edwin Janis	680

## DEPARTMENTS, ETC.

Mailbag .....	644
The Radio Month in Review.....	648
Operating Notes .....	661
RADIO SERVICE DATA SHEET (See Servicing).....	658
Latest Radio Apparatus.....	681, 693
Book Reviews .....	703

## RADIO & TELEVISION

Television Reception with Built-in Antennas.....	W. L. Carlson	682
Mystery Receiver Correspondence.....		685
A 2-4 Tube Progressive Receiver for 110 Vts. A.C.-D.C.—		
PART II .....	L. M. Dezettel, W95FW	686
Factors Controlling Man-Made Radio Interference .....	R. A. Shetzline	687
Microtube Transmitter .....	R. Muniz and A. Schlang	689
War Speeds Radio Research and Production.....		690
Offensive via Short-Wave.....	Charles J. Rolo	690
A Slight Disagreement With OPA .....		692
Radio Hook-Ups.....		694
Radio Patents Review and Digest .....		698
Home-Made Transceivers May Aid in Air Raids .....		701
Television in Color and Stereoscopic Relief .....		702



Published by Radcraft Publications, Inc. Publication office: 29 Worthington Street, Springfield, Mass. Editorial and Advertising Offices: 25 West Broadway, New York City. Chicago Advertising Office: RADIO-CRAFT, 520 North Michigan Avenue, Chicago, Ill.

RADIO-CRAFT is published monthly, on the first of the month preceding that of date; subscription price is \$2.50 per year in U. S. (In foreign countries, 75c additional per year to cover postage; Canada, 50c additional.) Entered at the post office at Springfield as second-class matter under the act of March 3, 1879. All communications about subscriptions should be addressed to: 29 Worthington Street, Springfield, Mass., or Director of Circulation, 25 West Broadway, New York, N. Y.



Foreign Agents:

London—Gorrings's American News Agency, 9A Green St., Leicester Square, W. C. 2, England.

Paris—Messageries Dawson, 4 Rue Faubourg, Poissonniere, France.

Melbourne—McGill's Agency, 179 Elizabeth St., Australia.

Dunedin—James Johnston, Ltd., New Zealand.



Text and illustrations of this magazine are copyright and must not be reproduced without permission of the copyright owners.



Copyright 1942 Radcraft Publications, Inc.



*New Target for Industry:*  
**More Dollars Per Man Per Month in the  
 PAY-ROLL WAR SAVINGS PLAN**



**TO WIN THIS WAR**, more and more billions are needed and needed fast—**AT LEAST A BILLION DOLLARS A MONTH IN WAR BOND SALES ALONE!**

This means a *minimum* of 10 percent of the gross pay roll invested in War Bonds in every plant, office, firm, and factory in the land.

Best and quickest way to raise this money—and at the same time to “brake” inflation—is by stepping up the Pay-Roll War Savings Plan, having every company offer every worker the chance to buy **MORE BONDS**.

Truly, in this War of Survival, **VICTORY BEGINS AT THE PAY WINDOW.**

If your firm has already installed the

Pay-Roll War Savings Plan, *now is the time—*

1. To secure wider employee participation.
2. To encourage employees to increase the amount of their allotments for Bonds, to an average of at least 10 percent of earnings—because “token” payments will not win this war any more than “token” resistance will keep the enemy from our shores, our homes.

If your firm has not already installed the Pay-Roll War Savings Plan, *now is the time to do so.* For full details, plus samples of result-getting literature and promotional helps, write, wire, or phone: War Savings Staff, Section E, Treasury Department, 709 Twelfth Street NW., Washington, D. C.

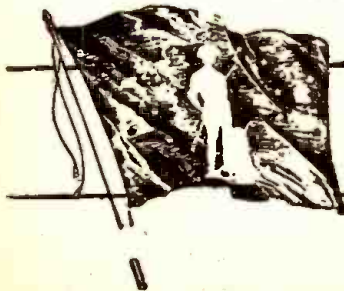

## U. S. War Savings Bonds

This space is a contribution to America's all-out war program by

**RADIO—CRAFT**

How to Step Up  
**SYLVANIA**  
**SERVICEMAN**  
**SERVICE**  
 by  
**FRANK FAX**



FOR some time Sylvania has been trimming its line of tubes so as to ease the replacement problem. In many cases, by multiple etching, we've combined two or three tubes in one.

That means that on many service calls where formerly you needed several types of tubes, you can now do a good job with just one type.

But that's not all. Several slow-moving tubes have been lopped off. That should speed up turnover and streamline your inventory.

To help you get the maximum use and benefit out of these changes, we've prepared a Tube Simplification Chart. This gives a complete list of the Sylvania Tubes for which replacements are available, along with the substitute best adapted for each.

These charts are available at your local jobber's. Better get one right away so you can put your tube stocks on a war footing now.

And while you're at it, take a good squint at that line-up of punchy sales helps below. Check off the ones you need and see your jobber about them. If he can't supply you write to me in care of Hygrade Sylvania, Emporium, Pa. Dept. C-7

- |  |  |
|--|--|
| 1. Window displays, dummy tube cartons, timely window streamers, etc. (From your Sylvania jobber only) | 16. Technical manual                         |
| 2. Counter displays  | 17. Tube base charts                         |
| 3. Electric clock signs  | 18. Price cards                              |
| 4. Electric window signs   | 19. Sylvania News                            |
| 5. Outdoor metal signs   | 20. Characteristics sheets                   |
| 6. Window cords  | 21. Interchangeable tube charts              |
| 7. Personalized postal cards   | 22. Tube complement books                    |
| 8. Imprinted match books   | 23. Floor model cabinet                      |
| 9. Imprinted tube stickers   | 24. Large and small service carrying kits    |
| 10. Business cards   | 25. Customer cord index files                |
| 11. Doorknob hangers   | 26. Service garments                         |
| 12. Newspaper mats   | 27. 3-in-1 business forms                    |
| 13. Store signatory  | 28. Job record cards (with customer receipt) |
| 14. Billheads  | 29. "Radio Alert" Post-cards                 |
| 15. Service hints booklets   | 30. Radio Caretaking Hints to the Housewife  |

**SYLVANIA**  
 RADIO TUBE DIVISION  
 HYGRADE SYLVANIA CORPORATION

MR. DEAN GOES TO TOWN

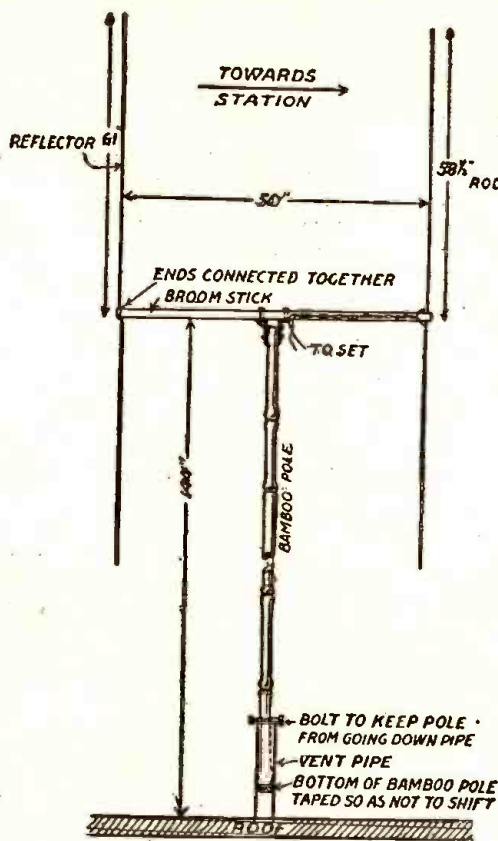

TELEVISION AND F.M. DI-POLE

THIS IS USED MOSTLY FOR THE 50-56 MCS TELEVISION BAND

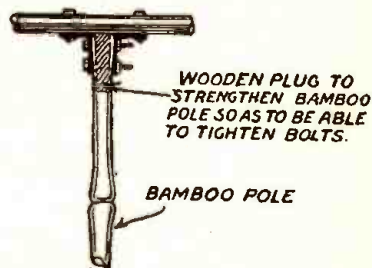

EQUIPMENT

- 2- BRASS OR IRON WELDING RODS 61"
- 2- " " " " 58"
- 1- 12' BAMBOO POLE & 4 WOODEN PLUGS.
- 1- BROOM STICK
- 2 3" ANGLE IRONS
- 4 2 1/2" STOVE BOLTS.

NOTE - ONE 3/8" WELDING ROD AND ONE 3'-1/8" WELDING ROD SOLDERED TOGETHER TO FORM RODS. TWO HOLES WERE DRILLED IN EACH END OF THE BROOM STICK AND THE ROPES INSERTED

Dear Editor:

My wife's article, "Television and the School Room" which appeared in the August 1941 issue of *Radio & Television* and for which she won a year's subscription has been a source of ribbing to me ever since.

The fact that you have been showing FM dipoles in your recent issues, gives me a chance to get back at her by suggesting how either FM or television dipoles can be made at a low cost.

The enclosed drawing shows one of my television dipoles that can also be used for FM. It is easily made, very light in weight causing no damage to a roof, and most of all costs about the same as a doublet aerial. Although the cost of iron or brass welding

rods would be more expensive now, the whole dipole including 100' of twisted pair lead-in wire only cost me \$1.25 last fall.

- \$ .95 100' twisted pair lead-in
- .25 four welders rods
- .04 two 3" angles
- .01 four stove bolts

\$1.25

Wm. A. DEAN,  
 Chicago, Ill.

Dear Mr. Dean: We assume that Mrs. Dean is letting you read her copies of *Radio-Craft*. Therefore we'll try to even the score by beginning a subscription for you when hers expires. We trust you will let her read your copies.—Editor.

R&T FOR THE AMATEUR

Dear Editor:

I happened to be reading some back issues of *Radio-Craft* and *Radio & Television*, when I ran across an article in the "Mailbag" about "Keep R-C for the Servicemen" (*Radio-Craft* for Jan.-Feb. 1942) by Mr. Reed.

From what I gather from his article, he has been strictly a serviceman. I should like to know what radio communications in our war today would have been if we had not had radio amateurs to explore and experiment and open this field up to the industries. Amateurs developed the short waves clear down to 10' meters, then the Government came in and seized the short waves, after the amateurs had proved that S-W communications could be used across the oceans. They were put in 5 bands, but they didn't get sore about it, they just kept on experimenting and improved their equipment. A lot of their ideas are incorporated in present-day equipment.

I am not saying that servicing isn't important, but it isn't half as important as Radio Communications to our Armed

Forces in all parts of the world.

Yours for a swell magazine.

KEEP 'EM FLYING.

LOUIS CHOWNING,  
 Madison, Indiana.

AUTHORS PLEASE NOTE

Dear Editor:

I think yours is the best radio publication on the market at present, and I read each month's issue through several times before I get all the useful facts out of it. You might, if at all possible without making the production less interesting for the rest of us radio men, print more dope on audio-frequency distortion, compressor-expander A.F. amplifier and a slide-back vacuum-tube voltmeter using the 6E5 "Eye Tube" for the slide back. I would prefer that this work on 250-300 volts, with a 15-50 meg. scale.

WILLIAM LLOYD GEORGE REID,  
 Regina, Sask., Canada.

**COIL-FORMULA BOTTLENECK**

Dear Editor:

I have been constructing a superhet. receiver, and there is one problem that I encountered that has caused a bottleneck in the building of this set. This problem, which many other experimenters must have come across, is the one of finding the values for the High-Frequency Oscillator's coil and padder condenser. I have asked everywhere with no success, and it is beginning to look like there is no formula, and that I will have to use the slow method of trying all of the likely values until the right one is found.

My receiver uses a 465 kc. I.F., with 140 mmf. tuning condensers in parallel to 3-30 mmf. trimmers, and is to cover from approximately 535 kc. to 30 Mc. in six bands. As I have pre-wound mixer coils, it is necessary to make the oscillator coils track with them so the mixer coils can remain as they are.

With the exception of "The Radio Amateur's Handbook," I have found no hint of any kind to the answer of this problem, so I would appreciate it very much if you could supply the formula, or recommend a publication on this matter.

WILLIAM F. SANTELMANN, JR.  
Washington, D. C.

(Formulas for calculating coils involve a number of physical factors and are not simple, but tables and graphs are available which simplify such calculations. Padding condensers likewise present no great problems to radio engineers. These calculations, however, are too technical for the average experimenter, who would do well to follow standard designs.—Editor)

**TOBACCO-TIN HEARING AID**

Dear Editor:

It may be of interest to you to know that I have been in need for a hearing aid for quite a while, but could not afford to get one. Then a friend told me about the article "A Tobacco-Tin Hearing Aid" by Samuel B. Simer, which appeared in the March issue of *Radio-Craft*. I only hope it will fill my needs. I have had an ear specialist "chart" my hearing and give his rather expensive advice. Now I can go ahead with constructing the aid.

GEORGE GARRETT,  
Weiser, Idaho.

**ALERT READER**

Dear Editor:

In *Radio-Craft* for May 1942, page 569, "The 'Lunch Box' Radio Receiver" was first printed in *Popular Mechanics* for February 1937 on pages 258, 259 and 152A, and was then the "Hurricane Emergency Receiver." So it is not a new Hook-Up. Your potentiometer across the 6 V. "A" battery is not printed (should be 5000).

ROBERT B. McCULLEY,  
Long Beach, Calif.

**A JOB FOR ANYBODY**

Dear Editor:

Will you please tell me what sound system studio, radio phonograph store, theater talkie supply company, or radio-sound-television shop, situated in Chicago, would really be able to rebuild and convert a silent 16mm home toy motion-picture projector? I would like to have mine converted into any home-made 16mm Filmgraph disc talkie film and regular sound-on-film with special rebuilt-in sound head reproducer attachment equipment.

Yours for Victory,  
TED MARYANSKI,  
5002 N. McVicker Ave.,  
Chicago, Illinois.

**Radio-Craft's Youngest Contributor**

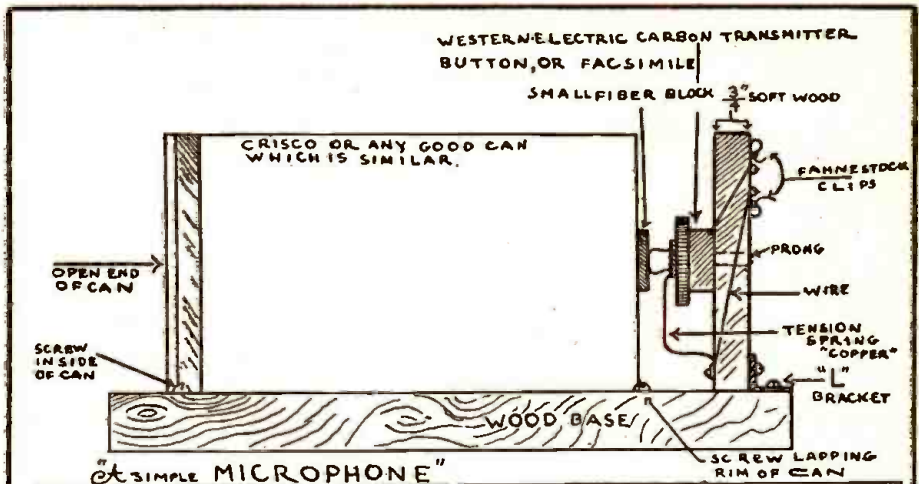

The Kink Editor:

*This is a simple microphone which is very sensitive, and which will produce sound fairly well. It may be connected in series with a 6 volt battery and the primary side of a doorbell transformer and the secondary may be connected with a speaker or phones.*

Address: 510 Rainier Ave.  
Flagstaff, Ariz.  
Respectively yours,  
Billy Hopkins.  
Age 12

Dear Billy:

We were very glad to receive your contribution and as you see we are publishing it in the front section of *Radio-Craft* rather than in the Kink Section. Your drawing, which we reproduced exactly as you made it, is excellent.

Of course you know that while the transmitter button will work, a facsimile will

not. We believe that soon you may be able to add at least one stage of amplification to your microphone. So that you may get in touch with radio developments we are entering your name for a year's subscription to *Radio-Craft* beginning with this issue. We hope to hear from you again soon.

Sincerely,

Editor

**PAGING MR. GUTCHMAN**

Dear Editor:

In your April issue, page 451, you published a letter *Crystal Detector to the Fore!* signed by Eugene R. Gutchman, who omitted his address. If you get his address give him mine or run an answer in your next issue. Thanks.

E. H. HEINTZE,  
Box 764,  
Elko, Nevada.

**WANTS R-T FEATURES**

Dear Editor:

I am happy to have this opportunity to express my opinion concerning whether or not *Radio-Craft* should be an exclusive Serviceman magazine. Personally, I feel that since *Radio-Craft* has incorporated *Radio & Television* (which I believe was one of the finest magazines published for the experimenter), it is obligated to the readers of that magazine to include in the combined issue at least the most popular departments and features of it. I feel that those articles dealing with construction and theory of amateur equipment should not be excluded from your future issues. Likewise, the radio experimenter departments would be sorely missed, should they also be eliminated. Although the war has had a very decided affect on radio as a hobby, as long as any equipment can be scraped together, there will be radio experimenters.

JAMES ALEXANDER,  
Terre Haute, Ind.

**LONGER PLAYING RECORDS**

Dear Editor:

For years back there have been a number of new systems and materials used for recording purposes which were better in many ways than the standard record. Now we have your article on the paper disc recorder in the May issue.

Why is it that the public can't buy records that will play for 30 minutes or an hour? I would like to put longer compositions on and let them run without a break, but all we can buy anywhere is the standard 12-inch record which could be had 30 or 40 years ago, with only added improved reproduction since radio became popular.

H. WILLS,  
Toronto, Canada.

Dear Mr. Wills:

Your complaint is justifiable and should be a challenge to the record industry. Admittedly 4½ minutes of playing time does not permit a sufficient amount of continuous recording for the music lover. Whatever the technical difficulties which might have existed with acoustic reproducers, current developments indicate that with the lightweight pickups now available a greater number of lines-to-the-inch can safely be used in the recording process to extend the playing time to six or seven minutes, without resorting to slower record speeds or special equipment. After the war is won we may expect to see numerous commercial developments of this kind.

—Editor



## AGAINST THE BACKGROUND OF EXPERIENCE

Against the background of millions of radios built for American homes, RCA now is building radio apparatus to strengthen the worldwide life-lines of American communications ashore, afloat and aloft. Radio has gone to war!

Almost the entire development of radio as we know it took place during the two decades between the last war and this one. During that time, RCA Laboratories worked unceasingly to perfect existing devices and to invent new ones. Out of this research came the finest civilian radio equipment the world has

ever seen...and the finest *military* radio equipment! For the RCA Manufacturing Company is today on a war footing.

Some day, when peace returns, against this dual background of manufacturing experience in peace and war, RCA will turn from military to civilian radio—and gear its production to build new radio and television sets for the home—post-war radios designed to incorporate the latest scientific lessons and discoveries made in RCA Laboratories.



BUY  
U.S. WAR  
BONDS

## Radio Corporation of America

PIONEER IN RADIO, ELECTRONICS, TELEVISION

RCA Building, New York



# RADIO-CRAFT

Incorporating

RADIO & TELEVISION

"RADIO'S GREATEST MAGAZINE"

... *The Radio*  
*Paul Reveres*  
*Are Here* ...

## A GREAT RADIO OPPORTUNITY

By the Editor — HUGO GERNSBACK

IMMEDIATELY upon entering the war, the United States silenced all amateur transmitters. This happened on December 8, 1941. Several thousand radio amateur stations were allowed to continue operating because they were required for radio war emergency communication. However, on January 9th, the Federal Communications Commission, on behalf of the Defense Communications Board, closed down these amateur radio stations too.

Last month (early in June) the FCC announced complete new radio regulations—a revolutionary feat for the United States.

In a nutshell—and giving you only the barest outline of the important and complex new emergency radio service—the set-up will work somewhat as follows:

There is to be inaugurated immediately a *War Emergency Radio Service* (WERS), which will operate two types of stations: (1) Civilian defense stations embracing amateurs, experimenters, etc.; (2) State Guard stations, operated by State Guard members, etc. These services, it should be understood, are ONLY for emergency war communication. Both services are to operate exclusively on the present amateur radio wavebands: 112-116, 224-230 and 400-401 Mc. So far it does not appear that the 5-meter band has been allocated.

It should be understood that the WERS will be purely a Civilian Defense project which has nothing whatsoever to do with any amateur organization, either national or local. The plan is also revolutionary in the respect that instead of licensing individual operators, *the municipality will be licensed instead*. The municipality then will be responsible for the operation of all stations operating in the Emergency Civilian Defense Communication—whether they are fixed, mobile or portable.

It is contemplated that individual transmitters will be identified by special serial numbers. It has as yet not been determined what the individual calls will be or how they will be arranged—if by number, by call letters or otherwise. Each municipality will have a sort of supervisor called "*Radio Aide*"; or a Communications Officer, probably under the military command of the Citizens Defense Corps (CDC).

WERS operators will be carefully selected by the Radio Aide who is responsible for the personnel. The entire purpose of the set-up is to make certain that not only good radio men will be selected for the service but that there will be no question as to their loyalty. To this end, the Radio Aide will have a difficult task of not only selecting the technically best men available, but all the men will be investigated, not only for operating proficiency, but they also must furnish proof of citizenship, they must be fingerprinted, etc.

The entire service is to be so geared that in case of invasion, bombing, or other war upset or disaster, instant radio communication can be established when telephone or telegraph wires or cables are cut. By having a complete nation-wide WERS network, it can be readily seen that in case of bombing, invasion or military debacle, the emergency radio network will be able to function independently and smoothly.

That this is a most important and necessary undertaking in wartime can easily be visualized by what happened in France. When France was invaded in 1940, the Germans tried all sorts of tricks. They got hold of telephone lines, then called up the next town or village telling the Mayor that the Germans were heading for his town and had already surrounded it. The speaker then suggested that the population should immediately evacuate the city. As a matter of fact, most of these fake phone calls had no basis of fact, but they accomplished their purpose, that is, they threw many parts of the country into a terrific confusion—which was exactly what the enemy wanted. The War Emergency Radio Service would make such tricks most difficult, if not impossible.

It should be noted that many of these transmitters, either portables or mobile, will be operated by radio personnel who need not know the code. In other words, the service will largely be phone-operated, and the sets used will probably all be of the walkie-talkie type.

And here is the great opportunity for radio men of all classes and all ages. Whether you are a radio amateur, a radio serviceman, or a radio experimenter, you can do your bit for your country by volunteering for the new service. Thousands upon thousands of simple transmitter-receivers will soon be in operation. The transmitter may not have an input of more than 25 watts. For this reason, it will probably not carry more than 25 to 50 miles at the most, except under unusual conditions. Inasmuch as the CDC will not be able to get sufficient instruments or "gear", (as the amateurs call it), it is up to the citizens to supply the apparatus themselves.

Now it is a fact that almost every radio man—be he amateur or experimenter—has sufficient spare radio parts in his possession with which to build such a transceiver. *Radio-Craft* has described many of these in the past and will describe many more in the immediate future. In any event, those radio men who get on the scene first and enroll their services will no doubt become important links in the WERS.

It is not necessary that hundreds of dollars are spent in the building of such gear. *The main idea is, it must operate perfectly and must stay on its frequency*. No doubt every municipality very soon will be equipped with a special set of calibrating instruments by means of which the transceiver will be calibrated as to wavelength, and it is most important that the frequency shall not vary; this is one of the rigid requirements of the F.C.C. If this were not the case, there would be too much confusion in the resulting interference.

Sometime in July, every Civilian Defense Corps will have ready complete instructions and probably booklets giving all the information in connection with the WERS and other technical information necessary for the operation of transceivers.

In the meanwhile, the important thing is to get ready—to get your rig built—with all possible speed. Events are moving rapidly and it is quite conceivable that sometime during the year many of these units will go into action on an honest-to-goodness war basis.

Let radio men be ready for war and show the country what we can do.

## A Digest of News Events of Interest to the Radio Craftsman

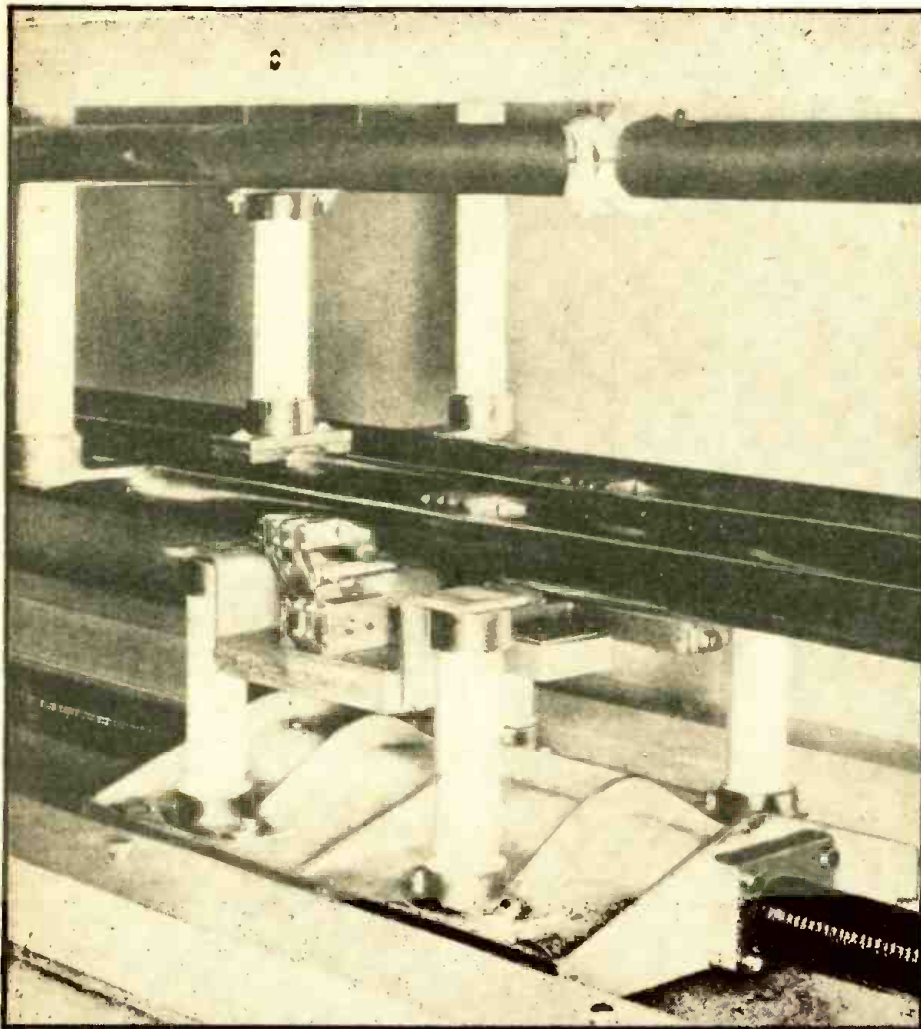

Motor-driven device for automatically tuning the power amplifiers to the desired frequency, a new development and one of the more important contributions to the unusual flexibility of the CBS short-wave plant.—Courtesy International Telephone and Telegraph Corp.

### CBS S-W NETWORK USES NEW DESIGN FEATURES

The two new 50,000-watt short-wave transmitters and the thirteen directional antenna arrays of the short-wave broadcasting plant of the Columbia Broadcasting System near New York were designed, manufactured and installed by associate companies of the International Telephone and Telegraph Corporation in co-operation with the CBS engineering staff. These are stations WCRC and WCBX which, along with 10,000-watt station WCDA, serve the "Network of the Americas," made up of 76 Latin-American stations, with programs from the United States.

The flexibility of the design permits any of the three radio-frequency assemblies to be connected easily and quickly with either of the two sets of modulating equipment and with any of the thirteen antenna systems. Two complete transmitters are normally operated simultaneously; for instance, one may be serving South America, the other, Europe. The third frequency, normally pre-tuned, is connected to a third antenna array and held ready for immediate service by means of the instantaneous frequency-change feature of this equipment.

This installation is the only one in which tuning of the higher power stages is continuously variable for the complete range from six to twenty-two megacycles from the front panel of the equipment. A motor driven "dolly" arrangement operating on a worm drive beneath each power amplifier

enables the attendant to tune any of the three amplifiers to the proper frequency in any of the six international bands automatically, and he may change frequencies quickly in an emergency should the frequency in use suddenly become "jammed."

The exciters which generate the radio-frequency current, the modulating units which superimpose the audio frequencies, and the power amplifiers which develop the 50,000-watt 100 per cent modulated R.F. power delivered to the antennas are completely interchangeable. Any exciter, any modulator and any amplifier may be combined in sequence as desired. Any power amplifier may be connected with any of the thirteen antennas systems by the turn of a wheel on the switching system. This method is superior to others.

Of the thirteen directional antenna systems, four direct a "beam" on the west coastal region of South America, three on the east coastal region of South America, one on South America generally, one on Mexico and Central America, one on Europe and three are reversible between Europe on one side and Mexico and Central America on the other.

This reversible feature is another interesting development. Three of the antennas may be reversed 180 degrees so that they serve Europe at certain periods and Mexico and Central America at others. This is accomplished by remote control.

### G.E. EXPANDS TRAINING ON RADIO AND WAR DEVICES

General Electric Company last month expanded its training program to teach military men and its own employees how to maintain in the field the great variety of war devices, many of them new and highly technical, which the company is making in vast quantities.

Vice-President Roy C. Muir, chairman of the company's education committee, explained that Navy men were being given instruction in the care of submarine propulsion equipment; British and Canadian as well as Army and Navy air men were being taught maintenance of airplane equipment for high altitude flying, and that both Army and Navy men are learning the care of radio equipment, searchlights, gun controls, airplane locators, and similar devices.

"Graduates of some of these courses are now in England, Hawaii, Africa, and India," said Mr. Muir. "The number is constantly increasing. The civilian engineers travel in trans-Atlantic and trans-Pacific planes and are glad to take many of the risks of soldiers to keep equipment functioning where it is needed.

"In the majority of courses, we are teaching teachers who will go out and train hundreds of others. Every effort is being made to keep instruction abreast or ahead of production to insure proper use of equipment when they reach the scene of action.

"This is a war of science. A new type of engineering is required. Electrical machines and circuits must be co-ordinated with highly complex mechanical mechanisms, optical systems and radio. Some entirely new things have been developed.

"All that has been learned in the last 20 years about electronics, frequency modulation, television, and high-frequency phenomena is now being applied to the airplane and warship. Light-weight instruments, generators, motors, complicated control systems, armament, and ignition systems have been designed to withstand vibration and to operate in planes from sea level to high altitudes under widely varying humidity and temperature conditions.

"Electrification of a warship has become much more complete and complicated. Automatic controls, shock-proof mounting, mine protection, radio communication, signaling and detection are among the things requiring highly trained men."

The principal war-training courses are being conducted in half a dozen of the company's plants where the products studied are manufactured. Smaller courses are under way at a number of Navy yards, air fields and aircraft factories.

An additional building is planned at one plant to house laboratories and classrooms for a new course in high-frequency phenomena to be conducted by the radio department. This will accommodate 100 engineers at a time. They will attend classes and laboratory sessions 54 hours a week and will also prepare outside work.

The first graduates of a course in the use of aircraft locators which General Electric organized for the Navy are now in the fighting areas. A similar course is being organized for the Army at another plant. Signal Corps men and civilian employees of the Army will study the latest developments in radio communication and detection.

In space once used to store home appliances, an aircraft armament school is under way. Classes will include Army Air Corps officers, G. E. engineers, and possibly engineers from aircraft manufacturers.

Instruction has been given for some time at another plant in the operation of the turbo-supercharger, which enables planes to maintain speed and power at high altitudes.

**FM LISTENERS PREFER SERIOUS MUSIC**

That FM listeners are more interested in Brahms than in ball scores was indicated by recent surveys in Philadelphia, Detroit, New York, Boston and Chicago, according to FM Broadcasters, Inc. The belief that persons have purchased FM receivers because they preferred the interference-free tonal fidelity of frequency modulation was shown in replies from set owners in "all income levels from elevator operators to bank presidents." Most of them were "average, middle-class folks."

The latest research was conducted by W53PH, of Philadelphia. Here is what they found after questionnaires from almost 500 FM listeners in all payroll brackets had been tabulated:

When offered a selection with virtually every type of radio program to choose from, 40.9% selected symphonic music as first choice. Classical and light concert music finished second and third with 12.7% and 12.0%, respectively. Popular music was named first choice by only 5% of those replying, while news, talks, and drama received less than 1%. The preponderance of second and third-place choices indicated that the taste for better types of music runs far ahead of any other types of radio programs.

Included on the ballot were popular music, ballads, Pan-American music, classical and popular vocalists, military bands, drama, sports and news—in addition, of course, to symphonic, classical, light concert and chamber music. But only the last four seemed to get Philadelphia FM listeners very excited.

**ZENITH SURVEY FINDS FM FUTURE PROMISING**

Three of the pioneer manufacturers of FM receivers—Zenith Radio Corporation, General Electric Company and Stromberg-Carlson Manufacturing Company—last month began a series of surveys on the future of FM broadcasting.

Zenith, the first of the companies to announce its findings, sent its questionnaires to all of FM's operating commercial and experimental stations and to holders of and applicants for FM construction permits.

The average FM station today, according to the Zenith survey, is on the air daily for eleven hours and twenty minutes. Although licensed to use 13,190 watts, it operates with only 5,950 watts because of incomplete equipment. The average FM station (to the extent of 59%) does not yet sell commercial time, but virtually all FM outlets expect to do so in the future. There is a lively prospect of new stations going on the air, despite curtailments, in August, September, and November.

Zenith officials sum up the outlook with this statement: "There is no denying that a continued war emergency will cut into available manpower, and the lack of equipment such as high-frequency tubes will tend to reduce schedules. But, from the consistent note of remarks, we do not expect to see them eliminated. The only shutdown discovered thus far was the experimental rig of a radio manufacturer. Personnel, it was said, was required for war work."

"The prominence of FM in the military picture promises much advancement and general spreading of knowledge of high-frequency radio among communications men. The FM broadcasters are smart to hold their forts so well. Peace will find them ahead in the greatest radio rush we have ever seen."

**ANNOUNCERS TO DESCRIBE NETWORK DELAYS**

Aiming at more intimate contact with the general public, Ray Diaz, chief announcer of the Blue Network, last month set a new policy whereby staff announcers will bring the radio audience closer to the technical side of network operations. The newly formulated instructions cover announcements in the case of program delays or cancellations because of technical difficulties.

Although the public has been given a glimpse of the inside of a newspaper, a motion picture and the inner workings of other industries, off-the-air radio operations have never been described because of the belief that the explanations would be too technical for the listener. It is now believed, however, that radio technique can be explained in simple language.

When a scheduled program did not go on the air on time because of a power failure, for example, the announcer traditionally followed a standard procedure and made an announcement about "conditions beyond our control" to precede the substituted program, thus leaving the radio audience curious as to the nature of the "conditions." Under the new policy announcers will explain what caused the program failure and how the problem is being handled, and then try to build the listeners' interest in the fill-in show—usually music—by giving some details of interest.

A recent broadcast from Hollywood failed to go on the air and, after the announcer's brief statement, an organ recital began without any further explanation. Under the new policy, the announcer would have explained that the program did not come East because of the failure of the equipment that reverses the flow of sound currents on the radio cables.

The previous program had been directed from East to West and the cables had to be reversed to transmit the scheduled program. After this explanation, the announcer would tell about the fill-in.

Another set of instructions will be put into practice as a result of suggestions made by patrons who were present at dance-band "remotes" during airings of the orchestra. Many persons were interested in the activity on the bandstand prior to the broadcast and in most instances their curiosity went unsatisfied. In the future announcers will take over the public address system a few minutes before air time and give a brief talk explaining that the network is about to broadcast the music and include a few details about the radio technique. They will say that the engineer on the stand is connected with the radio studio by a private line and will receive a signal when the studio has completed station identification. At signals from the announcer, as the latter will explain, the engineer will cut in the various microphones around the dance floor, this step-by-step procedure meanwhile being described.

**FLY OPPOSES PLAN TO SPLIT UP F.C.C.**

James L. Fly, chairman of the F.C.C., last month appeared before the House Interstate Commerce Committee and stated his objections to a bill that would revise the communications law and separate the commission into two divisions, one to handle public communications and the other to supervise private communications.

The present was no time "to disrupt a war agency" to "effect a basic reorganization," Mr. Fly said. "The best thing to do is to leave the problem alone."



P. R. Kalischer, metallurgist, inserts in socket a new electronic tube he has developed at Westinghouse Electronics Laboratories as a "watchdog" of production to help reduce spoilage of parts for planes, tanks, guns and other machines.

**ELECTRONIC TUBE COMBATS WAR MACHINE RUST**

A new electronic "tool" to reduce spoilage of war-machine parts has been developed at the Westinghouse Research Laboratories in Pittsburgh, it was disclosed last month. This device is a dewpoint recorder, which can detect minute quantities of moisture in gases 1,000 times as dry as summer air.

The essential part of the recorder, developed by Philip R. Kalischer, Westinghouse metallurgist, is an electronic tube. It can detect as little as 4/1000ths of 1 per cent of water vapor in these gases and is accurate to within one degree of temperature.

All steel machine parts used in planes, tanks and guns require hardening in heat-treating furnaces through which such gases as hydrogen are forced to exclude air ordinarily containing enough moisture to rust hot steel, Mr. Kalischer explained.

"But even with this technique, moisture can not be entirely excluded from the furnaces, since traces of oxygen present in the gases combine with the hydrogen to form water vapor," he said. "To overcome this obstacle, blotterlike drying agents such as aluminum hydroxide are placed in tanks through which the gases flow on their way to the furnaces."

The dewpoint recorder tells when the gases require drying, and it also tells when a drying tank becomes saturated and will absorb no more moisture. The furnace gases must then be routed to a new drying tank.

The contents of the recorder's tube are similar to a radio rectifier tube, which is used to transform alternating current to direct current. But the radio tube contains no gases, whereas gas from the heat-treating furnace flows continuously through the recorder's tube.

Mr. Kalischer explained that electrons (negatively charged electrical particles) travel from the tube's hot filament to a metal plate. As long as dry gas passes through the tube, electrons flow steadily, producing an unvarying electric current in an external wire circuit. But when water vapor is present in the gas, some of the electrons adhere to the water's oxygen atoms, reducing the electric current. By measuring the flow of current, a meter indicates the moisture in the gas.



Mr. Kroll holding the unit designed and built by him.

# How to Build a Substitutionalyzer

BENJAMIN KROLL

**M**ANY servicemen have found the simple substitution box useful for determining the proper value of resistance or capacity that would put a radio set in working order. But by including a buzzer-type signal generator and a neon tube in the same box we get the *Substitutionalyzer*—a test instrument that makes use of all the components, separately and together, to yield many tests otherwise not easily obtained. This unit is especially useful to the beginner in service work, but even an old-timer will find it well worth the space it occupies in his service kit for the number of uses to which it can be put.

The *Substitutionalyzer* was built in a 3-inch by 5-inch index-card box, which the reader will recognize from the photographs as the cedar type purchasable in 5- and 10-cent stores for twenty cents. Although we considered shielding the inside walls of the box by gluing in tin foil or abandoned condenser foil, we decided that it would be more patriotic to contribute the foil we had on hand to the war effort. (If shielding is found desirable the inside walls may be painted with colloidal graphite, as explained in the June, 1942, issue of *Radio-Craft*, page 589—*Editor*.)

Top and front panel views of the *Substitutionalyzer* showing placement of parts.

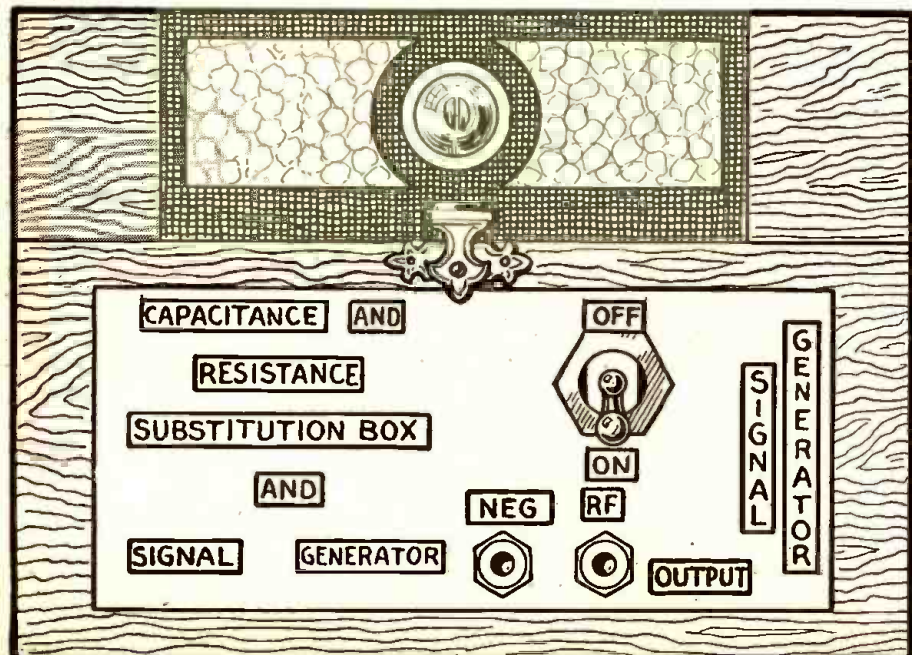
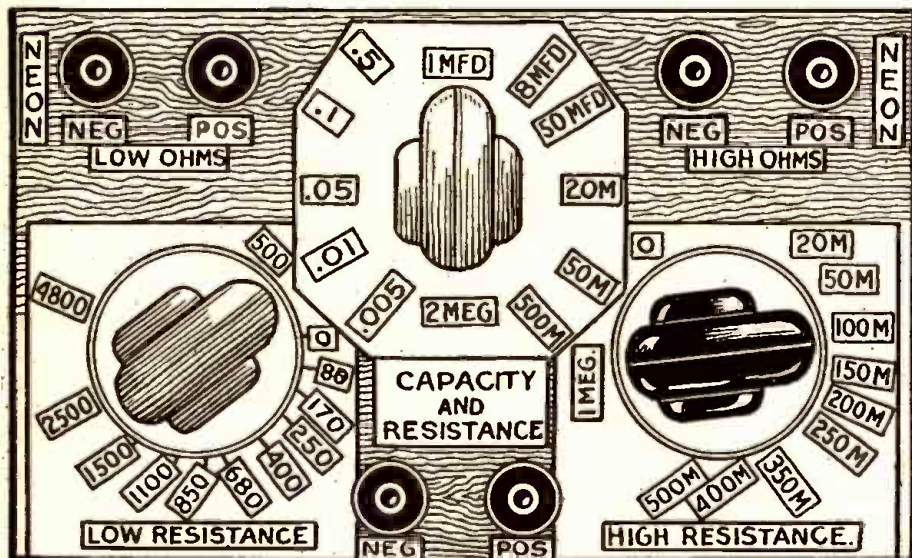

As can be seen from the drawings the *Substitutionalyzer* contains two wire-wound volume controls which are used for variable resistances. One is 0-5,000 ohms, the other 0-2 megohms. The 5,000-ohm control is mounted under the cover on the lower left-hand side, the 2 meg. control is mounted in the same way on the right-hand side. These variable controls are connected to two sets of jacks, as shown in the diagram.

Next a 12-tap rotary switch is mounted under the cover in the upper center. To each tap is soldered the *positive* of the two electrolytic condensers and the leads *not* marked "outside foil" of the other six condensers. The remaining taps are used for the four fixed resistors, with values as shown. The negative leads of the electrolytic condensers, the condenser leads marked *outside foil* and the leads of the resistors are twisted together and brought out to a common jack, this common tap on the switch being the positive connection.

To calibrate the variable resistances connect an Ohmmeter in series with each and select various reference points along the scale, marking the values which later can be inked in. By substituting different values in the circuit a "dead" set can be made to play, and the performance may even be improved by trying a value of condenser or resistor different from that specified in the original schematic. By using a wire jumper between the fixed resistor and variable resistance, as the dotted line on the diagram shows, any resistance value from 0 to 4 megohms may be inserted with the added safety of the fixed resistors in series with the variable control to protect it from burning out in case of a possible overload.

The buzzer signal-generator is built into the lower right-hand side of the box. It consists of an ordinary house buzzer, a flashlight cell, a small condenser, a switch and two tip jacks. The diagram shows the simplicity of the circuit. Broken coils and open circuits can be detected. As the output lead is touched to different parts of the circuit, the buzzing is heard in the speaker. When the buzzing stops an open circuit is indicated. By working from stage to stage the trouble is isolated and corrected. A pair of shielded probe leads should be used for the above tests to keep the output from radiating in all directions, thus preventing pickup by various parts of the set under test.

The neon is built into the front center of the cover, one of the leads going to the negative of one volume control, and the other to the positive of the other volume.

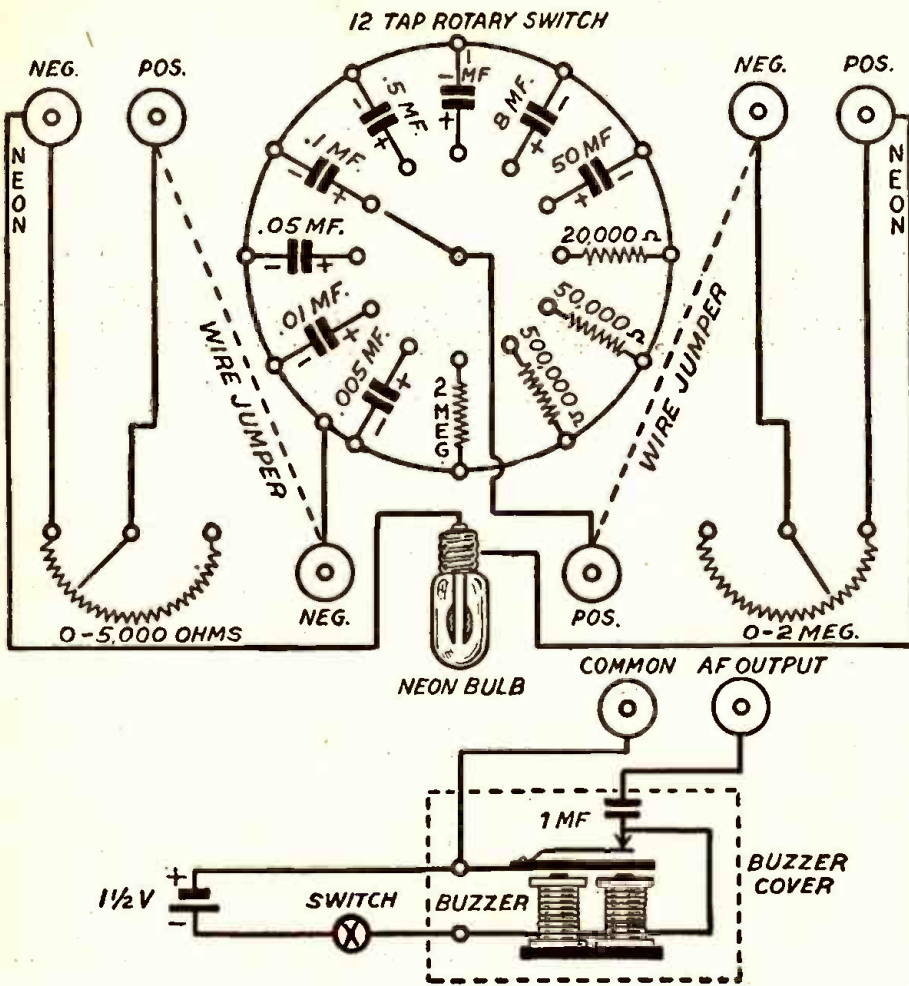

Circuit diagram of the Substitutionalyzer.

control. The neon is used for testing polarity of circuits, and for type of current, A.C. or D.C. One plate of the neon will light if the current is D.C.; both will light on A.C. The neon can also be used as a continuity tester by using the line current in series as current source. The combination of the different parts lends itself to other tests. For instance, by attaching the test prods to the output of the receiver (just ahead of the output transformer), the neon will serve as an output meter. Note results just as if a meter were being used. The neon will glow brighter as the set is correctly aligned. Or, the unit can be converted into a leakage tester. Connect the neon in series with the 2-meg. resistor to a D.C. source, a 90 V. battery or receiver "B" supply. Touch the leads of the condenser to be tested across the neon terminals. If the neon flashes on and off the condenser is good. If the condenser is leaky there will be no response from the neon bulb.

LIST OF PARTS

CONDENSERS

- One Cornell-Dubilier, dry electrolytic, type BR, 50 mf. 50 V. W. V.
- One Cornell-Dubilier, dry electrolytic, type BR, 8 mfd. 450 V.
- Cornell-Dubilier paper condensers, type DT
- One 1. mfd. 400 V. D.C.
- One .5 mfd. 400 V. D.C.
- Two .1 mfd. 400 V. D.C. (One for buzzer signal generator.)
- One .05 mfd. 400 V. D.C.
- One .01 mfd. 400 V. D.C.
- One .005 mfd. 600 V. D.C.

RESISTORS AND VARIABLE CONTROLS

- One I.R.C. wire wound control, type W-5000, 5000 ohms
- One I.R.C. metallized control, type 13-139, 2 meg.

- One I.R.C. insulated resistor, type BT-1, 20,000 ohms
- One I.R.C. insulated resistor, type BT-1, 50,000 ohms
- One I.R.C. insulated resistor, type BT-1, 500,000 ohms
- One I.R.C. insulated resistor, type BT-1, 2 meg.

MISCELLANEOUS

- One Yaxley single gang 12-tap switch, type 3100
- Eight tip jacks (4 red and 4 black)
- One G.E. neon, 1/4-watt, 105-125 volts, type T4 1/2
- One shielded pair of test leads and prods
- One SPST toggle switch (for buzzer-generator)
- Three pointer knobs
- One cedar fling cabinet (5 in. x 4 in. x 3 in.)
- One large flashlight cell

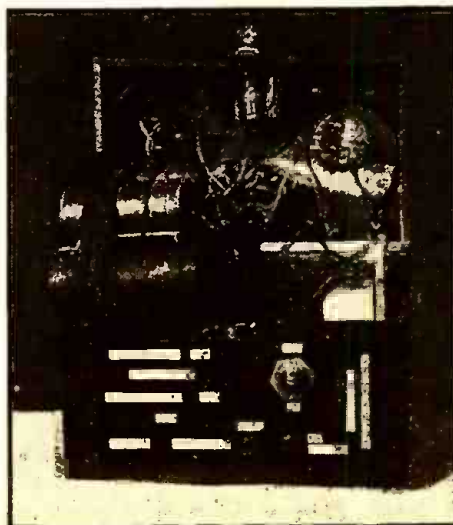

Substitutionalyzer with cover raised to show internal arrangement of parts.

**BOOST**  
*Service Profits*

LOWEST PRICES...  
FASTER DELIVERY at  
**RADOLEK**

LARGEST STOCK OF  
EVERYTHING IN RADIO



Thousands of progressive servicemen rely on Radolek for their complete requirements of repair materials. Radolek has in stock for prompt delivery replacement parts to repair any radio—every type of tube, transformer, speaker, condenser, volume control, resistor, auto radio accessory, etc. Everything you need at lowest prices. You get what you want when you want it—Radolek understands service problems—gets your order to you in double-quick time. Buying from Radolek means Greater Values, Better Service and More Profits. The big new Radolek Radio Service Guide is yours FREE for the asking. Send for your copy today!

**RADOLEK P. A. SYSTEMS FOR EVERY REQUIREMENT**

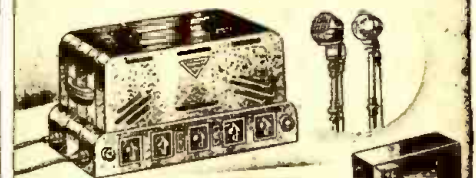

Thousands of successful Radolek P.A. installations are proof of quality, superior design and top performance. Complete systems for permanent, portable or mobile use—wide choice of microphones, speakers and related equipment. Radolek P.A. Systems give you more for your money in Performance, Styling, Dependability and Reserve Power. Select the P.A. apparatus you need from Radolek's big new FREE catalog.

**RADOLEK REPAIR SERVICE**

Let Radolek repair your damaged or burned out transformers, coils, speakers, test equipment, etc. Many items cannot now be replaced and therefore repairing is the only alternative. Trained craftsmen, using precision tools and factory methods, assure perfect jobs equal to new. Write for prices or better still, send in any article to be repaired. It will be handled promptly.

**FREE!**



SEND FOR NEW FREE  
RADIO SERVICE GUIDE

RADOLEK CO., Dept. C-53  
601 W. Randolph St., Chicago, Ill.

Please send the Big FREE Radio Service Guide.

Name .....

Address .....

DEALER  SERVICEMAN  SOUND ENG

**SAVE AT RADOLEK**

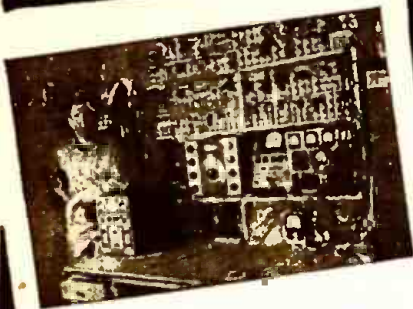

FLOYD WALVOORD RADIO SERVICE  
Nebbraska  
Nickman.

"While I have only been using N.U. Products for three years, I find them to be of the finest quality. National Union's Equipment Plan has enabled me to have the best equipment available and heartily recommend N.U. to everyone."

WHERE YOU FIND  
**NATIONAL UNION**  
YOU FIND BETTER  
**RADIO SERVICE**

**PREMIUM**  
*Quality*  
**TUBES**



**BATTERIES**



**CONDENSERS**

also *Transmitting tubes, panel lamps, cathode ray tubes, exciter lamps, sound equipment, photo electric cells, sound accessories, dry batteries, flash light bulbs.*

NATIONAL UNION invites . . .

All radio service dealers to enjoy the benefits of the N. U. Shop Equipment Plan. The latest in tube testers and test equipment are available to you . . .

More than 60,000 completed deals prove the success of this plan. Investigate now.

Ask Your N. U. Distributor or Write



**NATIONAL UNION**  
**RADIO Corp.**

57 STATE ST., NEWARK, N. J.

# CURING INSTABILITY IN RECEIVERS

JAMES GIBBONS

**A**MONG the many faults which a receiver can develop, and one of the hardest to locate, is that of instability. It may be just perceptible, or immediately obvious, and ranges from the hardly audible "motorboating" at full volume to a violent succession of whistles as the tuning condenser is rotated.

The cause of such instability may be a change of circuit conditions in either the A.F., R.F., or I.F. circuits. It is known that this effect is caused by unwanted coupling between two or more successive circuits or by self-oscillation of a particular stage.

Whistles in superheterodyne receivers need not be regarded with grave concern in every case. All receivers of the low I.F. type and particularly those without a pre-selector stage have self-generated whistles on the broadcast band at least, usually on that part of the band which coincides with a wavelength equal to the 2nd harmonic of the intermediate frequency. This is due to a beat effect between the output of the second detector and a received signal. These self-generated whistles, or image frequencies, have to be considered when the receiver is designed, because very little can be done about it afterwards.

## TYPICAL CAUSES

The cause of instability in a receiver may be fairly simple, such as wrong operating voltages on I.F. or converter tubes. Perhaps it is due to screen-grid bypass condensers having become open circuited, or to the shielding of coils or leads which have become disconnected or which have developed high resistance to ground. Metal tubes may develop queer tricks. The connection between the metal coating and the cathode sometimes works loose and often provokes acute instability. Anything, therefore, which tends to reduce the efficiency of inter-circuit shielding or decoupling or introduces unwanted coupling by high-resistance contacts, must be suspected when normal stability is affected.

A systematic check of all the possible causes, starting with the simplest, is the best procedure. First of all it should be noted what type of instability has developed. Is it present all the time or only on the weaker stations? Does it occur only at certain positions of the dial? Does the set seem lively, etc? A careful test will often give a clue to the whereabouts of the trouble. For instance, unstable conditions which show up only at certain positions on the tuning dial are frequently caused by poor contact to the different rotor sections of the ganged tuning condensers. If this is suspected, and, for that matter, at any time a set is being given a "surface" overhauling, these contacts should be removed, and their surfaces cleaned. On replacing, the contact tension should be increased, and a smear of vaseline applied to the bearing surfaces. It is also advisable to examine carefully the continuity of the ground wire. There are many commercial superhets that do not function properly when worked without a ground, while nearly all high-gain TRF sets develop self-oscillation at the high-frequency end of the band without the stabilizing influence of a ground.

## VISUAL INDICATIONS

Keen visual observation has always been a necessary asset to rapid fault-tracing in

radio receivers. Quick perception will often reveal in a fraction of the time faults which could be found only in a general way by much tiresome routine testing. It is therefore good practice to make a careful examination for obvious defects. Be always on the lookout for traces of electrolyte around the bases of tubular electrolytic condensers. This sometimes dries and makes detection difficult, but it always impairs good contact, and increases the apparent power factor of the condenser, causing reduced general performance, abnormal hum level and reduced B voltage in condensers; and low volume, thin reproduction, and instability in the case of filter condensers. Press all coil cans, tube shields, etc., firmly down on their bases, giving them at the same time a twisting motion to make sure of a good biting contact. Be suspicious of all ground lugs, making sure of their electrical connection to the chassis; remember that high resistance contact to ground of shielding and decoupling components has been productive of more cases of instability than any other single cause. Check carefully all soldered connections to sockets and decoupling components. It takes very little time to resolder many joints, while a poor one which goes undetected is probably the most difficult of all faults.

Many rough, but informative, tests can be made before the chassis is removed from the cabinet. If the main filter condenser is suspected of being open-circuited, a substitute can be tried between the B+ side of the output transformer and chassis, or between the screen grid terminal of an output pentode and chassis. Sometimes, too, stability can be restored by touching the metal coating of one of the tubes. The implication here is obvious, and that particular tube and stage should be checked without delay. Screen-grid decoupling condensers can likewise be temporarily connected between the appropriate contact on the socket and chassis, if the mechanical design and layout will permit. If not, remove the chassis right at the start and work in comfort. Always re-arrange as before any inter-circuit wiring disturbed during tests. This is important, as neglect to do so may provoke further instability, and even A.F. circuits are sometimes quite critical.

## STRAY COUPLING

Volume-control wiring should always be treated with respect. The volume-control potentiometer in many sets is used as, or part of, the signal diode load resistance; it is therefore in circuit with the high gain end of the I.F. amplifier and second detector. Any careless derangement of its attendant wiring may cause unwanted self-generated whistles by reaction between nearby leads carrying R.F. currents. The writer knows of at least one commercial superhet which was cured of a nasty whistle by altering the wiring to the volume control, thereby eliminating acute 2nd-I.F. harmonic feedback. It is so often the small things which make the big differences.

Open-circuited secondaries are another cause of greatly reduced performance, together with lively "chirps" all over the scale. A voltage and current test will, however, always give a clue to this defect, as it removes the bias from the succeeding

(Continued on page 688)

# PUTTING OLD SETS TO USE AGAIN

HARRY S. BIXBY

**W**ITH the discontinuance of production of receivers many older sets that have been in retirement will be brushed up and put back into service. Probably some will need only tubes to put them into good operating condition, but there are others which will require a general overhauling to get the best out of them. This overhauling should be done systematically and may well be divided into four classes: R.F., A.F., power supply, and miscellaneous (speaker, wiring, etc.). Some of the most common sources of trouble will be described here, together with possible remedies.

**R.F.—Corroded contacts on rotor of variable condenser:** Clean thoroughly with carbon tetrachloride (it is a good idea where the condenser is especially greasy to disassemble, clean the whole condenser with carbon-tet, oil lightly, and reassemble).

**Corroded connections on coil, condenser, or tube sockets:** Wipe off the corrosion and go over the connections with a hot iron.

**Open coils:** Leads will generally be found broken near the terminal. Solder flexible leads, taking care that wire will not break beyond soldered joint.

**Poor contact in grid caps,** especially the ones that are held together with a rivet: The best way is to replace the cap, although it may be possible in some cases to solder the parts together.

**Leaky, shorted and open by-pass condensers** (avc, screen, cathode, etc.): Replace them.

**Noisy and open resistors:** Check for noise with pair of headphones and battery. Replace if noisy or if value has changed considerably.

**A.F.—Condensers and resistors:** Check for noise, opens and shorts and replace wherever necessary.

**Noisy and open transformers:** Check for noise with headphones; if bad, replace or change to resistance coupling.

**Noisy volume controls:** Some of the wire-wound types may be disassembled, cleaned with carbon-tet, and reassembled; some of the carbon types can be treated similarly, others will have to be replaced.

**POWER SUPPLIES—Open chokes:** Opens may sometimes be found at end of winding and repaired; but if they are located in the winding they must be replaced. A wire-wound resistor of equal D.C. resistance might be substituted if hum won't be too objectionable.

**Condensers and resistors:** Check for opens, leaks and shorts, and replace defective units. It is a good idea to use an auto-transformer and run the set for an hour or so at slightly higher voltage than normal. Good units will stand the overload without any trouble; any unit that shows up as defective would be liable to go bad during use and should be replaced.

**MISCELLANEOUS—Field coils** should be checked the same as chokes. Wiring should be checked for leakage and corroded connections should be cleaned and resoldered. Antenna and ground connections should, of course, be checked and the antenna itself should be looked over carefully for poor connections.

Here are also some general suggestions offered with a view to wartime conservation of materials:

In these days when vital materials are

scarce, every effort should be made to use as few new parts as possible. This does not mean that only used parts should be used in replacements, but that careful reasoning should be indulged in plus a check-up of what is on hand before purchasing new parts. For example, let us start with resistors.

Some sets use R.F. filters as in Fig. 1. The condenser shorts and burns out the resistor. Most servicemen will replace both. Generally, removing both and shorting the resistor terminals will put the set in operation. Of course, if the voltage is very much higher than usual, or if the set breaks into oscillation, the filter will have to be used. But this is not often the case.

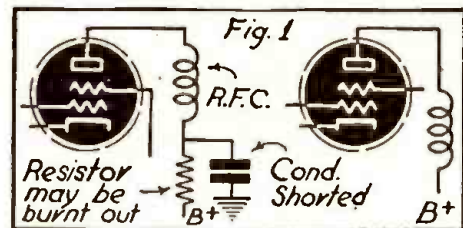

Another thing about resistors—it is seldom necessary to use the same value as the one to be replaced. The cathode resistor for a variable- $\mu$  tube often may be twice as high as its rated value without cutting the amplification seriously. However, other factors help determine the amplification, so there can be no hard and fast rule. On the other hand, resistors in a voltage-divider circuit carrying large amounts of current should be approximately the same as the original. And, of course, resistors in direct-coupled amplifiers and some phase inverters should run very close to the original values. Series resistors for screen-grid and plate supplies may be varied as much as 25 per cent, although as a rule a screen resistor should generally be higher rather than lower to avoid too high values of screen voltage.

Condenser values, generally speaking, are more critical than resistor values. The capacity of filter condensers in A.C. sets seldom can be reduced without raising the hum level. Occasionally a 4 mf. condenser can be substituted for an 8 mf. with little change. The same applies to A.C.-D.C. sets.

The author, an Erie County (N. Y.) Serviceman, has had considerable experience in repairing old sets for farm folk. Obtaining replacement parts frequently would mean long waiting periods and miles of travel. Since the compensation seldom warranted these double trips, Mr. Bixby had to devise the simplest possible means of putting these old sets in working order. His advice should prove useful to Servicemen now faced with wartime shortage of parts.

However, the capacity can be reduced considerably in sets that are used on D.C. only.

The value of coupling condenser in the audio portion of a receiver is seldom critical, and values from .02 mf. to .1 mf. make comparatively little change in the output. Better bass response, as a rule, will be obtained with the larger values. The values of cathode bypass in the power stage can be lowered sometimes to about 8 mf. without noticeably affecting the output.

Filter chokes generally will be replaced by similar ones. Field coils may have less resistance than the original if the first section of the bleeder has additional resistance added. Sometimes even that is unnecessary, and any changes made from, for example, 1500 ohms to 1250 ohms, or vice versa, may be made without any other changes. Quite often a break in field coils may be found and the coil repaired, thus making replacement unnecessary.

When the primary of a push-pull input transformer burns out and a reasonably good replacement is not available, tone quality nearly as good as the original can be had by using a resistor in the plate with a coupling condenser to one of the push-pull grids, as in figure 2. It is not claimed that the voltage on the grids will be equal, but for practical purposes it is difficult to tell the difference.

Some manufacturers took great pains to assure the serviceman that only a replacement part of their manufacture could be used in their set. This may be true to some extent as regards to R.F. transformers where the coils must match a certain tuning condenser, but virtually every other part can be interchanged with a similar part of different manufacture. Certainly a thousand-ohm one-watt resistor is the same whether A, B, or C makes it. One may have a larger safety factor than another—otherwise they are the same. The same applies to fixed condensers. I.F. transformers have different gain ratios and care should be taken for that reason in using other makes. Oscillation or lower volume than normal may result if the gain is not approximately the same.

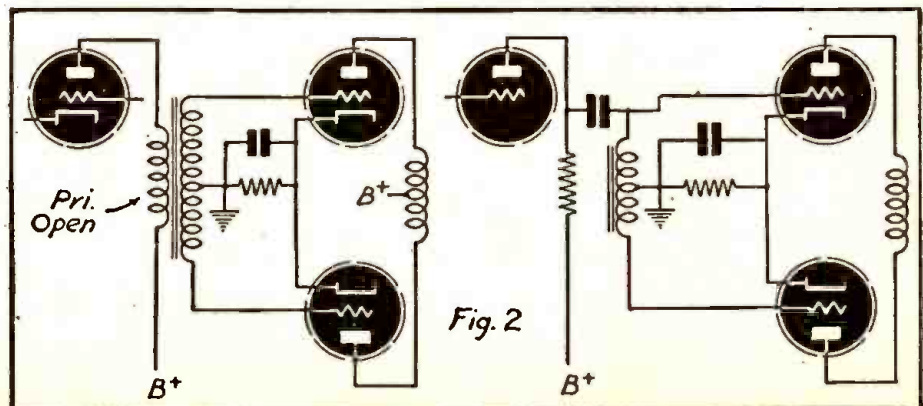

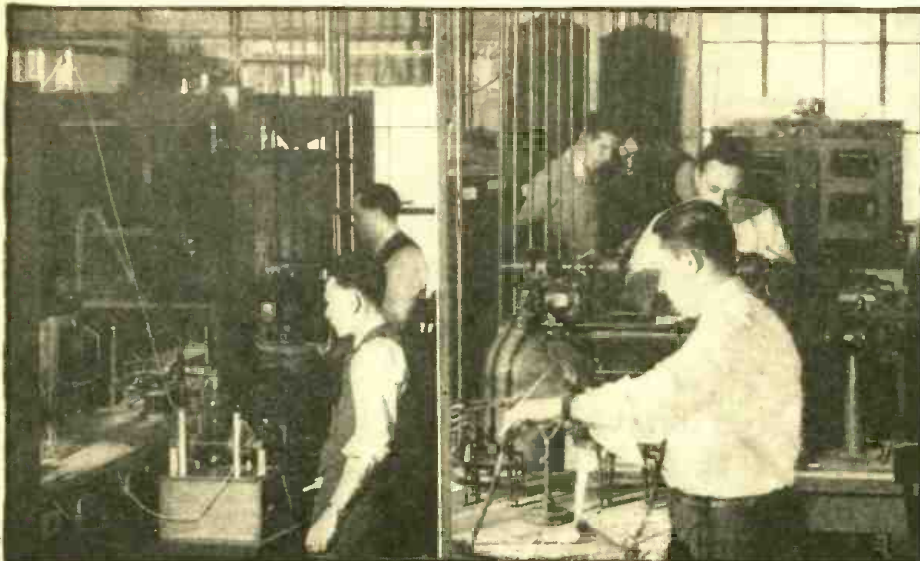

Two sections of experimental laboratories at the Signal Corps' Radar Division.

*In response to numerous inquiries from readers eager to offer their services to the U. S. Government, Radio-Craft is pleased to publish full information regarding positions open to Radio Servicemen as well as to laboratory and administrative workers.*

# RADAR LABORATORY NEEDS SERVICEMEN

**T**HE Signal Corps Radar Laboratory, Camp Evans, Belmar, New Jersey, has a large number of vacancies in Civil Service positions for men and women to work on secret Signal Corps equipment. In addition to very many opportunities for Engineers, Physicists, and Electricians, there is an especially urgent need for Radio Mechanics.

Licensed amateurs or persons who have completed a defense course in Radio are desired for appointment as Junior Engineering Aides (Radio), at \$1440 per annum. Qualified radio servicemen may be eligible for appointment at \$1800, \$2000 and up, in accordance with the length and quality of their experience.

Persons who desire to participate in the National Victory Program by accepting appointment at Camp Evans should write to the Special Representative, U. S. Civil Service Commission, Radar Laboratory, Camp Evans, Belmar, New Jersey.

## LOCATION

The headquarters of the Laboratory is at Camp Evans, Belmar, N. J. Installation and maintenance work is done wherever Radars are needed by the Army.

The Laboratory is located on the shore of the Shark River, 2 miles from the town of Belmar and 4 miles from the famous seaside resort of Asbury Park. Belmar is about 60 miles south of New York City, 1½ hours by convenient commuting trains.

The Laboratory now occupies several buildings which the Army purchased.

The work is administered and supervised by a group of commissioned officers of the United States Army. The remainder of the personnel consists entirely of Civil Service employees. There are no enlisted men in the Laboratory.

The civilian personnel includes the highest type of professional and semi-professional employees carefully selected and hired under Civil Service regulations.

Office hours are from 8:00 A.M. to 4:30 P.M., Monday through Saturday. A skeleton staff is maintained on Sundays and holidays.

The nearby cities of Red Bank, Long Branch, Asbury Park and Belmar offer many opportunities for rentals. Since with the large growth of the Laboratory (particularly in the summer season, when the resort demands are heavy), accommodations may be scarce, the Government is planning a large housing project within walking distance of the Laboratory.

## PLACES TO LIVE

A list of possible rentals is on file at the Laboratory to help those searching for a place to live. All the nearby cities and towns are well provided with good elementary and high schools and churches of all denominations. Monmouth Junior College is in Long Branch and Rutgers University is about 40 miles away in the city of New Brunswick.

The neighboring resort towns offer the finest ocean beaches for summer recreation. In addition, the entertainment and recreation features are available along the boardwalk. New York City is near enough so that it is possible to go to the theater in Times Square and get home the same evening. The cities of Long Branch, Asbury Park, and Belmar are connected with the Laboratory by convenient bus lines. There are also bus lines between the cities and to and from the beaches.

## OPPORTUNITIES FOR TRAVEL

All civilian employees of the United States Government may be required to travel anywhere, as their duties require. However, civilian employees are not sent into combat zones without their consent. For the installation and maintenance of Radars some employees will travel to any part of the world where war operations are going on or may take place.

Employees who travel are furnished transportation plus an extra per diem payment of \$6 in the United States and \$7 outside.

## MILITARY STATUS

Employees of the War Department enjoy the same status as civilian employees of

other Government departments. They are not in the Army and are not subject to military law. Through the development and production contracts which the Laboratory has made with many of the large industrial concerns of the United States, there will be opportunities to meet representatives of these industries.

Exemption from the draft depends upon your classification. The Laboratory can be sure of keeping only those who are already exempt, or who have proved themselves indispensable to the work of the Laboratory.

Regardless of your classification you must always notify your Draft Board before you travel. If your classification is 3A, that is, if your local board has granted deferment because of dependents, then it will not affect your coming to duty with the Laboratory. If your classification is 1A, you should obtain permission from your local Draft Board and state that you are going to be employed with an agency which is a vital part of the war program.

## EMPLOYMENT OF WOMEN

Because of the Army's demand on the men of the nation, the Laboratory expects to use women for many operations formerly performed mostly by men; for instance, the Laboratory would welcome women employees who can function as mathematicians, physicists, radio engineers, mechanics, testers, and draftsmen, as well as in the more usual ways as administrative employees.

Because of the vital importance of the work of the Laboratory in the supreme national effort to win the war, the Laboratory does not look with favor upon requests for resignation or transfer. While it is true that soldiers fight the war, they cannot fight without equipment. It is the function of the Laboratory to provide some of this equipment and any delay in operations caused by personnel changes means a delay in delivering essential fighting tools to the troops.



# Make a Fluorescent Display From Old Radio Parts

*The Serviceman who is eager to improve the appearance of his shop or the Experimenter who wants to enhance the lighting in his home can duplicate the display fixture described by using octal sockets, a line-cord resistor and some wire.*

HAROLD DAVIS

**F**LUORESCENT LIGHTING is becoming one of the "musts" of any modern and well-equipped business.

The advantages of this relatively new form of illumination for either ordinary lighting or for display purposes are too well known to be enumerated here. Suffice it to say that fluorescent lighting is definitely better—physically, economically and practically.

The development of the fluorescent tube was the first real improvement in lighting since Thomas Edison gave the world the electric light, and, in the opinion of the writer, had it come a generation or so sooner, many pieces of expensive optical glass would have been made instead into lowly window panes.

Possibly the only disadvantage of fluorescent lighting is the high initial cost. If one can stand this first cost, the investment will take care of itself. However, there are always ways and means, and, as with all other things, a little first-hand knowledge of the subject will enable the clipping of a corner or two. In fact, expert knowledge of how a fluorescent light works will enable any radio man to reach into his junk box and come up with a fluorescent fixture.

## PRINCIPLES OF OPERATION

While much has been written on the subject, it is likely that a review of the fundamental of the fluorescent circuit will be helpful. It consists of three basic parts: the lamp, which contains an individual filament in each end; a ballast to limit the current flow; and a starter to pre-heat the filaments so that they emit an abundance of electrons to strike the arc. All these parts are directly in series (Fig. 1). When the current is applied there is no drain and the full line voltage is applied across the starter. This is a small glass bulb containing an inert gas and a bi-metal strip. The line voltage arcs across the gap, heating the strip which expands and touches the other electrode, closing the entire series circuit. Current now flows through the ballast, both filaments and across the starter, which is now a closed switch. When the filaments are heated they start emitting electrons, and in less time than it takes to tell it, the bi-metal strip cools (because the arcing stops when the contact is made) and contracts to its former open position. This breaks the filament circuit, which in turn applies the full voltage to each end of the fluorescent tube. As the filaments have been heated and have released electrons, these electrons now rush to the charged electrodes and the arc is struck. Of course, the heating of the filaments also heats the mercury in the tube, vaporizing it and affording a low-resistance path for the electron flow.

The current path is now through the ballast up to each filament and through the tube (Fig. 2). There still is a potential applied across the starter, but this potential is now approximately half what it was because of the voltage drop across the ballast when the arc was struck. The characteristics of the starter are such that the reduced voltage will not arc the gap. As a result the starter remains idle until the full line voltage is again applied, which occurs when the arc ceases.

## WHY A BALLAST IS NECESSARY

Now the reason for the ballast is simply this: A mercury arc must have a current-limiting device in series with it. The arc, being of negative resistance, would draw from its power source enough current to melt the electrodes if a positive resistance were not used. Consequently there must be sufficient resistance in the circuit to limit the current flow to a safe value.

Inductive ballasts are preferred because the inductive loss is not so great as a pure resistive loss and also because the surge developed when the starter opens the filament circuit helps to strike the arc. In addition, an inductive device opposes voltage changes and has a tendency to decrease the stroboscopic effect (rapid flickering) caused by the cyclic rise and fall of the A.C. voltage.

## RESISTOR BALLAST IS SUITABLE

Although commercial fixtures use inductive ballasts, this does not mean that inductive ballasts are essential. Resistive ballasts work surprisingly well, and since resistors are items that the radio serviceman has access to, these are favored in this article.

Resistive ballasts can be used only on lamps of 24 inches (20 watts) and smaller, unless a higher line voltage (220) is available. All our experiments were made with the smaller tubes on a 117-volt line.

The first experiments were undertaken

to eliminate the starter, or to find a substitute for it. This was very simple. Two pieces of wire run from contacts 3 and 4 (in Fig. 3), touched together for a few seconds and then broken will light the tube as effectively as a manufactured starter. A single-pole switch is ideal, and we decided on using a small pearl push-button of the door-bell variety. The manufactured starters have a small condenser (.006 mf.) across them to assist in striking the arc. We found that instead of placing this condenser across the switch points we could place it as shown in Fig. 3 and get better results. Connecting the condenser from one side of the line to the body of the fixture lowers the static charge and this has quite a bit to do with the amount of voltage necessary to strike the arc.

## LINE CORD RESISTOR FOR BALLAST

Finding a suitable resistive ballast was not so easy as finding a starter, and everything from Red Devils to light bulbs were tried. When we finally hit upon an A.C.-D.C. line cord we met with success. Connections are shown in Fig. 3. One wire is not used in a single-lamp setup. The cord must be 150 ohms for 20-watt tubes and 210 ohms for 15 watts. For 15-watt tubes we used the T-12 or large (1½") type. The static charge on the larger type is less and these are more easily started. Some difficulty was experienced in starting the

(Continued on page 691)

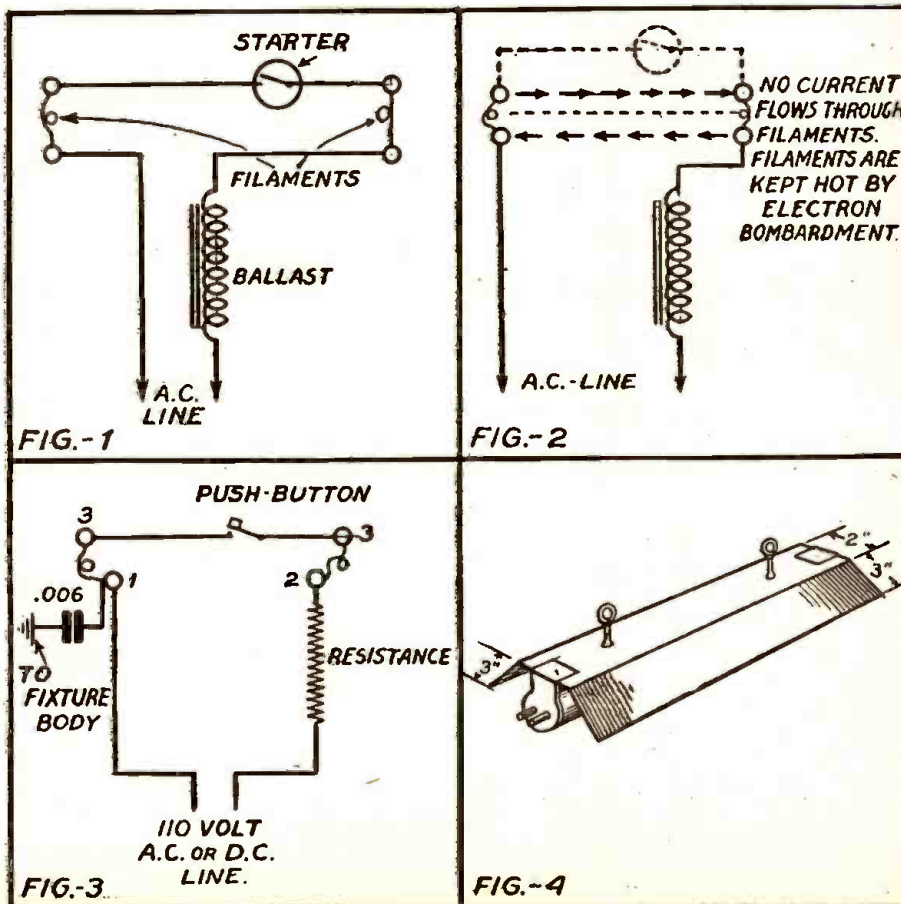

# THE LATEST!

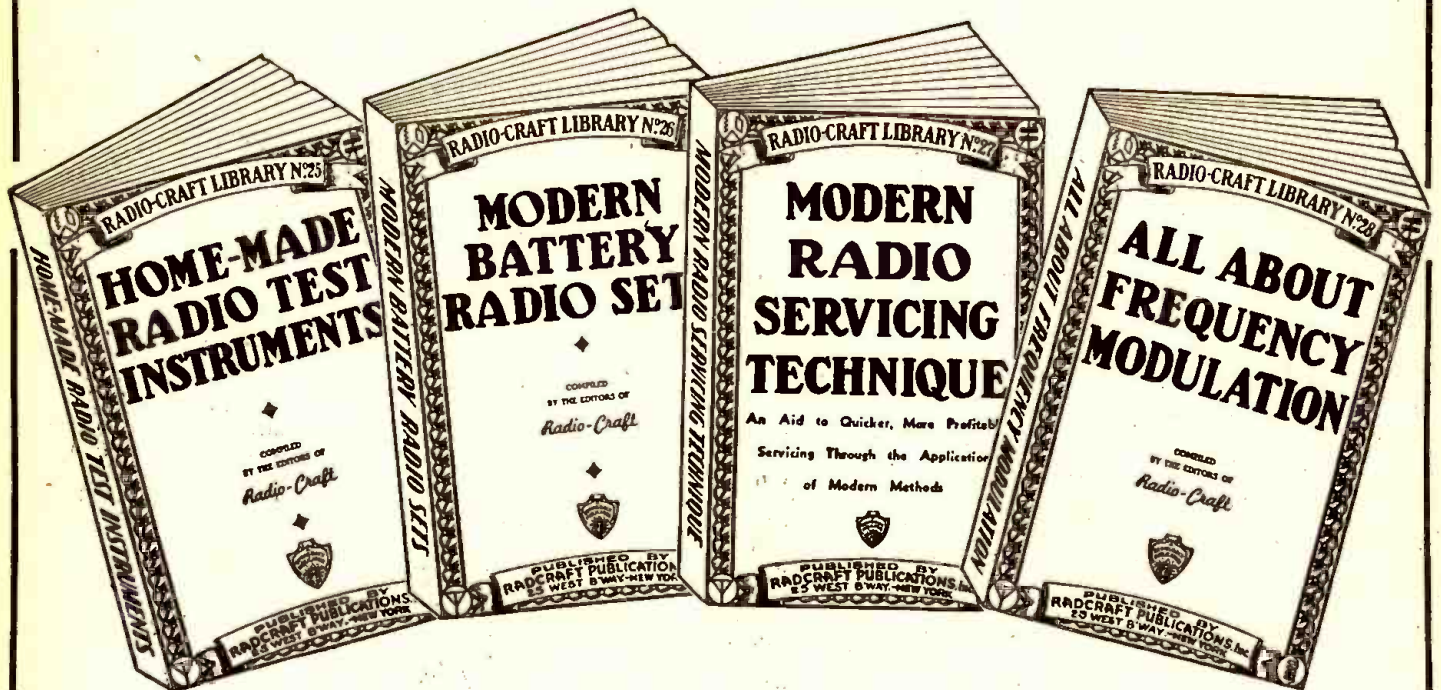

## New RADIO-CRAFT Library Books

**T**HE four latest books of our well-known RADIO-CRAFT Red Books—Nos. 25, 26, 27 and 28—have just come off the press. These four books are all on timely subjects and we recommend every one of them to you strongly.

Now, more than ever, radio education has become a burning question. If you are to be in the National Service; in the Army, Navy or Air Force—practical radio knowledge is of paramount importance. **YOU CAN GET BETTER RATINGS AND ADVANCE QUICKER IF YOU HAVE A GOOD RADIO BACKGROUND.**

Conversely, if you are not with the armed forces, there is a whole of a job to be done at home. With more and more men going into the service, the demand for practical servicemen becomes greater each day. Therefore we say: **PROFIT BY THESE UNIQUE BOOKS, WHICH ARE PRICED SO LOW THAT THEY ARE WITHIN THE REACH OF EVERYONE'S PURSE.**

### No. 25—HOME-MADE RADIO TEST INSTRUMENTS

This book includes articles covering a wide range of test apparatus of live interest to every radio man. Servicemen will find many circuits in this book to make their work more profitable. New ideas in test equipment make it possible to service radio receivers more quickly.

Laboratory workers and experimenters will find many articles which describe in detail construction and use of all essential radio test units—multi-meters, oscillators, stage-analysis testers, oscilloscope equipment, V.-T. voltmeters, etc. Even advanced technicians will be interested in the circuit arrangements showing the new and improved variations of well-known, basic test equipment. A MUST for every serviceman. This book contains 86 illustrations.

**Outline of Contents:** A Low-Cost Signal Chaser—Signal Tracer Test Unit—Simplified Practical Signal Tracer—A Home-Made Infinite-Resistance Tube Checker—Build This Direct-Reading V.-T. Voltmeter—How to Make a Modern V.-T. Voltmeter—Measuring High Values of A.C. Voltage and Current With a Low-Range Meter—How to Make a Meter-Range Extender—How to Build a Practical Tube Tester and Set-Analyzer Adapter—The Beginner's Simple Volt-Milliammeter—Build This Simplified Neon-Type Test Unit—Midget Oscilloscope—How to Make and Use a Frequency Wobbler—Double Tracing Your Oscilloscope—Home-Made Frequency Modulator.

### No. 26—MODERN BATTERY RADIO SETS

Whether you are a radio man or a beginner, the articles in this book give you basic circuit arrangements or elementary radio receivers which serve the dual role of teaching the elements of radio reception, as well as making perfectly-operating 1- and 2-tube radio receivers. Picture diagrams and bread-board layouts galore.

Advanced radio set builders are offered more complicated arrangements. Laboratory workers and engineers will find in many of the articles circuit and constructional features which have become commercial practice. Many entirely new ideas are given in this book. One of the most important volumes we recently issued. This book contains 76 illustrations.

**Outline of Contents:** Beginner's 1-Tube High-Gain All-Wave Receiver—Beginners-Build This 1-Tube Loop Receiver—A "3-in-1" Battery Portable—An Easily-Built "Fluorescing Superregenerative" 2-In-1 "Card File" Battery Set—A 2-Tube Superhet. With Pentagrid Regenerative 2nd-Detector—The 4-Tube Superhet. Vacation Portable—The "Lunchbox 5" Battery Portable—The "Seafarer" Loop-Type Boat Radio Set—4-Tube Portability Portable—An All-Purpose Portable—A Typical Commercial 3-Way Portable (Pilot Models X-1452 and X-1453)—Switch for Varying "C" Bias on Battery Radio Sets—Making a Simple Portable Aerial—Making a Pilot-Light Fuse—Old Auto Sets for New Cars—Using a Loop Portable in Cars—Quasi-Electric Soldering Iron—Lamp Bulbs as Resistors.

### No. 27—MODERN RADIO SERVICING TECHNIQUE

Here is a book of great importance to every radio man, every radio engineer, and particularly all radio servicemen. A list of the contents which follows shows the importance of this book, literally jam-packed to overflowing with radio meat. Whether you are a servicing beginner or whether you are an experienced serviceman—you will find many important hints in this volume.

Book is eminently practical and will solve many problems for you. More important: It will show you many short-cuts, all calculated to save your time and patience. Practical everyday data on standard receivers appears throughout the book. A whole of a book compressed into a minimum of space. Contains 98 important illustrations.

**Outline of Contents:** Elementary Servicing Technique—Correct Procedure for the Servicing Beginner—Elementary Procedure for Servicing Radio Sets—A.F.C. Alignment Made Easy—Dynamic Servicing—Dynamic Testing Simplifies Servicing—Modern Receiver Test Requirements—Servicing Universal A.C.-D.C. Receivers—Servicing "Orphans" and Private-Brand Sets—Emergency Servicing Without Test Meters—Servicing Coils—Servicing R.F. Coils—Servicing Oscillator Coils—General Information—RMA Transformer Color Code—What Causes Echo, Fading?—Radio Service Puzzlers.

### No. 28—ALL ABOUT FREQUENCY MODULATION

Here is a complete compilation of pertinent data on the entire subject of the new coming art of Frequency Modulation.

There is no question but that Frequency Modulation is already revolutionizing radio broadcasting in this country. Were it not for the war, there would now be a tremendous boom in this new art—yet, even with war restrictions imposed upon it, Frequency Modulation is still jumping ahead by leaps and bounds.

With Frequency Modulation no longer a theory—with hundreds of stations already dotting the land and with countless hundreds of others to come when peace is achieved once more—every radio man should read up and know all there is to know on this most important subject.

This particular handbook is check-full with a tremendous amount of information which you probably will not find in any similar book in print.

**Outline of Contents:** The ABC of F.M.—Frequency vs. Amplitude Modulation—Basic Facts About F.M. Broadcasting—Construction—Build This Practical F.M. Adapter—Audio Amplification—F.M. Audio Amplifier, Part 1—F.M. Audio Amplifier, Part 2—F.M. Audio Amplifier, Part 3—F.M. Service—Part 1. Antenna Installation and Service—Part 2. Receiver Alignment and Diagnosis—Part 3. Test Equipment for F.M. Servicing. Engineering—Part 1. The How and Why of F.M.—Part 2. The How and Why of F.M.—Theory and Design Considerations of R.F. and I.F. Coils in F.M. Receivers.

### SPECIAL SEND-NO-MONEY OFFER

It is not necessary that you send money with order. If you wish to take advantage of our C.O.D. plan, simply cut out the coupon, paste it on a post card and send it to us. Books will be sent to you immediately.

All four books are listed uniformly at 50c each. No discount on less than three books.

If you wish to take advantage of our special offer, ordering three books or more, we make an unusual low price to you as follows:

3 books—\$1.25  
4 books—\$1.50

Do not fail to send coupon today!

**RADIO-CRAFT PUBLICATIONS, INC.**  
25 West Broadway, New York, N. Y.

Radio-Craft Publications, Inc.		742
25 West Broadway, New York, N. Y.		
Gentlemen:		
Rush to me by return mail, as per your special offer, the following books: (Check books selected.)		
<input type="checkbox"/>	No. 25—HOME-MADE RADIO TEST INSTRUMENTS.	
<input type="checkbox"/>	No. 26—MODERN BATTERY RADIO SETS.	
<input type="checkbox"/>	No. 27—MODERN RADIO SERVICING TECHNIQUE.	
<input type="checkbox"/>	No. 28—ALL ABOUT FREQUENCY MODULATION.	
I will pay postman \$1.00 (if two books are ordered) plus a few cents postage and charges, \$1.25 for three books, plus a few cents postage and charges, \$1.50 for four books, plus a few cents postage and charges. <b>WE CANNOT SEND A SINGLE 50c BOOK C.O.D.</b>		
NAME .....		
ADDRESS .....		
CITY ..... STATE .....		
<input type="checkbox"/> Save shipping and C.O.D. charges! Check here if you send cash with order. (Cash, U.S. new postage stamps, money order, check.) Foreign countries no C.O.D. Add 20% to all prices quoted.		

## How WPB Tube Curbs May Affect Serviceman

THE recent War Production Board order discontinuing the manufacture of certain types of receiving tubes, except for war production orders, does not seriously affect the Serviceman.

Of the 349 receiving tube types discontinued by the W.P.B. order, only 80 types currently listed by RCA are affected. In most cases the Serviceman will be able to use one tube where three tubes of similar

or nearly similar characteristics were previously available.

The table shown on this page lists these 80 types and includes also 60 additional (Continued on page 691)

Tube Type Discontinued	RCA REPLACEMENT		Key No.	Tube Type Discontinued	RCA REPLACEMENT		Key No.
	Direct	Possible*			Direct	Possible*	
1A5-G	1A5-GT/G	—		6A7S	—	6A7	(3)
1A5-GT	1A5-GT/G	—		6AB5	6AB5/6N5	—	
1A7-G	—	1A7-GT	(4)	6AB6-G	—	6K6-GT/G	(4)
1B4-P	—	1A4-P	(4)	6AB7	6AB7/1853	—	
1B5	1B5/25S	—		6AC5-G	6AC5-GT/G	—	
1C5-G	1C5-GT/G	—		6AC5-GT	6AC5-GT/G	—	
1C5-GT	1C5-GT/G	—		6AC7	6AC7/1852	—	
1D7-G	—	1A6	(2)	6AD6-G	—	6AF6-G	(4)
1E5-GP	—	1A4-P	(4)	6AE5-G	6AE5-GT/G	—	
1E7-G	—	2-1F5-G	(4)	6AE5-GT	6AE5-GT/G	—	
1F7-GH	1F7-G	—		6AE6-G	—	—	
1F7-GV	1F7-G	—		6AE7-GT	—	6SN7-GT	(4)
1G4-G	1G4-GT/G	—		6B7-S	—	6B7	(3)
1G4-GT	1G4-GT/G	—		6C5-G	6C5-GT/G	—	
1G6-G	1G6-GT/G	—		6C5-GT	6C5-GT/G	—	
1G6-GT	1G6-GT/G	—		6C7	—	6R7-G	(4)
1H5-G	—	1H5-GT	(4)	6D7	—	6C6	(2)
1J5-G	—	1G5-G	(4)	6E6	—	—	
1N5-G	—	1N5-GT	(4)	6E7	—	6D6	(2)
1N6-G	—	—		6G5	6U5/6G5	—	
1Q5-G	1Q5-GT/G	—		6H6-G	6H6-GT/G	—	
1Q5-GT	1Q5-GT/G	—		6H6-GT	6H6-GT/G	—	
2B7	—	—		6J5-G	6J5-GT/G	—	
2E5	—	—		6J5-GT	6J5-GT/G	—	
3Q5-G	3Q5-GT/G	—		6K6-G	6K6-GT/G	—	
3Q5-GT	3Q5-GT/G	—		6K6-GT	6K6-GT/G	—	
		5X4-G	(4)	6N5	6AB5/6N5	—	
5T4	—	5U4-G	(4)	6N7-G	6N7	—	
		—		6N7-GT/G	6N7-GT/G	—	
5W4	5W4-GT/G	—		6N7	6N7-GT/G	—	
5W4-G	5W4-GT/G	—		6N7GT	—	—	
5W4-GT	5W4-GT/G	—		6P5-G	6P5-GT/G	—	
5Y3-G	5Y3-GT/G	—		6P5-GT	6P5-GT/G	—	
5Y3-GT	5Y3-GT/G	—		6P7-G	—	6F7	(2)
6A4-LA	—	6K6-GT/G	(4)	25AC5-G	25AC5-GT/G	—	
6SA7-G	6SA7-GT/G	—		25AC5-GT	25AC5-GT/G	—	
6SA7-GT	6SA7-GT/G	—		25B5	—	25L6-GT/G	(4)
6SK7-GT	6SK7-GT/G	—		25B6-G	—	25L6-GT/G	(4)
6SQ7-G	6SQ7-GT/G	—		25B8-GT	—	—	
6SQ7-GT	6SQ7-GT/G	—		25L6	25L6-GT/G	—	
6T7-G/6Q6-G	6T7-G	—		25L6-G	25L6-GT/G	—	
6U5	6U5/6G5	—		25L6-GT	25L6-GT/G	—	
6V6-G	6V6-GT/G	—		25N6-G	—	25L6-GT/G	(4)
6V6-GT	6V6-GT/G	—		25S	1B5/25S	—	
6V7-G	—	85	(2)	25Y5	—	25Z6-GT/G	(4)
6X5	6X5-GT/G	—		25Z6-G	25Z6-GT/G	—	
6X5-G	6X5-GT/G	—		25Z6-GT	25Z6-GT/G	—	
6X5-GT	6X5-GT/G	—		31	—	1G5-G	(4)
6Y5	—	6X5-GT/G	(1)	35A5-LT	35A5	—	
6Y7-G	—	6N7-GT/G	(4)	35L6-G	35L6-GT/G	—	
6Z4	84/6Z4	—		35L6-GT	35L6-GT/G	—	
6Z5	—	6X5-GT/G	(1)	35Z3-LT	35Z3	—	
		6N7-GT/6	(4)	35Z5-G	35Z5-GT/G	—	
6Z7-G	—	6SC7	(4)	35Z5-GT	35Z5-GT/G	—	
		6SL7-GT	(4)	48	—	—	
7A7-LM	7A7	—		49	—	1J6-G	(4)
7B5-LT	7B5	—		50Y6-G	50Y6-GT/G	—	
7B6-LM	7B6	—		50Y6-GT	50Y6-GT/G	—	
7B8-LM	7B8	—		50Z7-G	—	50Y6-GT/G	(4)
7C5-LT	7C5	—		55	—	—	
7G7	7G7/1232	—		79	—	6N7-GT/G	(4)
12A5	—	6K6-GT/G	(4)	84	84/6Z4	—	
12B7	14A7/12B7	—		89	—	—	
12SA7-G	12SA7-GT/G	—		117L7-GT	117L7/M7-GT	—	
12SA7-GT	12SA7-GT/G	—		117M7-GT	117L7/M7-GT	—	
12SK7-GT	12SK7-GT/G	—		117Z6-G	117Z6-GT/G	—	
12SQ7-GT	12SQ7-GT/G	—		117Z6-GT	117Z6-GT/G	—	
14A7	14A7/12B7	—		183/483	—	45	(4)
15	—	—		485	—	27	(4)
25A6	25A6-GT/G	—		1232	7G7/1232	—	
25A6-G	25A6-GT/G	—		1852	6AC7/1852	—	
25A6-GT	25A6-GT/G	—		1853	6AB7/1853	—	
25A7-G	25A7-GT/G	—					
25A7-GT	25A7-GT/G	—					

\*Indicates that the types in this column may be used as replacements for the RCA types discontinued by making the changes as indicated by the key numbers. 1. Requires wiring change. 2. Requires socket change. 3. May require shielding. 4. May require components or adjustments, additional to those of 1, 2, or 3. Note: When tube types other than audio or rectifier types are replaced, realignment of the receiver is recommended.

LAFAYETTE FE 250 SERIES 12-TUBE, 5-BAND A.C. RECEIVERS

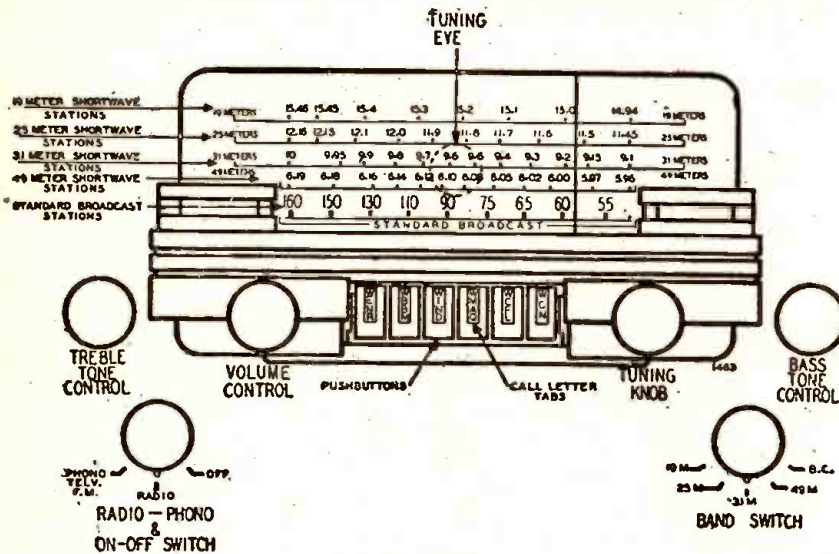

RESETTING THE PUSHBUTTONS

Pull one of the pushbuttons all the way out as far as it will come. Tune in the station you want and turn the tuning knob back and forth until the station is clear and distinct, using the tuning eye as an indicator. Now push the button *hard* all the way in to lock the station in place (push directly on front of button). Continue setting each pushbutton in the same way. If pressing the proper button does not tune the station selected you did not push the button hard enough to lock it in place when setting up the station.

ALIGNING INSTRUCTIONS

**CAUTION:** No aligning adjustments should be attempted without first thoroughly checking over all other possible causes of trouble, such as poor installations, open or grounded antenna systems, low line voltage, defective tubes, condensers and resistors. In order properly to align this radio, the chassis should be removed from the cabinet. Although the short-wave bands on this radio are of the band-spread type the alignment procedure is not difficult. However, because each short-wave scale covers only a small portion of the short-wave spectrum you must do the work carefully and your oscillator must be accurate.

Do not re-align the band-spread scales unless you are positive they are out of adjustment. When adjustment is necessary proceed as follows.

Tune set to the high frequency end of dial scale on any band.

Rotate each iron core until the fine score marks are even with the edge of the coil forms.

You are now ready to continue with the trimmer adjustments as shown on the alignment chart.

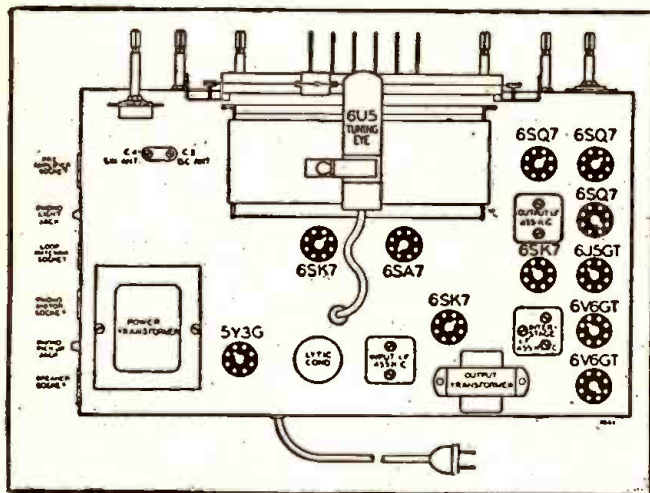

Dial scale and chassis views of the Lafayette FE 250 Series chassis which is housed in different styles of cabinets. Provision is made in this receiver for connecting an F-M tuner.

CHASSIS VIEW

ALIGNMENT PROCEDURE

- Tone control—Treble.
- Volume control—Maximum all adjustments.
- Use an all-wave signal generator which will provide an accurately calibrated signal at the test frequencies listed.

BAND	SIGNAL GENERATOR Frequency Setting	Dummy Antenna	Connection to Radio	Position of Band Switch	Dial Pointer Setting	Trimmers Adjusted to Maximum
I. F.	465 Kc.	.1 MFD.	Grid of 6SK7 (I.F.)	Broadcast	Set Dial at 1600 Kc.	On Top of Output I.F.
	455 Kc.	.1 MFD.	Grid of 6SA7	Broadcast	Set Dial at 1600 Kc.	On Top of Input I.F.
31 METER BAND	9.6 Mc.	400 ohms	Antenna lead	31M	Set Dial at 9.6 Mc.	(See Trimmer View) C21—Osc. (See Trimmer View) C12—R.F. (See Chassis View) C4—Ant.
49 METER BAND	6.1 Mc.	400 ohms	Antenna lead	49M	Set Dial at 6.1 Mc.	(See Trimmer View) T14—Osc. (See Trimmer View) T8—R.F. (See Trimmer View) T4—Ant.
25 METER BAND	11.8 Mc.	400 ohms	Antenna lead	25M	Set Dial at 11.8 Mc.	(See Trimmer View) T15—Osc. (See Trimmer View) T9—R.F. (See Trimmer View) T5—Ant.
19 METER BAND	15.2 Mc.	400 ohms	Antenna lead	19M	Set Dial at 15.2 Mc.	(See Trimmer View) T16—Osc. (See Trimmer View) T10—R.F. (See Trimmer View) T6—Ant.
BROAD-CAST BAND	1600 Kc.	200 mmf.	Antenna lead	Broadcast	Set Dial at 1600 Kc.	(See Trimmer View) C18—Osc. (See Trimmer View) C13—R.F. (See Chassis View) C3—Ant.
	1400 Kc.	200 mmf.	Antenna lead	Broadcast	Set Dial at 1400 Kc.	Rotate Core T11—R.F. Rotate Core T2—Ant. (See Iron Core Adjustment View)

# Radio Service Data Sheet

324

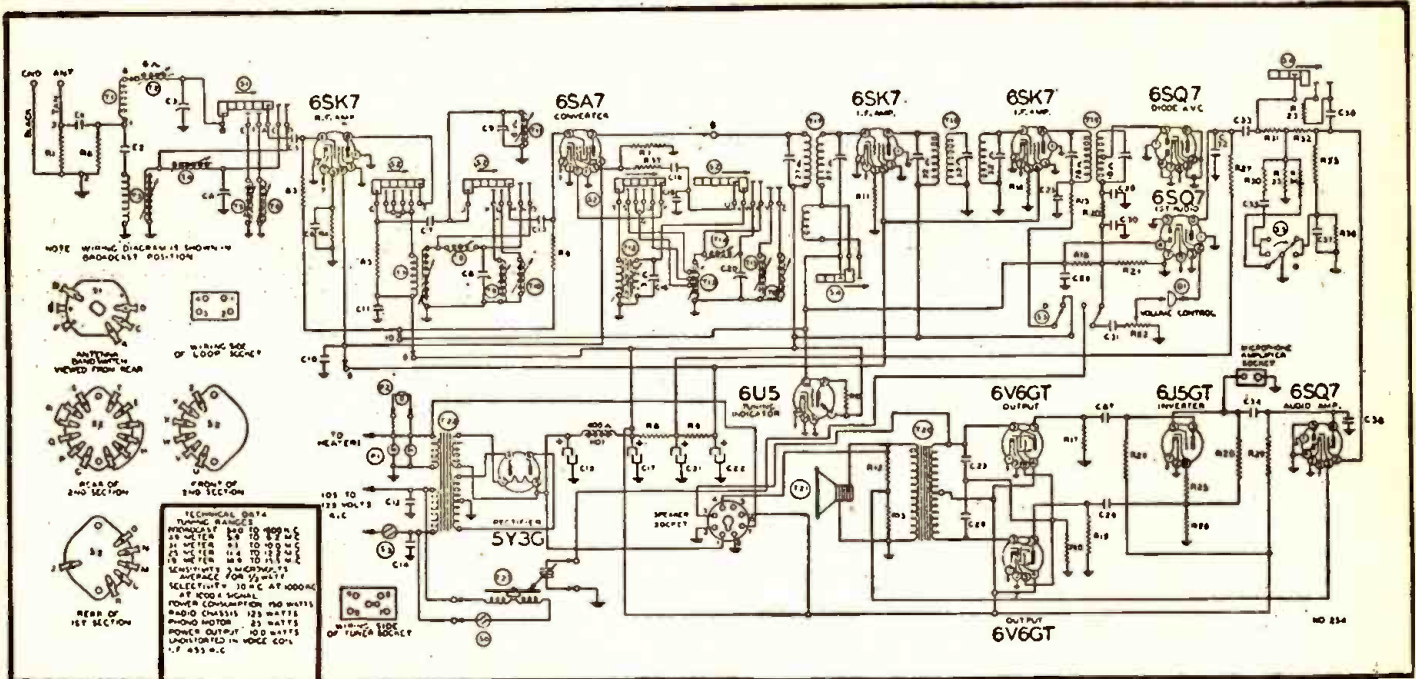

## PARTS LIST

- Resistors**  
 R1, R2, R30—25M Ohm, 1/3-Watt Resistor  
 R3, R6—1 Megohm, 1/3-Watt Resistor  
 R4—250 Ohm, 1/3-Watt Resistor  
 R5—5M Ohm, 1/3-Watt Resistor  
 R7—25M Ohm, 1/3-Watt Resistor  
 R8—6M Ohm, 2-Watt Resistor  
 R9—10M Ohm, 2-Watt Resistor  
 R10—1 Megohm, In Tuning Eye Cable  
 R11—500 Ohm, 1/3-Watt Resistor  
 R12—10M Ohm, 1/3-Watt Resistor  
 R13—1500 Ohms, 1/3-Watt Resistor  
 R14, R15—2M Ohm, 1/3-Watt Resistor  
 R16—1 Megohm, 1/3-Watt Resistor  
 R17, R19, R28—500M, 1/3-Watt Resistor  
 R18—250 Ohm, 2-Watt Resistor  
 R20, R24, R26—50M Ohm, 1/3-Watt Resistor  
 R21—120M Ohm, 1/3-Watt Resistor  
 R22—Volume Control (500M Ohms)  
 R23—1.5 Megohm, 1/3-Watt Resistor  
 R25—5M Ohm, 1/3-Watt Resistor  
 R27, R29—250M Ohm, 1/3-Watt Resistor  
 R31, R35—150M Ohm, 1/3-Watt Resistor  
 R32—350M Ohm, 1/3-Watt Resistor  
 R33—200M Ohm, 1/3-Watt Resistor  
 R34—75M Ohm, 1/3-Watt Resistor  
 R36—2 Megohm, 1/3-Watt Resistor  
 R37—50 Ohm, 1/3-Watt Resistor

- Condensers**  
 C1, C5—.0005 Mica  
 C2—.002 x 600-Volt Tubular Condenser  
 C3, C4—B.C. and 9 Mc. Dual Adjustable Antenna Trimmer  
 C6—.1 x 200-Volt Tubular  
 C7—.00001 Mica  
 C8—9 Mc., R.F. Adjustable Trimmer  
 C9—B.C., R.F. Adjustable Trimmer  
 C10, C11—.1 x 400-Volt Tubular  
 C12, C14—.02 x 600-Volt Bakelite  
 C13—.0005 Mica  
 C15, C17, C21—Electrolytic Filter Condenser  
 30 Mf.; 30 Mf.; 10 Mf. x 450 Volts  
 C16—B.C. Oscillator Adjustable Trimmer Condenser  
 C18—.0002 Silver Mica  
 C19—.00005 Mica  
 C20—9 Mc. Oscillator Adjustable Trimmer  
 C22—Electrolytic Filter 16 Mfd. x 350 Volts  
 C23, C24—.015 x 600-Volt Tubular  
 C25, C33—.1 x 400-Volt Tubular  
 C26, C31—.1 x 200-Volt Tubular  
 C27, C34—.05 x 400-Volt Tubular  
 C28—.05 x 200-Volt Tubular  
 C29, C30—.0001 Mica  
 C32, C38—.00025 Mica  
 C35—.008 x 600-Volt Tubular  
 C36—.00009 Mica  
 C37—.003 x 600 Volt Tubular

- Miscellaneous**  
 S5—Base Tone Switch—Three Positions  
 S4—Treble Tone Switch—Three Positions  
 S3—Phono-On-Off Switch  
 B1—Bias Cell, 1.25 Volt Potential  
 P1—6-8 Volt Pilot Light Bulb, Type T-44  
 P2—6-8 Volt Indicator Light T-44  
 T1—Loop Antenna Assembly.

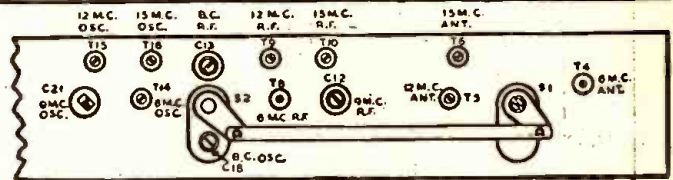

Trimmer View.

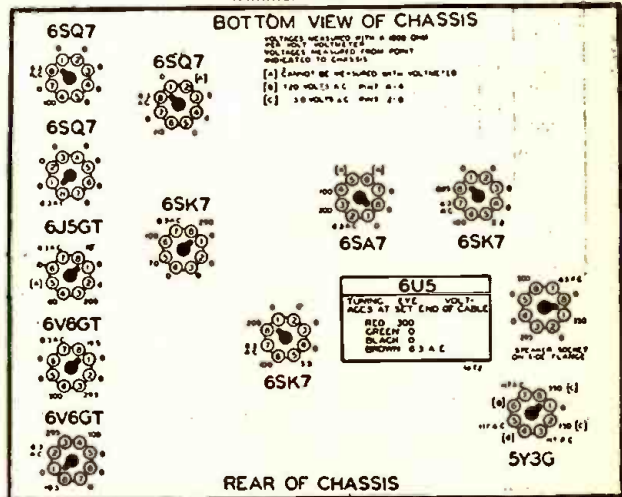

BOTTOM VIEW OF CHASSIS

REAR OF CHASSIS

Volume Chart

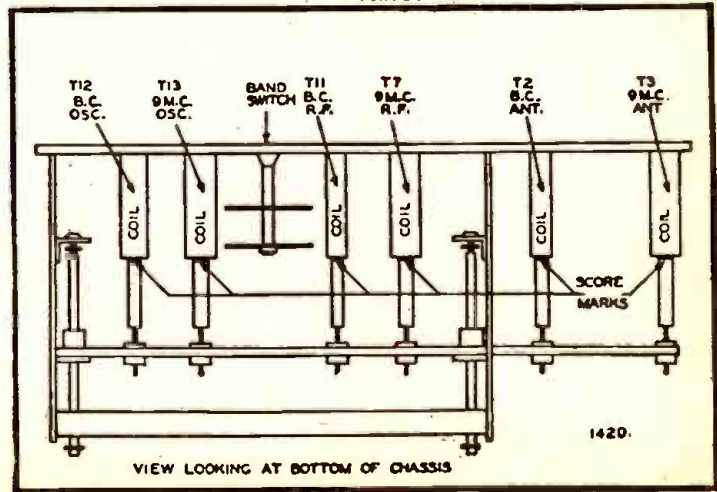

VIEW LOOKING AT BOTTOM OF CHASSIS

Iron Core Adjustment View.

**2** Handy Aids  
for Resistance  
Problems Today!

**New OHMITE  
Quick Reference  
Catalog 18 FREE**



Gives up-to-date information on the wide range of Ohmite stock resistors, rheostats, chokes and switches used in all types of applications. Helps you select the right units for each job easily, quickly. Send for Catalog 18 now — it's Free.

**Handy OHMITE  
Ohm's Law  
CALCULATOR**

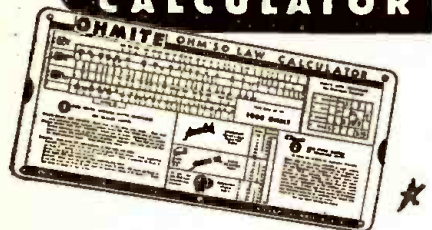

Figures ohms, watts, volts, amperes — quickly, easily. Solves any Ohm's Law problem with one setting of the slide. All values are direct reading. No slide rule knowledge necessary. Size 4 1/8" x 9".

Yours for only 10c. At your Jobber or send coupon.

**OHMITE MANUFACTURING CO.**  
4896 Flournoy St., Chicago, U.S.A.

Send Free Catalog 18.  
 10c in coin enclosed. Send Ohm's Law Calculator.

Name \_\_\_\_\_  
Address \_\_\_\_\_  
City \_\_\_\_\_ State \_\_\_\_\_ BC-July '42

**Be Right with OHMITE**  
RHEOSTATS · RESISTORS · TAP SWITCHES

# SERVICE QUESTIONNAIRE WITH ANSWERS

WILLARD MOODY

**QUESTION:** What is the decibel?

**ANSWER:** The decibel is a ratio, approximately equal to the smallest difference that can be detected by a normal ear when listening to variations in sound intensity. A decibel is equal to 20 times the logarithm of the voltage or current ratio and 10 times the logarithm of the power ratio. The voltage output of a device or the power output of a device is divided by the voltage input or current input of that device or the power input of the electrical device or machine. Frequently amplifiers, pads, filters and other electrical apparatus are rated in terms of the decibel.

**QUESTION:** How may the turns ratio of the output transformer be determined?

**ANSWER:** A 1-volt signal may be applied to the secondary of the output transformer and the primary voltage, which is in the step-up direction, can be measured using a vacuum-tube voltmeter or other high-resistance voltmeter. The turns ratio will be equal to the voltage ratio. The turns ratio squared times the impedance of the voice coil at 400 cycles will give the reflected impedance for all practical purposes. In servicing work the impedance of the voice coil may be assumed to be the voice coil resistance multiplied by the factor 1.5. In servicing, it is convenient to use a universal output transformer with several impedance taps that can be selected to match a given tube or circuit. Instructions of the manufacturer come with each transformer and show the proper method of connection for every job.

**QUESTION:** What is image frequency?

**ANSWER:** The image frequency of a radio receiver may be simply expressed as the fundamental frequency to which the dial is tuned plus twice the intermediate frequency, where the oscillator is aligned at a frequency higher than the signal. For example, assume that you have a receiver employing 175 kilocycles i.f. and that the dial is tuned to 700 kilocycles. The image frequency of 700 will be 700 + 350, or 1050 kc.

The action may be briefly illustrated. Assume that since the signal frequency is 700 kc., the oscillator frequency will be 700 + 175 or 875 kc. It is known that when you have a frequency of a given value, beating another frequency against it will produce a sum and a difference. The sum will be 875 + 175, or 1050 kc. Thus, it can be seen that the image frequency is equal to the signal frequency plus the i.f. value multiplied by 2.

Let us take the opposite case and assume that the oscillator is aligned at a frequency lower than the signal. If we have a 700-kc. signal and the i.f. is 175 kc., the oscillator will be 700 - 175, or 525 kc. If we have a 525-kc. oscillator signal, the frequencies produced will be 525 - 175 or 350 kc., and 525 + 175 or 700 kilocycles. We thus see that the image frequency will be lower than the signal frequency, since the oscillator is aligned on the low side of the signal. This image frequency is 350 kilocycles and is

exactly twice the i.f. frequency away from the signal in a negative or lower frequency direction.

When aligning short-wave receivers, image frequency is an important problem. The intermediate frequency of all-wave receivers is generally in the neighborhood of 460 kilocycles. Assume, then, that you have a signal of 7000 kilocycles. The oscillator is set at 7000 + 460, or 7460 kilocycles. Assuming that the i.f. is 460 and that the oscillator is aligned on the high end of the signal, or at a higher frequency than the signal, the image frequency will be 7000 plus twice the value of the i.f., or 7920 kc. However, in most short-wave receivers the oscillator is aligned at the low-frequency side of the signal. This would mean, in the case cited, that the oscillator signal would be 6540 kc. With this 7000-kc. signal and 6540-kc. oscillator value, the image frequency will be on the low side of the signal or 7000 minus twice the i.f. value. This means that the image frequency would have a signal of 6080 kilocycles. In adjusting the short-wave receiver, the first peak of the trimmer condenser from maximum capacity would be chosen. If the second peak were chosen, the radio frequency system of the receiver would be aligned at the image frequency and the sensitivity would suffer as the receiver is tuned throughout its dial range. This is a frequent cause of misadjustment in short-wave receivers, and a case of so-called "dead spots."

It is essential for the serviceman to get a clear conception of image frequency in order to adjust these receivers properly.

**QUESTION:** How may interference be picked up as the result of an oscillator harmonic?

**ANSWER:** Suppose that the receiver dial is tuned to 700 kilocycles and that the intermediate frequency of the receiver is 460 kilocycles. The oscillator for the standard broadcast band set will then be 700 + 460, or 1160 kilocycles. The second harmonic of this oscillator will be 1160 + 1160, or 2320 kilocycles. If a police station or very powerful amateur station is operating on a frequency in the vicinity of 2320 kilocycles and the receiver has no adequate pre-selection before the first detector, the interfering signal pick-up may be quite appreciable. A great deal of interference is laid at the door of the amateur, when in reality the real cause is poor engineering of the broadcast receiver. The F.C.C., or Federal Communications Commission takes this into account when considering cases of interference.

**QUESTION:** What is the range of the F.M. station?

**ANSWER:** The range of the F.M. station will be primarily governed by the height of the transmitting antenna. Line-of-sight propagation exists in the frequency modulation transmission spectrum, and the distance that may be transmitted in miles is given by the equation 1.56 X the square root of the height of the transmitting antenna. This is essentially the line-of-sight path at sea level. If the antenna is located on a mountain top or other similarly high-

placed position, the distance that may be transmitted is increased several times. The f.m. waves, of course, travel in a straight line and do not follow the curvature of the earth, nor are they reflected by the Kennelly-Heaviside layer. At the time of his death, Marconi was experimenting with bending of ultra-high-frequency waves, but as yet no success along this line has been achieved.

**QUESTION:** What is a simple explanation of the process of reflection of a radio wave from the ionosphere?

**ANSWER:** The angle of incidence will always be equal to the angle of reflection. If you take a rubber ball and throw it against a solid wall at a certain angle, the angle or reflection will be equivalent to the angle of incidence. If the ball strikes an angle of 30°, it will be reflected at an angle of 30° in the opposite direction. When a radio wave is sent out from a transmitting antenna at an angle of a certain value and strikes the ionosphere at, say, 30°, the reflection will occur at the same angle. The result is that the wave may be bounced against the ionosphere and be reflected back to earth, and again be reflected from the earth up to the ionosphere and down again, until it reaches the point where it is received. The skip distance, so called, is dependent to a great extent upon the frequency employed at the time of day or night that frequency is used. This explains the long-distance transmission of radio signals. Mathematical physicists at one time proved definitely that a radio wave could not be sent around the earth, but amateurs, experimenting, found that it could. The mathematicians completely overlooked the possibility of an ionized layer located 200 or 300 miles above the earth and acting as a curtain or reflecting surface for the radio waves.

**QUESTION:** What is the most efficient conductor of electricity?

**ANSWER:** Silver is undoubtedly the finest conductor of electricity available to man. The metal copper comes next on the list and prominently following copper we have aluminum and other materials, notably iron, steel and substances which conduct heat. As a matter of fact, the properties of heat conduction and conduction of electric currents are closely related. This is proved in everyday life by the great distribution of aluminum cooking utensils, which conduct heat efficiently and which also conduct electricity efficiently. It is interesting to note that high-voltage cables used for overland power transmission employ aluminum, due to savings in weight and smaller strain imposed on towers or supports. Copper is comparatively heavy by contrast with aluminum.

**CALL FOR RADIOMEN**

Radio-Craft frequently receives requests for listings of radiomen in different parts of the United States who might be available for various branches of Government work. Radiomen who have not previously registered with Radio-Craft and are citizens of the United States are asked to submit name, age, address, and classification of type of work briefly on a postcard and mail it to Radio-Craft's Emergency Aid Bureau, 25 West Broadway, New York, N. Y.

**Operating Notes**

**Trouble in . . .**

**AC-DC SETS USING 50L6 OUTPUT TUBES**

Distortion that occurs shortly after turning the radio set on is very often caused by faulty 50L6 tube. Replace with a new output tube.

JORGE ESCOBAR,  
Mexico, D.F., Mexico

**AIRLINE MODEL 62-333, 62-303 OR 62-403**

When oscillation or whistling occurs on tuning in some stations and set will not align correctly, notice whether customer has changed the A.V.C. and Oscillator metal tubes for the glass type. If so, change them, a 6H6 and a 6C5 tubes, for the metal type. Then proceed to align correctly.

JORGE ESCOBAR,  
Mexico, D.F., Mexico

**PHILCO RADIO MODEL 270 OR 270A**

If all the voltages and tubes test OK and the set brings in about two stations very weakly, the trouble can be traced to a shorted cathode condenser in the second detector circuit. The radio will not operate without the condenser.

SPARKY'S RADIO & ELEC. SERVICE,  
Hanover, Kansas.

**FARNSWORTH AKLS9**

In cases where a loud hum, sometimes tunable or inoperative on both radio and record, the trouble will usually be found by replacing the green insulated wire that runs from the variable transformer of the volume through the coiled wire shield to the terminal rear of the chassis. A spot will be found on the insulation that apparently causes a short circuit.

MARSHALL J. WAGNER,  
Baltimore, Md.

**RCA VICTOR MODEL 10T-10K**

If sensitivity of these models drops very low, check the bias switch (S7) in service diagram which is of the slide type, and is operated automatically by the range selector control. The purpose of this switch is to increase sensitivity on the short and intermediate wave bands by reducing the residual bias on the A.V.C. and detector tubes.

When this switch is turned clockwise it may stop and stick in that position and cause decrease in sensitivity. To correct this trouble, clean the contact points of the switch and lubricate the movable parts.

FRED KARPEN,  
Johnstown, Pa.

**PHILCO 1940-41**

Complaint of pushbutton drift off stations on a Philco 1940-41 with permeability tuned oscillator on pushbutton tuning can be corrected by replacing dual 370 mmf. fixed condenser that is placed across the oscillator circuit with a new Philco part or two silver mica condensers of approximate value.

MARSHALL J. WAGNER,  
Baltimore, Md.

**RCA**

Deficient crystals on record players are usually easily detected by pressing on the side of the tone arm while playing a record. Press toward, then away from the center of record, noting change in volume. Be sure that the needle is a good steel one when making the above test, as some special needles give a misleading test.

MARSHALL J. WAGNER,  
Baltimore, Md.

**EXTENDING 3-VOLT A.C. METER RANGE**

**T**HE Serviceman who owns a low-range A.C. meter that he hasn't used since filament voltages rose from 2½ volts upward will be interested in learning how I put my 0-3 Weston voltmeter to use again.

Because of the scarcity of meters information on this conversion job, which makes use of old parts, extends the range to 750 volts and includes provision for output readings, would undoubtedly be of value to other Servicemen.

I used the laminations of a burned-out transformer that had a ¼-inch by ¼-inch cross section. In this particular transformer I was able to salvage only the laminations and the form on which the wire had been wound. Assuming, however, that the Serviceman has only the laminations to begin with, the actual form can be made from about five layers of heavy kraft paper.

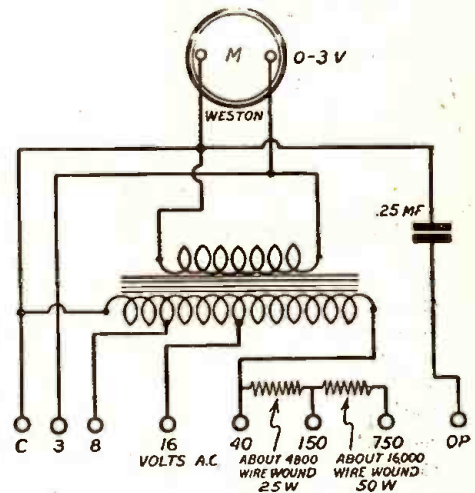

The first winding to be made is the 3-volt winding which connects to the meter as well as to the 3-volt terminals (see diagram). In my case this winding consisted of 36 turns of No. 24 enamel wire. This was followed by several layers of brown paper insulation. The secondary winding was made as follows: I wound 95 turns, brought out a tap, added an additional 95 turns, brought out another tap and added 290 turns, using No. 28 enamel wire. This gave readings of 8, 16 and 40 volts. For the higher voltages I utilized wire-wound resistors of sufficient wattage to avoid overheating.

To duplicate these resistors the Serviceman can use wire-wound resistors having slides or taps to enable him to adjust the voltage readings accurately. This can of course be done from the A.C. 110-volt line.

A .25 mf. condenser in series with a common terminal brought out to another jack permits using the meter for receiver output readings. The accuracy of this meter is surprisingly good. I have found by comparing it with other meters that it is within 5 per cent. The advantage of a transformer arrangement is that it puts sufficient load on the circuit under test and gives a good idea what the voltage under load would be.

D. V. Chambers

**EMERSON AC-DC 1941**

In cases where a sharp sixty cycle hum that sounds like an outside interference, the trouble usually disappears when a strong signal is tuned in. Replace 20-20 mf. filter condenser.

MARSHALL J. WAGNER,  
Baltimore, Md.

# War Use of Records Improves Tonal Range

*British find accuracy of aural training a valuable supplement to older classroom methods, and in teaching trainees to learn by ear all the sounds of war make marked technical advances which are expected to result in peace-time recordings of better quality and greater fidelity.*

**B**RITAIN has found a new role for the phonograph record—she is using it to teach people the art of war. In factories, in the three fighting services and in many obscure branch of war unknown to the general public the record is proving itself a valuable aid in training.

But the debt is not all on one side. In return for its usefulness in time of war, the art of recording is itself being revolutionized. Already, because of the exceptional quality of the sounds which have had to be recorded, it has become possible to register tones never previously realized, an achievement which will have much bearing upon the post-war recording of music. Much more has been learned about the flexible record, the cost of which has so far been prohibitive. But possibly the greatest benefit likely to arise from these wartime developments is in the educational field, where an entirely new technique is being evolved.

## TEACHING WOMEN MUNITION WORKERS

Simplest of all the recordings is the straight talk for the factory worker explaining how his or her work fits into the general scheme of war production. These have been enormously successful, both in giving the workers a clearer technical grasp of the subject and in encouraging them to great efforts. Then there are the training records, which teach girls new to mechanical things the purpose of various tools, such as lathes, milling machines, micrometers, and so on. Another type of record reminds them how to avoid specific faults in their work. Mechanics in the Royal Navy, the Army and the Royal Air Force make use of similar records, adapted to their special requirements.

## TRAINING AIR PILOTS BY RECORDINGS

Training establishments in the R.A.F. are making use of records, either for the technical ground staff or for flying crews. An important part of the Link trainer, the device in which pilots learn "blind" flying, is the reproduction on phonograph records of the sounds of engines, etc.

Records of the sounds of machine guns,

of different calibers of shell and of signals of various kinds are in use every day, as are recordings of orders for loudspeaker reproduction and for immediate operational requirements.

Records do not, of course, entirely replace the human instructor, nor are they intended to do so. But they do give a clear and accurate rendering which can be repeated as often as it is needed. No longer do "rookies" have to brave the wrath of the tired sergeant-instructor when they have not quite grasped the subject being taught; they need only ask for the record to be played over again. Another feature of the record is its absolute accuracy. Everyone knows how easy it is inadvertently to distort messages, instructions, etc., when they come second, third or fourth hand, by word of mouth or even in writing. But the phonograph record tirelessly repeats the original statement word for word and cannot be altered.

## APTITUDE TESTS FOR CODE MEN

The record is also an important medium for aptitude tests, for example, with radio code men. This job calls especially for a good sense of rhythm, for the code man listens not to the actual dots and dashes but to the rhythmical forms they make. It is often very difficult to tell whether trainees will make good code men until they have gone through their preliminary training, for however intelligent they are they may be found entirely lacking in this particular quality. Before they learn a single letter of the code the men are given a test in which various sounds are played over to them, and they are asked to distinguish between them. In a great number of cases this weeds out men who are unsuited for the job.

## ONE OF THE BIG INVENTIONS OF THE WAR

Most interesting of all the devices now used is one which combines vision and sound, like a "talkie" with phonograph records. The joint work of an engineer, a recording expert, and a man skilled in photographic layout, this system, called the

Synchrophone, has ushered in a new era in training and instruction.

Better than a film because it can be shown in daylight and stopped at any point and repeated, better than blackboard and chalk because an infinite variety of moving designs can show "how it works," better even than books because several long, descriptive chapters can be conveyed in a few moments, this is one of the inventions that show up in every war and become a part of history. There would be a fascinating story in any of the instruction series shown on this instrument, but this is not the time to tell it. Indeed, there are very few outsiders who share the secrecy which surrounds the invention. Even the manufacturers of the records do not see the pictures, and the picture-makers do not hear the records.

## EVERY AUDIBLE TONE CAN NOW BE RECORDED

These are some of the uses to which phonograph records are put in training the men and women in the Services and on the home front. But there are many other uses, from the recording of speeches supporting war savings campaigns and giving instructions to the civilian population in emergencies to the part it plays in intelligence work. Propaganda also makes full use of it with recorded talks sent overseas to broadcast from minor radio stations abroad.

In all this work British recording engineers have been faced with technical problems of great intricacy and, as has been indicated, they have added much to their knowledge in solving them. The necessity of recording with absolute fidelity those sounds never before heard on a disc has considerably broadened the spectrum of sound. The tonal range has been stretched to three or four octaves above the highest note on a piano and to a full octave below the lowest piano note. In short, they have pushed recorded sound to the limits of the useful range of audibility.

All this will mean more perfect recording of music when peace returns, and better value for money in the quality range of records.

(From RADIO-CRAFT'S London Correspondent)

# RECORDS SOLVE OVERSEAS LANGUAGE PROBLEMS

**B**RITISH soldiers, sailors and airmen are learning to speak Chinese by way of phonograph recordings, according to information from the Linguaphone Institute of London.

A big demand has grown up in the last few months for recorded language courses, not only in Chinese but also in Russian. In many parts of the country men in the services have formed study groups to help them to learn French and German as well as Russian and Chinese. Policemen in Britain are forming groups to give them-

selves a knowledge of German and Russian. Home Guards are also occupying their spare time in picking up German at their guard posts.

The Friends' Ambulance Unit which worked on the Burma Road, has had courses in Chinese. Courses in Spanish have been sent to America for the U. S. Air Force, and other U. S. forces are learning Russian.

A record course in English is popular with sailors in the Norwegian and Dutch merchant services, and French Canadian

soldiers are also using the record system. The Free Services of France, Norway, Czechoslovakia, Poland and Holland are about to learn to speak English in a course which is being recorded with the aid of B.B.C. announcers.

Nine out of ten of the language courses now being produced in Britain are going to the services. The chief demand is for Russian, Chinese and German, although courses in Arabic, Hindustani and Japanese have been taken up by certain service personnel.



# RCA SOUND INSTALLATIONS EXCEED RATE OF 5 A DAY

The actual number of new uses to which sound amplifiers have been put since the National Emergency was declared will not be known until after the war, when the numerous applications will be permitted to be disclosed publicly.

There are, however, many types of installations now being made which are performing useful functions in a varied number of applications, and general information on these are available.

George Ewald, RCA Commercial Sound Division manager, reports that 155 sound-system installations, including many of novel and unusual design, were completed during a recent 30-day period.

Sound facilities and fire-alarm signals at a mid-western aircraft plant have been tied in through the installation of a complete plant-wide sound system. By means of a special relay panel, the system permits fire signals to take precedence automatically over any other function, regardless of how the controls are set.

The system employs a signal-generator functioning as a fire alarm and coding signal generator, with a beat-frequency oscillator as time and paging signal generator. Distinctive tones are obtained by setting the two devices at different frequencies. Equipment in the control station covering the flight area can be tied in with the main system by throwing a single switch. The two guard towers at the plant are covered by additional systems with speakers mounted on turrets above the searchlights.

Installation of a paging system in the freight transit sheds of the Mare Island Navy Yard has resulted in a marked speed-up in freight movements. The system has overcome the sharp differences in noise levels in the sheds, and announcements can now be clearly heard at all times.

Two industrial guard systems have recently been installed at the Minneapolis Honeywell Regulator Company and at General Mills, Inc. These allow instant communication between guard stations at plant entrances and look-out stations and the central guard office as well as for the transmission of alarm signals. The equipment installed offers protection against any possible action of saboteurs.

RCA equipment has been installed in the laboratories of the Minnesota Department of Highways. The equipment, consisting of a standard amplifier, loudspeaker, crystal cartridge, and oscillograph, is being used in an effort to discover types of concrete construction capable of withstanding destructive vibration.

The underground "waiting" room of the Inland Steel Coal Mines in West Virginia has been equipped with sound facilities. Provision is made for general announce-

ments, safety talks, transmission of emergency alarms, and a long distance telephone connection permitting the president of the company to address the men in the "waiting" room from his desk in Chicago.

Four complete paging systems have been installed at the Naval Air Training School, University of Iowa, Iowa City. The equipment connects the field house, administration offices, and dormitories for instant communication, paging and time signals.

Two RCA sound system installations marking an important step in the acceptance of industrial sound by established, conservative firms were recently completed at Warner-Swazey, Inc., and at the Cleveland Graphite Bronze Company of Cleveland, Ohio. The two companies required plant-wide systems affording facilities for paging, signaling, sound distribution and other sound needs necessary to the operation of the plants.

Sound facilities for air raid and fire alarm signals, music reproduction, paging and general announcing are now available at Kaufmann's, Gimbel Brothers and Frank & Seder department stores in Pittsburgh; at Marshall Field's in Chicago; and at Sears Roebuck in Houston, Texas, through the installation of RCA sound systems. The department store installations were placed by Hamburg Brothers, RCA Victor Distributing Corporation, and Sound Sales & Engineering Company of Houston, respectively. The Pittsburgh stores report exceptional results promoting "special" sales by means of the sound systems. A general increase in sales throughout the stores has also been noted since the installation of the systems, and executives report that the music programs have a favorable effect upon employees in reducing fatigue.

A group of Carnegie Illinois Steel Company workers have purchased a portable RCA sound system to provide facilities of music, safety talks and general announcements at their meetings. The employees of the Pittsburgh plant acquired the system from Hamburg Brothers of that city.

A portable RCA public address system has been presented by the Joshua Hendy Iron Works to its Employees Association for use at meetings, entertainments and other such functions. The equipment was obtained from the Leo J. Meyberg Company of San Francisco.

During the same 30-day period RCA sound systems were installed in 56 industrial plants, 27 government projects, 20 churches, 23 schools and colleges, a hospital, a hotel, and in such miscellaneous locations as department stores, radio stations, funeral homes, bowling alleys, a Red Cross Headquarters, a Salvation Army post, a fuel company, a restaurant and a golf club.

## Women Urged to Study for Station-Operator Jobs

Radio engineering authorities say that women can easily meet the requirements now in effect for restricted radiotelephone operator permits. It is believed that persons of normal intelligence should be able to pass the examination for the restricted radiotelephone operator's permit after 8 or 10 hours study of the FCC study course for this examination. The Study Guide and Reference Material for Commercial Radio Operator Examinations may be obtained from the Superintendent of Documents, Government Printing Office, Washington,

D. C., for the sum of 15 cents.

This latest action of the FCC wartime policy of coming to the aid of broadcast stations on the matter of operator and operation requirements is specifically directed to the problem of low-powered broadcast stations operating on frequencies assigned for local services. There are 441 licensees benefited by this action. Earlier FCC relaxations of operator requirement rules with respect to broadcast stations were published in the June issue of *Radio-Craft*, page 605.



**4 STANDARD TYPES**  
of Amperite Regulators replace over 400 types of AC-DC Ballast Tubes now in use.

Amperites are real REGULATORS... have patented Automatic Starting Resistor which prevents initial surge and saves pilot lights... Ask Your Jobber.

# AMPERITE

THE *Simplest* WAY TO REPLACE **BALLASTS**

WRITE FOR REPLACEMENT CHART

AMPERITE Co. 561 BROADWAY, NEW YORK, N. Y.



**YOUR ONE DEPENDABLE SOURCE OF SUPPLY... Your ALLIED Catalog!**

Radio plays a big part in our march to Victory. American radio must stay at top efficiency in the home, in factories, in research labs, in instruction centers. You can help serve on every radio front by depending on ALLIED for Everything in Radio. Your ALLIED Catalog has everything—Radio Receivers; Test Equipment; PA and Intercom Systems to speed up production; 15,000 Parts for service and replacement work; for industrial and research application; Tubes, Books, Tools—backed by complete stocks and speedy service. Keep your ALLIED Catalog handy!

**SEND FOR YOUR FREE COPY NOW!**

**ALLIED RADIO CORP.**  
ALLIED RADIO CORP.  
833 W. Jackson Blvd., Dept. 2-G-42  
Chicago, Illinois.

Send me your FREE 1942 Radio Supply Catalog.

Name .....

Address .....

City ..... State .....

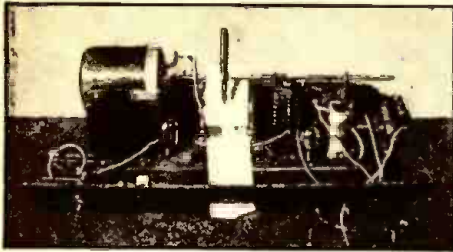

Photograph of Vibrator Tester with front panel tilted forward from chassis to show placement of parts.

As Mr. Carpenter points out it is very difficult to prove to the average customer that a "B" supply vibrator needs replacement. With the recording analyzer described by the author, it becomes a simple matter to prove to the customer that his worn vibrator should be replaced. The tester can be made from odd parts.

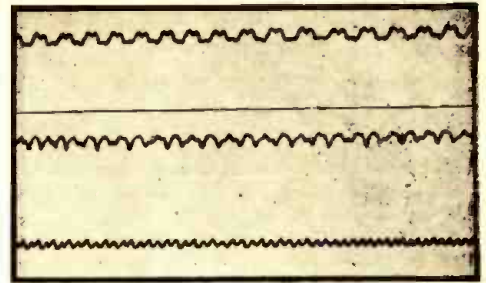

Recorded graphs showing responses of good and worn vibrators, in the order (reading downward) of "good," "going" and "gone."

# Making a VIBRATOR Tester

H. L. CARPENTER

IN the last few years, the auto radio has become one of the greatest sources of profit within the reach of the radio serviceman. However, there is one profitable item that is too frequently neglected, because the serviceman has no means of definitely proving the state of its deterioration. This neglected part is the vibrator, without which we would not have the millions of auto radios now in service. The vibrator is as important to the auto radio receiver as is the power company's dynamo to the radio in the home, yet it will fail gradually so that its failure is not noticed until it is completely worn out. These old and sluggish vibrators will cause many ex-

tra noises and a loss of power, even though the radio still operates.

It is difficult to convince many car owners that they need a new vibrator before the old one fails entirely, unless we have some way to show the difference of operation between his old vibrator and a new one. About ninety percent of my service work is on auto radios so I have developed the tester here described and have found it to be a convincing aid in vibrator selling.

This tester works on the principle of the oscillograph that was used in the factory and laboratory before the advent of the cathode-ray tube. Instead of showing the

wave form on the screen of a tube, it writes it on a strip of paper so that it may be preserved and compared with others. In the accompanying graphs are shown the wave from a new vibrator and those of other vibrators in different stages of wear. The top wave form shown is that of the new vibrator, a Mallory type 4-4 universal vibrator, such as is used in the majority of sets. The center graph shows the same type vibrator after being in service for eleven months. The bottom wave form is from a vibrator that has reached the end of its operation life cycle. This last vibrator caused fuses to burn out after a few minutes operation. The operator can make several graphs of vibrators in various stages of wear and make a chart for reference in future tests.

Diagram showing arrangement of Vibrator Tester.

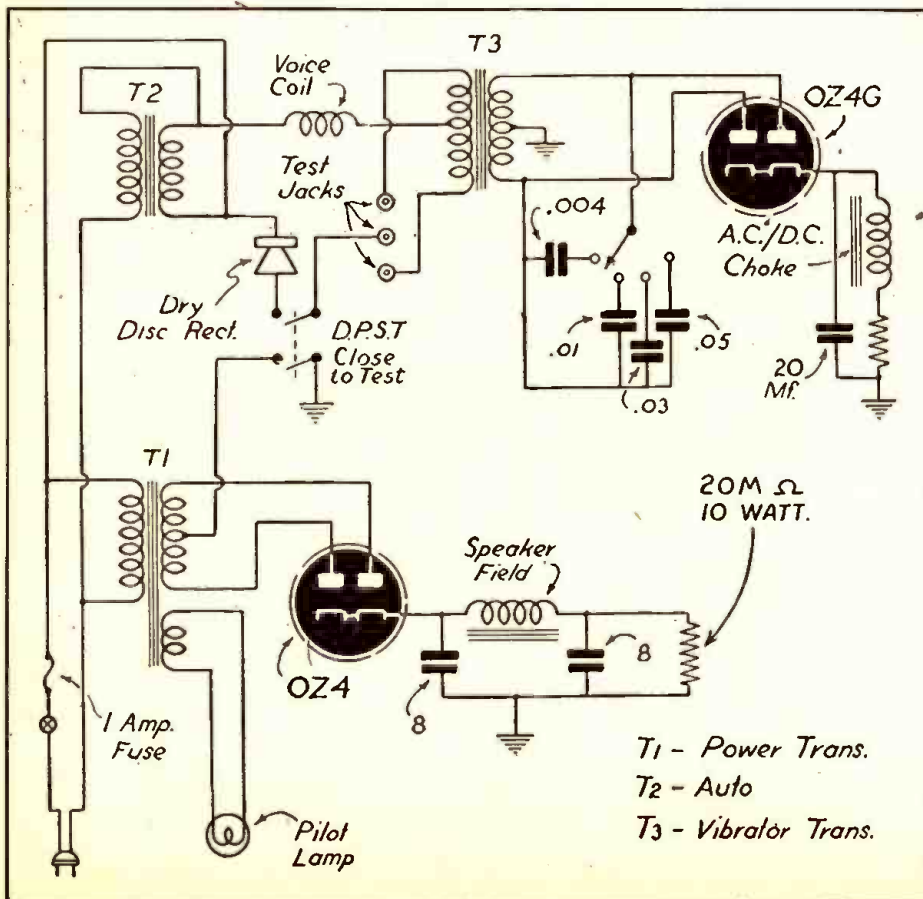

T1 - Power Trans.  
T2 - Auto  
T3 - Vibrator Trans.

## CONSTRUCTION

The construction must be left partly to the reader's own imagination, as it is built mostly of odds and ends from the junk box. The first thing to mount on the chassis is the motive power for the pen. This consists of an old dynamic speaker, with the cone removed from the voice coil. The larger the voice coil the more power we will have in the drive. The field coil is connected as shown in the diagram, using the OZ4 tube as rectifier so that the tester will operate immediately, without waiting for tubes to warm up. A fibre disc is cemented to the voice coil with a hard-drying cement (Trestor's cement is best), and a brass screw, fastened to the center with a brass nut. To this screw is fastened a small brass or steel rod, which runs through a guide at the other end of the chassis. For this rod and guide I used the two top sections from a telescopic antenna, cut to about eight inches in length. The top section serves as the rod and the second section as the guide or bearing. This rod must move freely and have no drag, except that exerted by the voice coil spider. To the center of this rod is soldered a clip to hold a fountain pen, so that the point of the pen is slightly in front of the rod. The paper used is a roll of adding machine paper and is mounted in the frame of a tuning condenser taken from an old radio set. A roller is fastened to the front or top of the frame so that the paper may be drawn smoothly under the pen, with the pen resting directly above the roller.

# CONDENSER-TESTING ADAPTER

JAMES R. LANGHAM

We now have a *motor-driven pen* that will oscillate back and forth across the paper, matching in frequency and amplitude, the voltage applied to the armature coil. The power for this motor is derived from a transformer and dry-disc rectifier from an old A.C. dynamic speaker. The transformer is connected as an auto-former so that it will deliver sufficient current to operate the vibrator, and the rectifier is connected with all the plates in series so that it is operating half-wave. This hookup will have an output of approximately six volts. One side of the six volts output is connected through the armature coil to the center-tap of the vibrator transformer. The other side to the center test jack through one pole of a DPST spring return switch. The switch I used was the lever type such as used in private address systems. The high voltage side of the vibrator transformer is used in the conventional manner with a OZ4G tube to give the approximate operating conditions under which the vibrator should be tested. The load for this tube consists of a filter choke from an A.C.-D.C. set and a 20 mf. 400 volt condenser with a 20,000 ohm 10 watt resistor in series with the choke. Four buffer condensers are used and the proper one may be selected by a tap switch as shown. These condensers must be rated at a minimum of 1000 volts.

In mounting the OZ4G tube, it should be as close to the panel as possible, and a hole cut in the panel directly in front of it. This will show if the vibrator is putting out enough voltage to operate a radio set as it will cause the tube to glow.

To test a vibrator, connect the center test jack, using short leads with small battery clips, to the reed or ground of the vibrator. Connect the two outside jacks to the movable points of the vibrator and pull the paper slowly through the slot in the panel, while holding down the test switch. A little practice will be needed to learn the proper speed at which to pull the paper through.

The only parts that need be purchased for this tester are the roll of paper and the pen. The pen should be one with a round point. The one I used was an INK-OGRAFH. Any parts distributor will be glad to furnish a base diagram chart for all types of vibrators, and after a little experimenting the builder will become acquainted with the most popular types, so that he can connect them for testing without further reference.

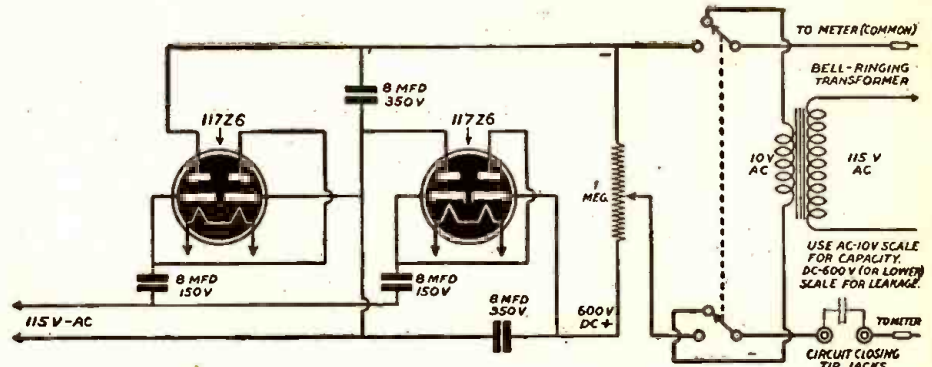

**H**ERE is an adapter that will convert any AC-DC volt-ohmmeter into a condenser tester. It is simple, inexpensive and remarkably effective in determining the value and leakage of a condenser.

Two 117Z6 tubes in a voltage-quadrupler circuit give 600 volts of direct current. This permits testing of either a paper or mica condenser at rated voltage for leakage by putting the condenser in series with the meter. A one-megohm control is used for obtaining the approximate rated voltage of the condenser and a circuit-closing pair of tip jacks serves to regulate the proper voltage before inserting the condenser.

As for capacity tests, most meters have a 10-volt AC scale, and with an ordinary bell-ringing transformer (35c in most dime stores) you can obtain 10 volts very cheaply. With the condenser in series with the meter you will find that different capacities deflect the needle by different amounts. Reactance varies inversely as capacity. Meters of different sensitivity will require different calibration. For my own meter I have made a scale based on observation of the amount of deflection for known capacities. I have printed my scale on the meter itself in red ink, but a conversion chart would do just as well.

To test a condenser for capacity you simply throw the switch connecting the transformer and disconnecting the DC. Then turn the meter to the ten-volt AC

scale and insert the condenser in the jacks. The needle will drop to some value, say 4.5 volts. On my meter that would mean the capacity was .025 mf. If the needle does not move, the condenser is shorted. If it goes to zero the condenser is open. Since only ten volts are applied, low-voltage electrolytics can be tested without fear of harming them.

For leakage, throw the switch the other way. Connect the DC voltage scale of the meter and adjust the control for the rated voltage. Then insert the condenser. Any voltage on the meter will be leakage. *Caution:* If the condenser shows no leakage, tap it. Tap it strongly and in several directions before turning the meter to a lower scale. A good condenser should go right down to the 200-microamp. scale without any sign of leaking.

A further test of leakage is to raise the voltage across the condenser some ten or twenty percent above the rated voltage. A good condenser will stand it perfectly. A poor one will leak. In this way you can get an idea of how it would behave under a starting surge.

This device cost me about \$2.60 last year when I built it. The parts might be a little higher now, but not much. In conjunction with a small volt-ohmmeter its usefulness is extraordinary. I have never had a condenser pass the test of this device and not work perfectly in a set.

## EVERYBODY'S SALVAGING

A company that formerly burned off the rubber insulation from copper wires and cables so as to salvage the copper, now salvages the rubber by squeezing the wire or cable through a set of rollers, thus permitting the rubber to be easily removed from the wire.

All the short stubs of welding rods are saved for return to the welding supplier for credit.

All worn out or broken steel punches, dies, drills and high speed tools are salvaged.

On its lead-burning operations, it is supplying the lead-burners with wooden buckets so that the lead scrapings can be salvaged.

All burned out electrical fuse cases are collected and returned to the manufacturer for refilling.

Dry coil batteries of all types, including the flashlight types, are collected when worn out for the zinc salvage.

**THANKS**

**TO YOU,  
MISTER  
SERVICEMAN**

Many Jobbers still have SUPREME Instruments in Stock. Tell us the instrument you want. We'll do our best to get it for you.

From the first SUPREME instrument, and through the fourteen years since, the acceptance, loyalty and co-operation of servicemen everywhere are largely responsible for the excellence of SUPREME instruments today—and our ability to produce them in quantity for our armed forces. If you could not get the new equipment you wanted this year, just remember that it is now doing duty for us in some spot on the globe and represents part of your contribution to Victory.

**SUPREME**

INSTRUMENTS CORP.

GREENWOOD, MISSISSIPPI, U. S. A.

# MUTUAL INDUCTANCE

A Simple Method of Calculation for Single-layer Coils on the Same Form

T. H. TURNEY, PH.D.

Prof. Nagaoka's formulas and figures for the inductances of single-layer coils can be used to find the mutual inductance of two coils when both are wound on one form. The two coils may be close together or else they may be separated by an air space. The first case is shown in Fig. 1 and the second in Fig. 2, the latter being the more difficult.

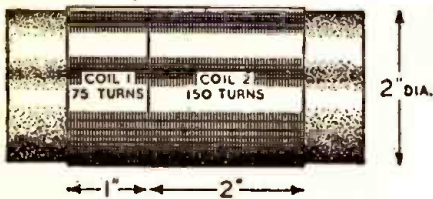

Fig. 1—Two coils touching end-to-end.

Once the mutual inductance is calculated, the coupling coefficient may be calculated from the formula

$$k = \frac{M}{\sqrt{L_1 L_2}}$$

The  $L_1$  and  $L_2$  are the self-

inductances of the two coils and  $M$  the mutual inductance. The "k" is the coupling coefficient. Capital K is reserved for the constant in Prof. Nagaoka's formula or for the constant in the particular form of his formula in use in finding the self-inductances.

His work has been described in a recent article\* and the formula

$$L = \frac{N^2 r K}{10^9}$$

is given with a table of values

of K for various ratios of  $\frac{r}{l}$ .

The way in which those results can be used to calculate mutual inductances is as follows. The total self-inductance ( $L_{1,2}$  say) of two coils  $L_1$  and  $L_2$  in series, aiding each other, is known to be the sum of their self-inductances plus twice the mutual inductance,

$$L_1 + L_2 + 2M = L_{1,2}$$

If, then, in Fig. 1 the inductance of the whole coil is calculated, as  $L_1$  and  $L_2$  can be calculated too,  $M$  is the only unknown; and so

$$M = \frac{1}{2} (L_{1,2} - L_1 - L_2)$$

The inductance of the whole coil  $L_{1,2}$  and the inductances  $L_1$  and  $L_2$  are calculated in accordance with the article in the April, 1941, issue.

Take the following as an example of the calculation of mutual inductance. Let the coils be 1 inch diameter, let the first be of 75 turns 1 inch long and the other 150 turns 2 inches long, the two coils just touching

end-to-end as in Fig. 1. In finding inductances it is the ratio  $\frac{d}{l}$  which is the

important figure used by Prof. Nagaoka to obtain from his curves the value of his constant K. This is put into the formula for inductance. Some writers use

$$\frac{r}{l} \text{ which is half } \frac{d}{l}$$

In this example the ratio  $\frac{d}{l}$  is 2 for coil 1

and 1 for coil 2 making  $\frac{r}{l} = 1$  for the

first coil, a half for coil 2 and one-third for the whole coil.

This makes  
 $L_1 = 297$  microhenrys.  
 $L_2 = 775$  " "  
 and  $L_{1,2} = 1285$  " "  
 and so  $M_{1,2} = \frac{1}{2} (1285 - 297 - 775) = 106$  microhenrys.

The coupling coefficient in this case, is given by  $k = \frac{106}{\sqrt{L_1 L_2}} = 0.22$ .

### SPACED COILS

The coil in Fig. 2 may be thought of as the whole coil (if one imagines the empty space wound) less the center portion. If, then, the inductances are called  $L_1$ ,  $L_c$  and  $L_2$  these may be calculated separately by the formula given by Nagaoka. Then the mutual inductance between  $L_1$  and  $L_c$ , the mythical center coil, may be calculated as shown above. Let it be called  $M_{1,c}$ . The mutual inductance between the center coil and coil 2 may also be found. Call it  $M_{c,2}$ . The inductance of the whole length with the center portion (if it had been wound) may be calculated, so we find that the inductance of ( $L_1$  and  $L_c$  and  $L_2$ ) =  $L_1 + L_c + 2M_{1,c} + L_2 + 2M_{c,2} + 2M_{1,2} = L_{1,2}$ , say.

Then  $2M_{1,c} = (L_1 \text{ and } L_c) - L_1 - L_c$  which is  $L_7 - L_1 - L_c$  if we call  $L_7$  the inductance of  $L_1$  and  $L_c$  in series. Similarly if  $L_2$  is  $L_c$  and  $L_2$  in series,  $2M_{c,2} = L_2 - L_c - L_2$ . Then  $L_x = L_1 + L_c + 2M_{1,c} + L_2 + L_c + 2M_{c,2} + 2M_{1,2}$  by adding and subtracting  $L_c$ . Now put in the value  $L_7$  and  $L_x$ .

Then  $L_x = L_7 + L_2 - L_c + 2M_{1,2}$  making  $2M_{1,2} = L_x - L_7 - L_2 + L_c$ .

There are, then, four inductances to be found in calculating the mutual inductance, so the rule is, when finding the mutual inductance between two coils  $L_1$  and  $L_2$  with a space between, to imagine the space to be wound, and calculate its inductance, and the inductance of the whole coil, and that of the left-hand and center section, and also that of the right-hand and center section regarded as a single coil. Add the first two, add the last two and take the differ-

ence of those last two sums. The result is twice the wanted mutual inductance.

As an example let us find the mutual inductance between two coils, one 1 inch long of 40 turns and one 2 inches long of 80 turns, the space between being  $\frac{1}{2}$  inch. The diameter is given as two inches, as shown in Fig. 3.

There are now four coils to be calculated (the half-inch space would take 20 turns), so the coils are (Fig. 2).

- X  $3\frac{1}{2}$  inches long, 140 turns, inductance 447.6 microhenrys.
- Y  $\frac{1}{2}$  inch long, 20 turns, inductance 29.2 microhenrys.

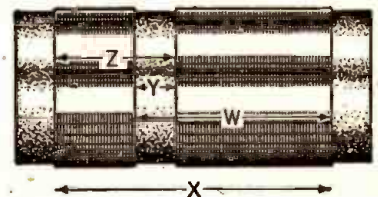

Fig. 2—Two coils of equal diameter but with a space between.

Z  $1\frac{1}{2}$  inches long, 60 turns, inductance 153.5 microhenrys.

W  $2\frac{1}{2}$  inches long, 100 turns, inductance 296.0 microhenrys.

Thus  $2M_{1,2} = 447.6 + 29.2 - 153.5 - 296 = 27.3$  and  $M_{1,2} = 13.6$  microhenrys.

This result is of interest because it does show how little is the mutual inductance of two such coils with half an inch of space between them. This explains why such a pair of coils might fail to oscillate in, say, an octode oscillator circuit.

Since  $k = \frac{M}{\sqrt{L_1 L_2}}$  and since  $M$  involves

the sum and difference of simple self-inductances, any factor in the formula which is the same for an entire calculation will cancel.

Take the variation of the Nagaoka formula given in the *Wireless World* (April, 1941).

It is 
$$L = \frac{N^2 r K}{10^9}$$

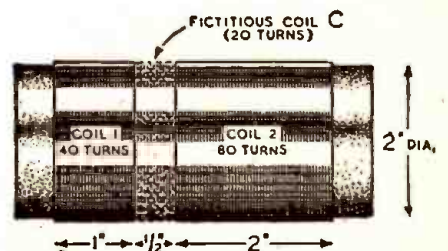

Fig. 3—Two coils with a space showing inductances which must be calculated to find the mutual inductance and hence the coupling coefficient.

\*"Inductance Calculations," by S. W. Amos, *Wireless World*, April, 1941.

the factor K is found from a table or a curve plotted against values of  $\frac{r}{l}$ .

Since the total turns N come in, and depend on l, N<sup>2</sup> depends on l<sup>2</sup> or for a given radius on  $\frac{l^2}{r^2}$ . Thus, if the K in the

table is divided by the factor  $\left(\frac{r}{l}\right)^2$  the

quantity  $\frac{Kl^2}{r^2}$  becomes a measure of inductance. This, then, can form a new factor

which may be called K' tabulated against  $\frac{r}{l}$

just like the old K but now when one looks up K' it is a measure of the inductance as it includes the number of turns, and when one wants only the coupling coefficient (that is K, and not M), the 10' and the "r" and also the "turns per cm" contained in N all cancel, so one may look up K' for inductance of the coil L<sub>1</sub>, K' for L<sub>2</sub> and K'<sub>T</sub> for the total coil. One may then subtract these and divide thus:

$$k = \frac{\frac{1}{2} (K'_T - K'_1 - K'_2)}{\sqrt{K'_1 K'_2}}$$

Putting this into a formula makes it look more difficult than it really is. The same method is directly applicable to the more complicated case of a coil with a space.

One may use K' then as the inductance of the coil in calculating the coefficient of coupling, and to avoid any working out of the separate inductances just take a figure from a table for each one, then begin subtracting. The writer has prepared a brief table of K' from which curves can be plotted or intermediate values extrapolated.

TABLE OF FACTORS FOR CALCULATING COEFFICIENT OF COUPLING

$\frac{r}{l}$	K'	$\frac{r}{l}$	K'
0.1	363.2	1.1	18.03
0.2	167.7	1.2	15.84
0.3	103.8	1.3	14.05
0.4	72.55	1.4	12.55
0.5	54.36	1.5	11.29
0.6	42.60	1.6	10.22
0.7	34.48	1.7	9.309
0.8	28.59	1.8	8.320
0.9	24.17	1.9	7.821
1.0	20.74	2.0	7.213

The table may be used to check the coil shown in Fig. 1 as follows:

Coil 2  $\frac{r}{l} = \frac{1}{2}$ , so K' = 54.36

Coil 1  $\frac{r}{l} = 1$ , so K' = 20.74

Whole coil  $\frac{r}{l} = 0.333$ , so K' = 90

Then 2M is represented by

$$90 - 54.36 - 20.74 = 14.9$$

or M by 7.45 and L<sub>1</sub>, L<sub>2</sub> by 54.36 × 20.74 so

$$k = \frac{14.9 \times \frac{1}{2}}{\sqrt{54.36 \times 20.74}} = 0.22$$

which agrees with the longer calculation given earlier.

—Wireless World, London.

**Dependable!**

That word "Dependable" is very closely associated with Meissner products; in fact, they are inseparable companions. Today, as never before, we are guarding Meissner quality, knowing as we do that throughout the world Meissner products are being called upon to give extra performance and bear a heavier burden. We know they have the stamina to carry through.

Perhaps it is largely because of their dependability that Meissner products have become so widely accepted.

**Meissner**  
MOUNT CARMEL, ILLINOIS  
"PRECISION-BUILT PRODUCTS"

**HOME-MADE ANTENNA SET COUPLERS**

Figs. 1, 2 and 3 show the simple method by which a single antenna may be used to serve all of the receivers in your home; does away with makeshift antennas and interference, when sets are tuned to different stations. Coil (A) consists of 20 turns of the antenna lead-in wire on a large spool at each receiver. Coil (B) may be 20 or more turns with one end dead, for inductively coupling each set. A layer of friction tape is placed over the completed windings on the spools which may be mounted in or near each receiver.—Marion F. Criswell.

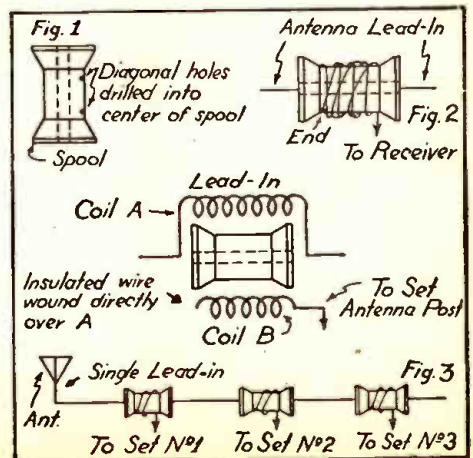

# TRANSMITTER ADJUSTMENTS

*Wartime curtailment of amateur transmitter operation paradoxically has increased the need for knowledge of transmitter adjustments, since an increasing number of men must perform such operations in factories producing war equipment.*

WILLARD MOODY

THE adjustment of a radio transmitter is generally specified as a definite step-by-step procedure originated by the designer or by an engineer who has gone over the original design and taken the "bugs" out of it. But, however well the principles of adjustment may be known, few books give a simple, accurate and easy-to-grasp explanation. We hope to set forth these principles in an understandable light.

## THE CRYSTAL OSCILLATOR

The logical place to start in tuning the transmitter is at the crystal oscillator. In Fig. 1 a circuit diagram of a fundamental system is shown and also some curves on the action of the circuit are given. Tube T1 is the oscillator tube and T2 is the buffer. The tube T1 is usually a pentode or high-mu triode, since the higher the gain of the tube, the less is the grid-current flow at radio frequencies, and less heating of the crystal results in improved frequency stability and greater safety of operation.

The first procedure in adjusting such a system would be to put a plate voltage of lower intensity on the crystal-oscillator tube's plate, with voltage removed from the tube T2. The tap on Lp1 would be adjusted for loose coupling to the buffer and the circuit of the oscillator would be tuned for minimum plate current, first setting the

tuning capacity at minimum and then tuning toward maximum capacity. Around point 3, as shown in Fig. 1, the plate current would start to dip and be registered on the ammeter A1. The tuning would be continued, Cp1 being adjusted for increased capacity until point 1 is reached and the plate current takes a sharp climb upwards. If the dip occurred at 70 on the dial and the climb started at 80, the dial would be reset to 72.5, or in the region of optimum operating stability. The coupling between Lp1 and T2 can now be increased by moving the tap on Lp1 higher and toward the plate of T1. The current indicated by A2 would then increase and Cp1 would be returned for minimum plate current dip. The condenser capacity would then be reduced by a slight amount, the previous settings serving as a guide, so that the operating point of Cp1 and the crystal circuit is in the region of best stability as indicated by the curve. In order to get any rectified grid current A2, some plate voltage at reduced intensity would be needed for T2. Neutralization of T2 could then be carried out, trimmer Cn being adjusted so that variations in the capacity of Cp2 have negligible reaction on the meter readings of A2. Increased voltage is then applied to T2 and Cp2 is adjusted for minimum plate current, which condition occurs when the buffer frequency is the

same as the oscillator frequency. Condenser Cp2 may then be varied slightly above and below the operating frequency and meter A2 watched. If the reading shifts appreciably, condenser Cn is given another adjustment, until changes in Cp2 produce no appreciable changes in A2 readings.

The tightest possible coupling between Lp1 and T2 is desired in order to insure minimum R.F. current in the crystal X. However, the coupling cannot be increased to a value greater than a certain figure determined by trial. Too tight coupling will pull the oscillator out of the oscillating condition. A reasonable amount of coupling is selected, giving low oscillator grid current without stopping oscillation. By using a low-power oscillator tube, the oscillator may be run with light loading and only moderate coupling between Lp1 and T2. Increasing the power of T1 means more critical adjustment and greater danger of breaking the crystal. Loading of a high-power oscillator is needed to limit crystal current. In the circuit shown in Fig. 1, the buffer is, of course, operating as a Class C stage, which means that the bias on the tube is set at a value equal to twice the cut-off value. The cut-off bias is the normal operating plate voltage of the tube divided by the tube's amplification factor. Part of this bias is developed by the grid leak, Rg2 with the remainder being supplied by a fixed bias supply, such as a battery of stabilized rectifier-transformer system.

## PRACTICAL ADJUSTMENT OF HIGH POWER CLASS C STAGES

It is realized, naturally, that all tubes used in a transmitter have definite limitations with regard to the permissible current that any electrode may carry and the potential difference between elements is also limited by the design of the tube, as an exceedingly high potential may, for example, cause an arc or break-down within the tube and ruin it. For these reasons, and for the purpose of gaining maximum life during service from any tube, the manufacturer of the tube specifies certain conditions which must be met as to grid current, plate current and power output. The function of the operator is, therefore, merely to set the circuit parameters in accordance with the design specifications and to adhere as closely as possible to those parameters.

However, for the purpose of investigation, let us suppose that we increase the grid current. What will happen to the plate current of the tube? The plate resistance of the tube, and therefore its plate current, will change, the plate current becoming smaller and the plate resistance becoming higher. The power in the plate circuit will vary according to the square of the current or voltage. But, an important point is that the tube delivers maximum power to the load when the load impedance is the same as the plate impedance of the tube. This means, then, that we can juggle the load and plate impedances until we get maximum power output. If, in a given transmitter, the cir-

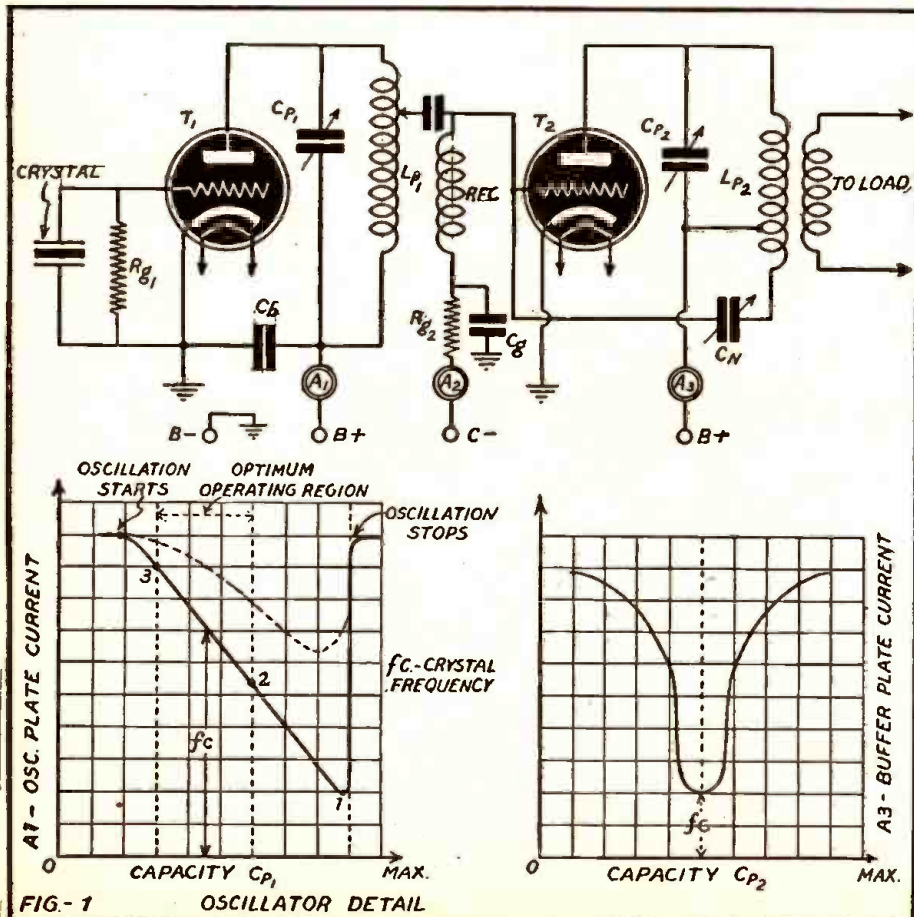

FIG. 1 OSCILLATOR DETAIL

circuit impedance is fixed by the designer, we must simply adjust for the correct tube impedance by setting the grid bias, grid excitation and plate voltage to values that will work within the limits of the circuit constants. In some cases, we may tap down on the plate coil to get an impedance match of better accuracy between tube and load.

It might be said that the greatest plate power the tube is capable of handling would be the plate power that does not produce appreciable heating when the grid bias is set for zero. The point of maximum plate power for zero bias, without heating, is not of course the point of filament emission saturation—nor anywhere near it. The tube's filament will have enough emission power to burn up the plate and wreck the tube if the plate voltage is raised to an unsafe level. This explains why a tube can go sky high when excitation fails in a stage designed for grid-leak bias only.

By raising the bias, we raise the permissible voltage that can be applied to the plate and keep the plate power down. The increased plate resistance means a better match to the high impedance plate tank and more absorption of power by that tank. It is obvious, then, that by taking a little more than usual power from the driver stage that the bias can be increased by grid-leak current, but this power is lost and is serving no useful purpose. Fixed bias, obtained by means of a stabilized power supply, means comparatively little loss in power, since the system is a potential type and not a current type. That is, grid potential is taken from a battery and the circuit current may be quite low if the exciting voltage just dips over the peak of the bias.

We might go on indefinitely, increasing the bias to a very high value, increasing the plate voltage to a high potential, but for the fact that the tube would break down when the potential difference between grid and cathode or between grid and plate reached critical values. There is a limit to the difference of potential existing between electrodes before electrons start spinning around inside the tube.

What we want, then, is a bias which is equal to twice the cut-off value and just enough grid current due to excitation to dip over the fixed bias. In this way we limit the current in the grid of the tube and make it more stable in its operation. Also, the power efficiency is better. The

driver should have plenty of power in reserve, but tapping down on the coupling coil between driver and driven stages is employed, or other means of reducing the excitation, so that a minimum of grid current will flow. We want as much plate current to flow in the tube as possible—up to the safe limit of operation. By tapping down on the plate coil of the tube, and reducing coupling to the load, we can use a higher plate voltage and get lower power output—output sufficiently low so that the tube does not overheat, or we can use tight coupling between the plate circuit and the succeeding amplifier and lower plate voltage—for as the load current goes up, the plate current of the driver increases. If the load is of high impedance, we want a high tap position on the coil and a lower plate voltage. An alternate method would be to lower filament emission by operating the tube with reduced filament voltage. However, this seems to be in little favor in practice, as it has been more or less proved that the filament should be maintained at constant voltage for maximum tube life and at the voltage recommended by the tube designer.

In Fig. 1, the grid-leak current for the Class C buffer is indicated by meter A2. The plate tank condenser Cp2 is always tuned, of course, for minimum plate current. However, in some cases a further adjustment is provided in the form of a tap for the plate coil, the plate connection of the tube being to the tap on Lp2, so that more or less—as required—impedance may be obtained. An impedance match between the plate-cathode of the tube and the tank circuit is desired for maximum transfer of energy.

The outstanding characteristic of a properly adjusted Class C amplifier is that the plate current is proportional to the applied plate voltage and varies linearly with that voltage, just as a resistance would behave. This is why the modulated stage of a transmitter is always Class C. The plate voltage of such a stage is swung by the modulating voltage, which is the same value as the D.C. resting voltage, from zero to twice the unmodulated or resting potential. Since power varies as the square of the voltage if resistance is held constant, the power on peaks will be four times the unmodulated power. The average power with fixed tone modulation will be 1.5 times the unmodulated.

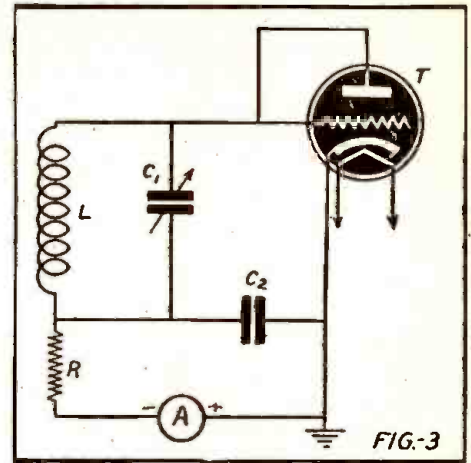

CLASS B LINEAR AMPLIFIERS FOR R.F.

In a receiver, a Class A amplifier functions as a linear R.F. gain device. In transmitters, a linear amplifier is a modified Class C system. That is, the bias is adjusted to slightly less than cut-off. The usual definition of a class B amplifier is that the tube is so operated that half-wave pulses result in the output and bias is equal to cut-off or  $E_p/\mu$ . The linearity of the amplifier is also largely dependent (in addition to correct bias) upon the choice and use of a high load impedance. This impedance bears a favorable ratio to the average value of plate impedance of the tube. The bias for such a stage is critical and must not be obtained from a grid leak but rather from a battery or grid power supply. The bias must remain rock steady for any degree of modulation or any variation in excitation voltage of the grid. The grid current drawn by the Class B amplifier varies appreciably during the operation cycle, putting a variable load on the driver which must, therefore, be adjusted for maximum stability. This means a sufficient reserve power in the driver is required and frequently the Class B amplifier grid tank will be loaded with shunt resistance so as to stabilize the power.

Loose coupling between driver and amplifier will minimize reaction of the amplifier on the driver. The plate efficiency of the amplifier will be directly proportional to the exciting voltage and in practical

(Continued on following page)

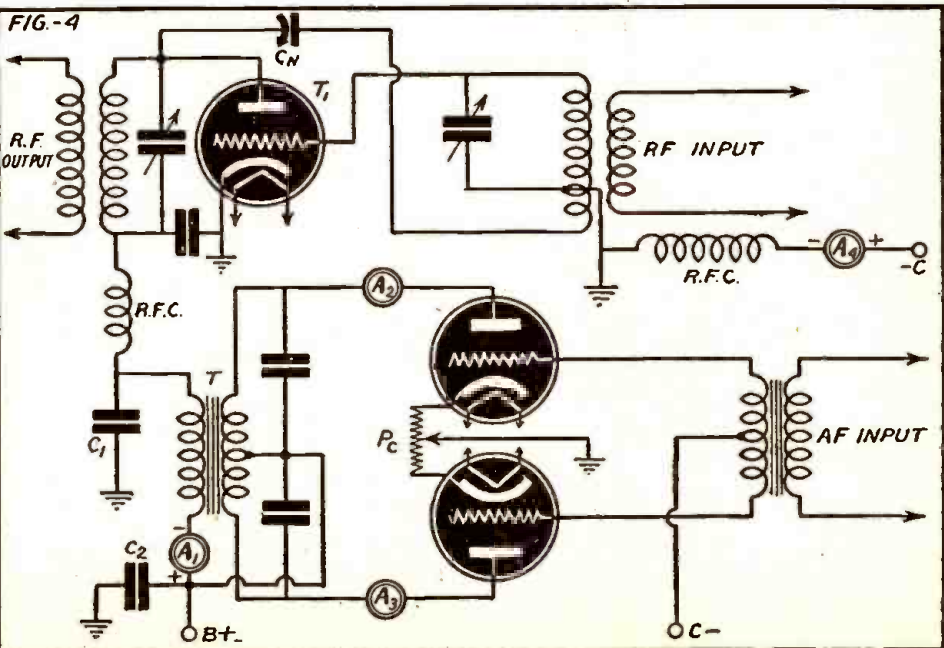
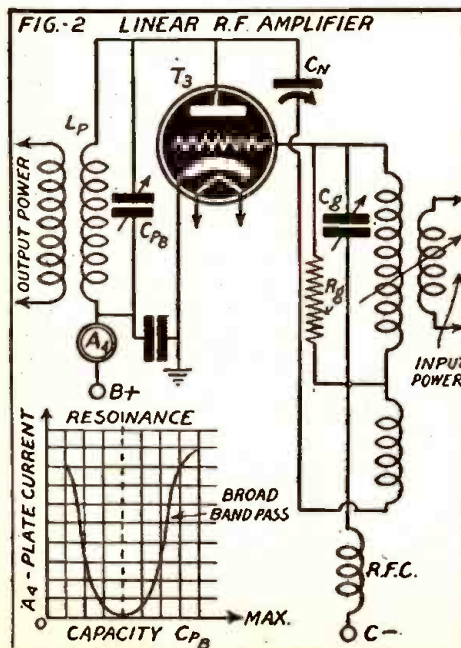

(Continued from previous page)

amplifiers plate efficiency is about 30% with no modulation. The power output is about 1/4th that of the same tube used in Class C. During modulation, the tube efficiency increases as a result of the side-band energy of the modulation frequencies. The D.C. current of the tube remains substantially constant with modulation (average values). The modulation merely superimposes A.C. values that represent no power so far as the D.C. plate supply for the tube is concerned.

For good regulation, a shunt resistance as shown in Fig. 2 is required across the grid circuit of the Class B amplifier. The power in this resistance is approximately 1/5 the output power of the stage. Performance of the amplifier can be checked by using a carrier shift indicator. Negative carrier shift indicates too high an output impedance, as a general rule.

However, in some cases, negative shift may show the effect of too low a bias, excessive excitation or possibly a combination of all the above. A typical circuit, which is quite simple, is shown in Fig. 3. Here, resistor R is the diode detector load and C2 is an R.F. by-pass having little reactance at R.F. but comparatively high audio reactance. Headphones could be cut into the circuit for getting an aural check if required. The moment the modulation goes over 100%, the carrier current evidences a shift and the reading of the meter in Fig. 3 would change, showing a rise in the rectified current. In a properly operating transmitter, with or without modulation the carrier will remain steady. An improperly adjusted linear amplifier might raise or lower the percentage of modulation but in either case would produce distortion.

**INTERPRETING CARRIER SHIFT READINGS**

The D.C. plate current of a Class C plate-modulated amplifier will provide a rough check on the carrier and linearity, but the carrier shift indicator is a valuable auxiliary affording greater precision. If the carrier current drops, the trouble may be poor power-supply regulation, over-excitation and high grid bias as a result of it, improper neutralization, and possibly an unbalanced Class B modulator. In some cases it may mean too loose coupling to the load or an impedance mismatch between the tube and the plate tank, which can be corrected by selecting a different value of L/C ratio or tightening the coupling. The coupling of the plate circuit to the load should be increased and the grid excitation should be brought up to correct level with the carrier unmodulated. Modulation should then be applied and the test for carrier shift with modulation applied should be repeated. The regulation of the power-supply system can be determined by watching the plate voltmeter.

Should the carrier shift indicator show an increased rectified current before the 100% modulation condition is reached, the trouble probably is due to a low impedance plate circuit caused by too tight coupling between plate and following stage. The coupling may be loosened to correct the condition and the modulation test repeated. Where the coupling can not readily be changed, the inductance/capacity ratio in the plate tank may be altered by changing the inductive load, shorting out turns or using a tap, the decrease in the inductance being taken as lowered impedance and the increase in capacity being affected by re-setting of the tuning condenser; but in any case the plate tank is made, of course, resonant to the operating frequency of the transmitter.

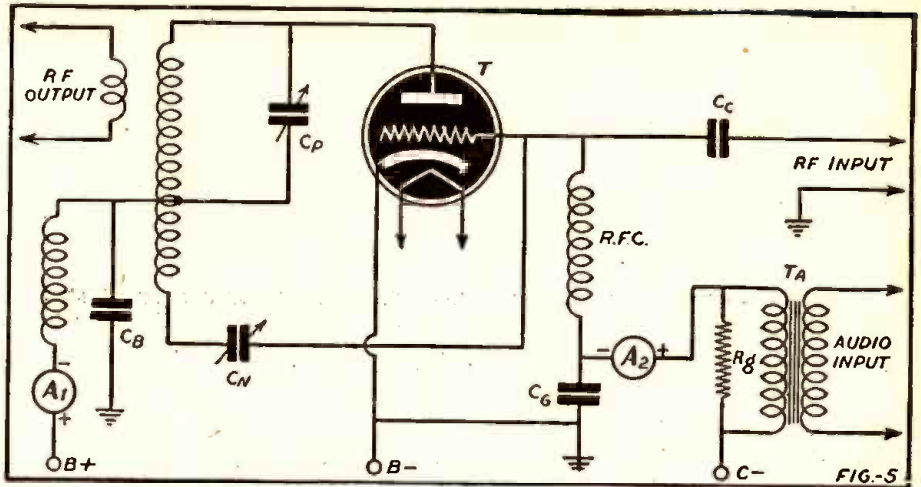

**BALANCED CLASS B MODULATORS**

In Fig. 4, we have the circuit of a typical Class C stage plate modulated by a pair of audio power tubes operated in Class B. Primarily, we want as low a harmonic content in the output of the modulator as it is possible to achieve, and as little frequency shift as possible. In many transmitters this would mean a separate power supply for the Class B system, since the plate current varies greatly during the cycle and power-supply regulation must be unusually good.

The properly adjusted Class C stage will behave like a resistance of constant value and its average plate current indicated by a D.C. meter will be steady since the plate current variation will occur at perhaps one million times a second for the carrier, and with modulation the plate current may vary periodically at the high rate of 40 to 15,000 cycles per second, fluctuations which the meter does not follow if the power supply regulation is perfect and the stage is not over-modulated.

In the Class B modulator, two tubes are used in push-push, which must be distinguished from push-pull. When the tubes are operated as linear amplifiers, and the bias is slightly less than the value required for plate-current cut-off, the distortion is quite low provided both tubes are practically identical in their characteristics and the plate currents indicated by the meters A2 and A3 are alike. A 10% difference in the readings would mean second-harmonic distortion of about 5%. Usually, some means of balancing the modulator currents is provided so that distortion will be minimized and modulation will be symmetrical in its pattern or wave form. The power output of such a modulator is proportional to the square of the grid excitation voltage and the plate current will change during the normal operation of the amplifier, necessitating good power-supply regulation for minimum distortion. This variable grid current and plate current causes a variable load to be placed on the driver circuit, which, also, must have low resistance and good regulation as well as adequate reserve power.

The proper load resistance, plate to plate, is:

$$R_L = 4 \frac{E_b - E_{min}}{I_{max}}$$

and the proper operation, from a practical standpoint, occurs when the minimum plate potential  $E_{min}$  is considerably larger than the maximum positive grid potential  $E_{max}$ . In the formula just given, the value  $E_b$  is the plate supply voltage,  $I_{max}$  is the peak plate current of each individual tube and  $E_{min}$  is the lowest value of instantaneous plate potential reached during the cycle.

The plate efficiency is given by: plate efficiency equals

$$\left( \frac{\pi}{4} \right) \left( 1 - \frac{E_{min}}{E_b} \right)$$

The maximum possible efficiency is the ratio  $\pi/4$  or 78.5% and the proximity of this value to the actual efficiency, as the theoretical maximum is approached, is governed by the relation,  $E_{min}/E_b$ .

**CLASS B DISTORTION**

Tubes operated as Class B amplifiers, in what appears to be push-pull but is really Class B push-push, will not provide the low harmonic output obtained with the same arrangement used for Class A or Class AB. In a Class B system, there is no cancellation of odd or even harmonics. The harmonics can be kept down, however, by using tubes which possess substantially straight  $E_p-I_p$  characteristics. The choice of load also has much to do with the linearity, linearity being greater with load impedances that are high compared with the average, effective plate resistance at the sacrifice of some of the power output over the linear region of tube operation.

**GRID-CIRCUIT MODULATION**

Many modern transmitters employ grid-circuit modulation. A typical basic circuit is shown in Fig. 5. For broadcast or high-fidelity work, the tube T is operated as a Class B linear stage and the audio exciting voltage on modulation peaks just swings the grid to zero potential. To keep the distortion as low as possible, it is also desirable to operate with a load impedance such that the minimum plate potential is small compared with the plate supply voltage. This dictates the use of a tube having a low amplification factor. However, the power output obtainable on modulation peaks will fail to bring the plate dissipation of the tube up to rated value and, in order to obtain high linearity, a sacrifice in power output must be the rule.

For police radio, aircraft and straight communications, the grid-modulated stage may be run as Class C and the distortion held at a minimum by providing a driver source capable of good regulation and having low resistance. The grid bias may be slightly less than twice cut-off in order to clear up distortion. The linear amplifier, for broadcast work, may have a bias slightly less than the value required for complete plate-current cut-off.

The first step in adjusting such an amplifier is to obtain the bias conditions for the type of operation desired, whether

(Continued on page 688)



# Static in Car Radios Traced to Tire Friction

*The disclosure that car-radio static is caused by tire friction rather than by the car's ignition system is of tremendous importance to the radio Serviceman. The engineers who conducted these tests not only were able to prove conclusively the source of this type of interference but were able also to find a simple remedy for minimizing frictional static.*

**S**TATIC in automobile radios has been traced directly to friction from tires, according to a report by J. W. Liska and E. E. Hanson of the Firestone Tire and Rubber Company in "Industrial and Engineering Chemistry," journal of the American Chemical Society. The type of pavement and weather conditions are contributing factors controlling the amount of static, the technologists found.

Concrete pavement causes less static trouble than asphalt, while static increases on either type of pavement if the surface is hot and dry. For this reason there may be less static present during early morning driving than later in the day. Grease film in the front wheel bearings was also identified as a cause of increasing static.

Tires with low electric resistivity and small coil springs placed between the front wheel and the front axle eliminate much of the static annoyance, the tests revealed.

Accumulation of static electric charges on a moving car became a problem for rubber technologists with the popularization of the car radio, the report points out. "At first difficulty was experienced mainly with radios in passenger cars. In some cases when the auto was stationary and the motor running, the program reception was clear and uninterrupted; but when the car was set in motion and driven for some distance, reception was seriously impaired by loud, intermittent static noises.

"Later, there were reports of toll-bridge collectors receiving severe electrical shocks on touching any part of a car which had just pulled to a stop after a sustained drive. Similar phenomena reportedly took place when motorcycle police touched cars they had pursued and stopped. Recently, passengers on commercial busses, especially on those operating in hot, dry regions, have experienced shocks on entering or leaving."

Tests with cars reporting radio difficulties proved that the tires were at fault. No static was heard on the radio while the car was stationary, whether the motor was idled or raced. There was no static if the car was driven slowly, but as the speed was increased over forty miles per hour the static increased. After the car was driven for several miles at more than forty miles an hour speed, the motor was turned off and the car coasted down hill, but the static did not decrease until the car speed was reduced. There was momentary reduction of static with a sudden, short-duration application of brakes. The same car was tested again with a different set of tires, and much less static resulted.

"These tests proved conclusively that the static developed was caused principally by the tires and was in no appreciable degree connected with the ignition system of the car or the airstream around it," the technologists declare. "The tests provided clues to the source of static discharge and led to

a rather simple and effective method of reducing this type of static trouble.

"The results indicated that when the wheels were connected electrically through the brake bands to the frame of the car, the static discharge diminished considerably. After the brakes were released, if the car still had sufficient speed, the static discharge would build up to annoying proportions.

"There is an explanation for this. Charge separation occurs in the tire-pavement contact area by the familiar frictional process. This is possible because the tire tread and usually the road are poor electrical conductors. However, a tire is not a perfect insulator. Therefore, the charges on the tread leak over and through the tire side walls to the wheel. A leakage also occurs from the wheel to the pavement contact area. If we assume that the car moves at a constant velocity over a uniform pavement, an equilibrium will eventually be reached between the charge leakages from the treads to the wheels and from the wheels to the pavement contact areas.

"However, since pavement surfaces usually do not possess uniform electrical properties, the rate of charge generation at the tire treads of a moving car will fluctuate over wide limits, and the equilibrium voltage is frequently interrupted.

"Because the rear wheels are connected electrically to the frame of the car, they possess a much larger capacitance than the front wheels which are partly insulated from the frame by grease films in the bearings. It is therefore likely that large enough differences of potential often exist across the grease films in the front wheel bearings to cause electrical breakdown.

"Another, and possibly more important, cause for radio static from tires is the charging of the car by induction. The negatively charged tire treads repel electrons from the fenders and other nearby regions to the more remote parts of the car and, in general, lower its potential with respect to ground. Whenever a fluctuation in the tread potential occurs, momentary electrical displacement currents also occur in the car. Any insulation between various parts of the car, such as the grease film in the front wheel bearings, will therefore be conducive to spark-over. This process probably is responsible for the major part of tire static interference with radio reception.

"This theory is substantiated by the fact that, if the axle and the wheel are maintained at the same potential by small coil springs placed in compression between

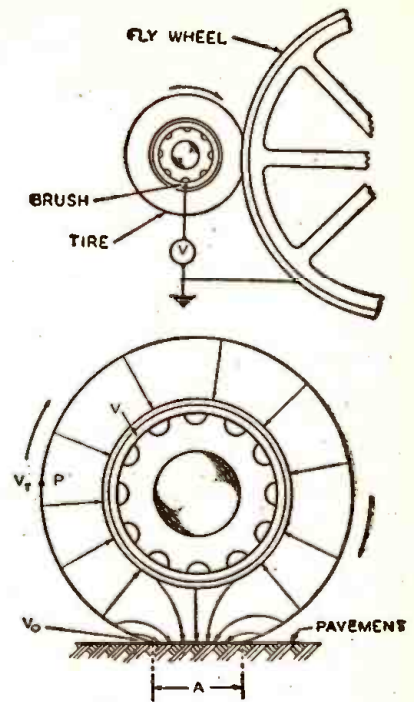

These sketches illustrate the method used by Firestone engineers in measuring the potential difference between tire rim and pavement.

the metal hub of the front wheel and the front axle, the greatest part of the static trouble is eliminated. What little remains is not troublesome and can probably be ascribed to a similar mechanism between other fairly well insulated parts of the car."

Other road tests demonstrated that a definite difference in the static generation properties of various sets of tires exists, so that a radio may function more clearly with some tires than with others. "In comparative tests an attempt was made to measure the potential differences developed between the car body and the ground. The car potential was found to be greatly affected by atmospheric conditions and by the type of pavement. On a smooth asphalt pavement much more static was observed than on a concrete pavement.

"The car potential for a given pavement increased with decreasing humidity. When the car was driven at thirty miles per hour on a concrete pavement the potential was usually below 1,000 volts for a humidity over 50 per cent; but under the same conditions, on an asphalt pavement, the potential might be as high as 3,000 or 5,000 volts.

"It was also found that the potentials generated on the car were lowest in the morning and gradually increased during the day, even when no appreciable changes in humidity and air temperature occurred. This increase in static production was prob-

(Continued on page 691)

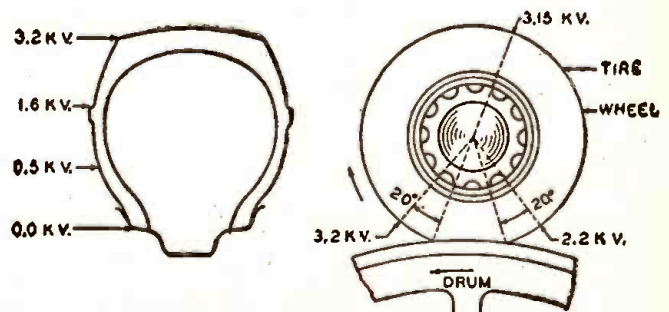

Potentials found along different sections of tires in the study of automobile and airplane shock hazards. Sketches reproduced by courtesy of the American Chemical Society.

# MAKING A CODE-TEACHING MACHINE

B. BERNSTEIN

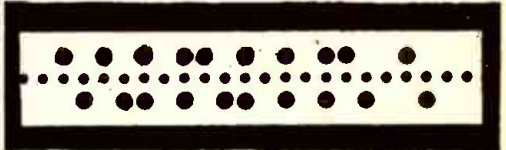
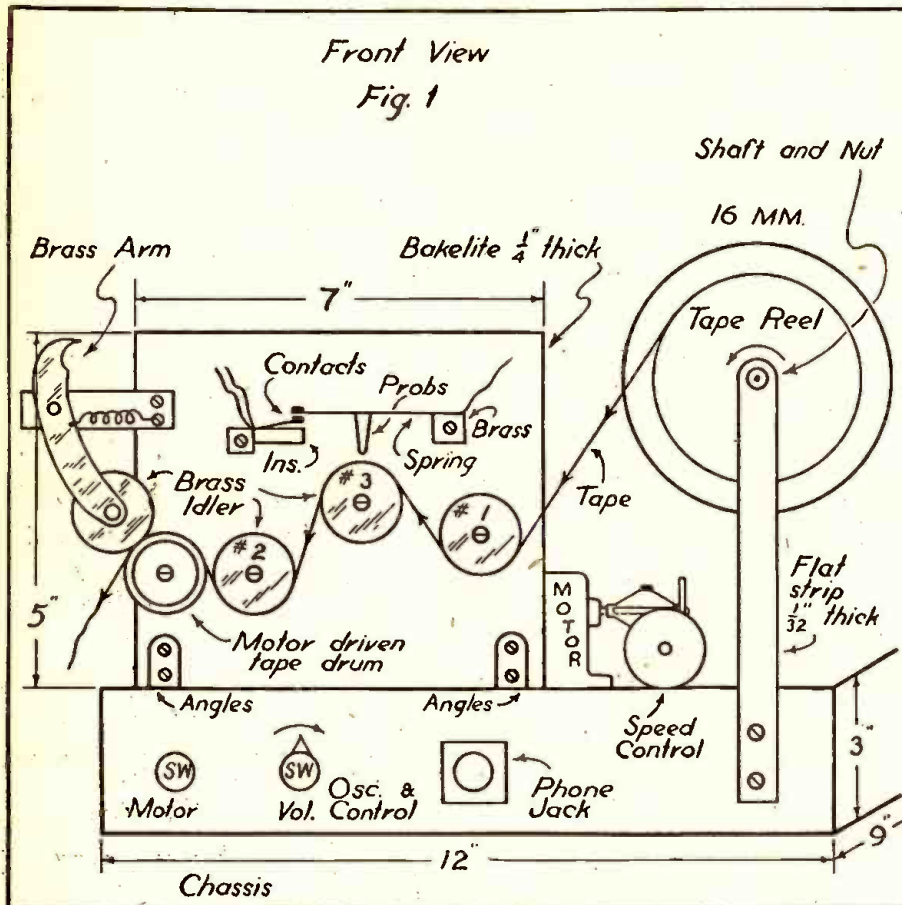

This is the actual size of the tape described in the article.

The increased interest in code learning, brought about by our entrance into the war, suggests that students, and possibly instructors would find a code-teaching machine useful not only for basic instruction but also as a means of increasing speed of copying.

HERE is a radio code-teaching machine which I constructed from odd parts which may still be generally available. The device operates from the power line, 110 volts A.C. or D.C., and is entirely complete and ready to run at any time. It sends radio code at from 3 to 48 words a minute, depending on the governor adjustment. The whole unit is mounted on a radio chassis 12 inches long by 9 inches wide and 3 inches deep. It has binding posts for a hand key whenever it is desired to send by hand. The chassis arrangement is shown in Fig. 1.

## UNIT INCLUDES TUBE OSCILLATOR

The machine consists of the following main items: An audio oscillator consisting of a type 76 tube and a 25Z5 rectifier, half of which provides current to operate the oscillator and other half to operate the keying device. The pitch is varied by a variable resistance for the grid leak, from 500,000 ohms to 2 megs.

An A.C.-D.C. motor connected in series with a resistance of 250 ohms gives some variation of speed, but since this arrangement seriously affects the pulling power at low speeds a governor is mounted on one shaft end and a drive pulley on the other end (see Fig. 3). The pulley is a small rubber tire mounted on a small brass pulley to drive the friction disc which, in turn, drives the gears in the reduction box. The ratio is 44 turns of the motor shaft for 1 turn of the tape drum.

The slowest turning shaft projecting from the gear box has the tape drum mounted on it. This consists of a brass sleeve 1 inch in diameter and  $1\frac{1}{2}$  inches long, drilled for a  $\frac{1}{4}$  inch shaft. It has a set screw, and a length of rubber tubing is forced over it for better tape pulling. An idler roller supported on an arm has a spring to keep the idler tension against the tape drum. The tape runs between these two.

## GOVERNOR REGULATES SPEED

The governor is of the spring and weight (centrifugal) type, in which the small weights on the spring spread out when the armature turns faster. An arm tipped with a small piece of leather rides against the disc on the governor. The speed is regulated by moving this arm towards or away from the governor disc. By arranging a

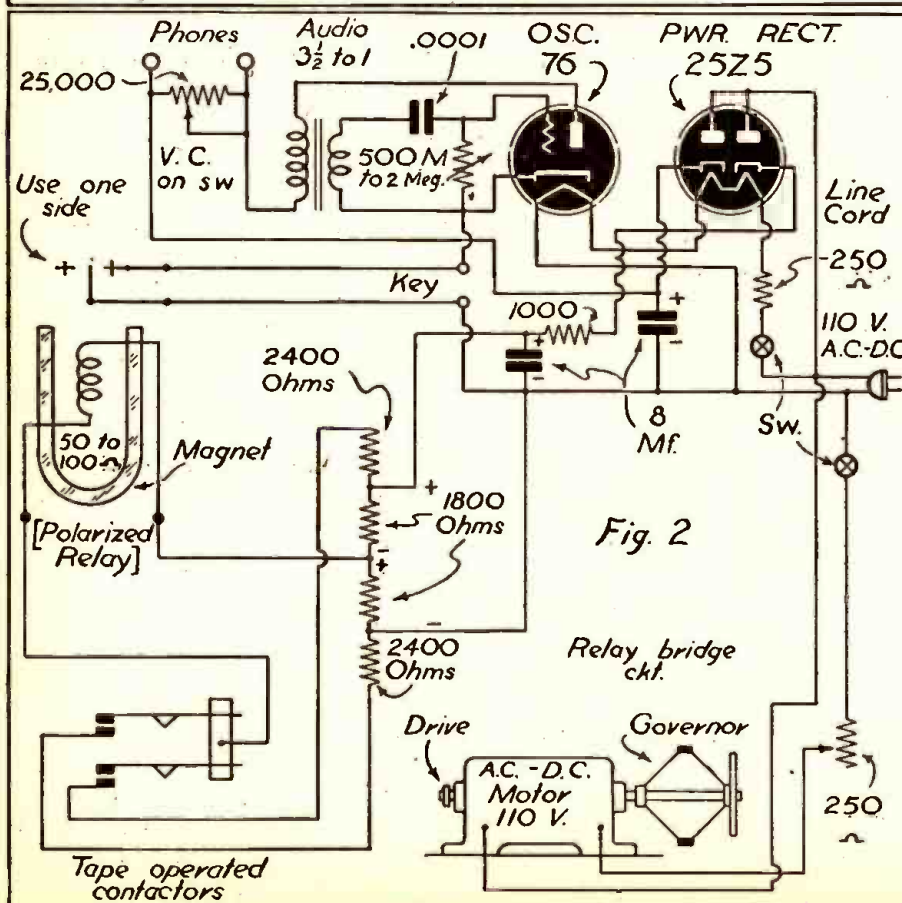

fine thread adjusting rod against this arm, fine and smooth variations of speed are obtained. In the device described the gears were obtained from an old clock, the governor came from an old phonograph motor.

A polarized relay with a coil winding between 50 and 100 ohms can either be purchased or made. As the contacts do not break more than 10 milliamperes at most they can be very small. Any type of polar relay can be used. The constructor may be able to obtain one from an old telephone board.

**TAPE PUT ON 16MM FILM REEL**

A roll of perforated tape on a 16mm film reel is mounted on an upright, as shown in Fig. 1. This reel is free to revolve. The tape is fed through the keying device, which consists of three tape guides, two flat springs with probes soldered to their centers, contacts at their free ends, with the opposite ends held rigidly together. The ends with the contacts have stationary contacts opposite them on an insulating block. These contacts when they make, allow current to flow into the relay. The current is either of a positive or negative polarity, thus swinging the relay armature one way or the other.

The probes in the center of the springs fall into the holes in the tape upon which they ride as the tape is slowly pulled under them by the tape-pulling drum to the left of the panel. This causes the springs either to fall into a hole or ride on top of the tape. This up and down movement allows the contacts on the end to make or break. The movement is not more than 1/32 to 1/16 of an inch. The probes are of hardened steel, and can be either soldered, welded or riveted to the springs. The springs are 2 1/2 inches long and 1/4 inch wide. The clock spring straightened out.

The contacts are small pieces of silver soldered to ends and then filed smooth and round. The springs are adjusted so that the one in front is ahead of the other by the distance of 1/2 tape hole. That is, the front probe falls into a hole first and as the tape progresses, the one behind it follows into a hole on its own side of the tape, 1/2 width of a hole later.

**ELECTRICAL ACTION EXPLAINED**

The electrical action works as follows: When the front probe falls into a hole, it allows the contacts on its end to "make," thus exciting the relay and moving its armature over towards one side. As the tape continues its travel, the probe is moved up, disengaging the contacts; but the relay stays on the side thrown because of polarization of the magnet (all polar relays have magnets, either an electromagnet or a horseshoe type). When the probe on the other spring falls into a hole in the tape, this allows its spring to make contact, causing the relay to move the armature from the contact it has been lying against towards the opposite contact. If the character of the signal is a dot, the relay armature will stay against the keying contacts only for a small interval of time; if a dash, the relay will stay against the keying side three times as long.

**ONE SIDE OF RELAY USED**

Only one side of the relay is used for keying the oscillator, the other side is a stop. The relay armature should be light and free so it can move rapidly from one contact towards the other. There are no springs on the relay and the armature is adjusted so that it is in neutral position; that is, it should stay against one contact or the other when moved over by the finger.

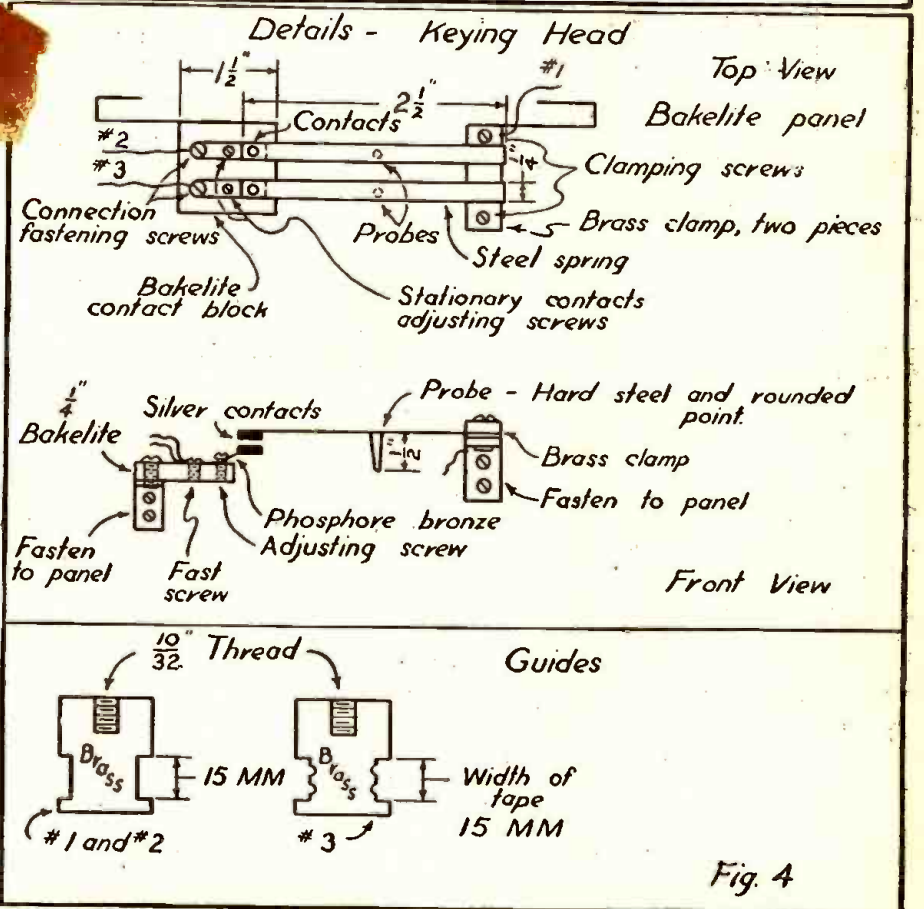
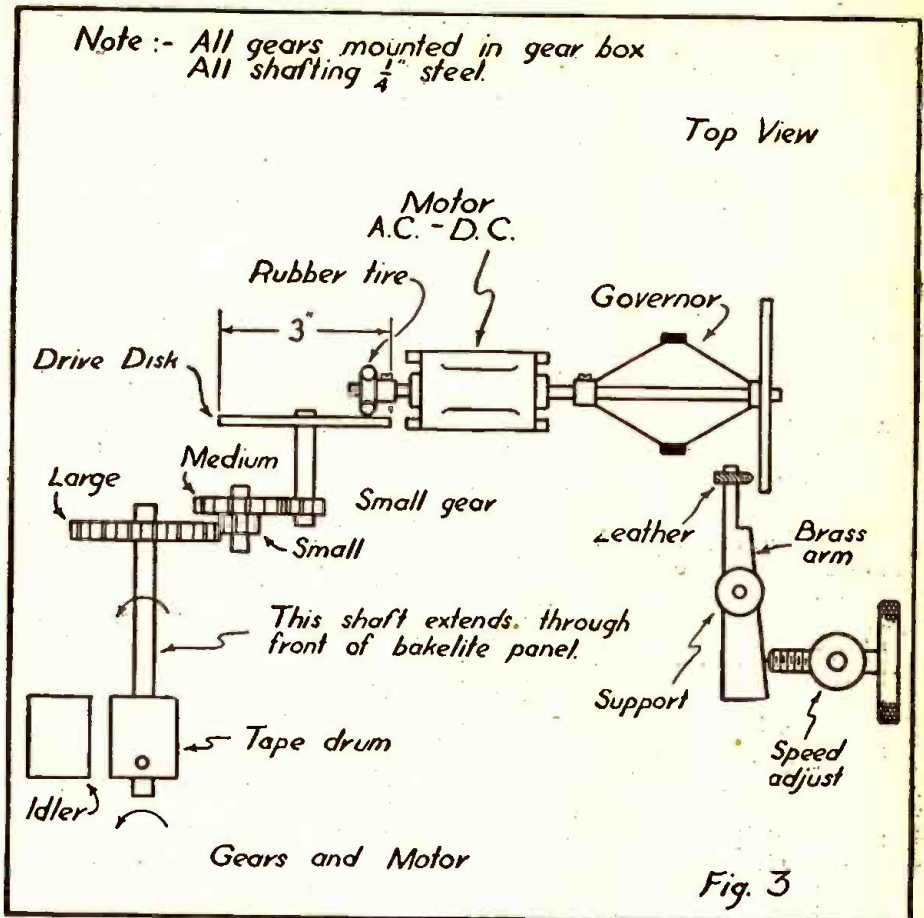

The tape may be obtained, already punched, from most telegraph companies, the weather bureau or other places using radio code transmission, such as press associations. The center small holes in the tape are not used.

The probes can be made of hardened steel or may be drill ends. They should be pointed so that they fall into the tape holes for a distance of 1/32nd of an inch. The ends should be rounded to avoid tearing the little connecting necks between the holes.

**BUY YOUR  
Echophone  
COMMERCIAL  
"The Ears of the World"  
COMMUNICATIONS RECEIVER  
NOW!**

Everyone should have a good, full frequency coverage receiver—and these Echophone Commercial receivers are excellent for every purpose!

For the home—receive all local broadcast stations with fine quality—tune in foreign short wave stations for fun and news—copy press stations for code practice—in the event of an Air Raid alert, local stations shut down. Tune your Echophone Commercial to a S.W. broadcast station in a different part of the country and keep informed.

For the Boys in the Service—receive your home programs, no matter in what distant place you are based. Your sturdy Echophone Commercial in its compact metal cabinet will take lots of hard knocks and still pull 'em in! AC-DC, can work on practically any current.

**IMMEDIATE DELIVERY!**

Same day shipment to any part of the U.S.A., its Territories and Possessions, or to any member of our armed forces.

**MODEL EC-1  
\$24.50**

A six-tube, AC-DC, communications receiver whose "hop" will amaze you! 550 Kc to 30 Mc in three bands, electrical bandspread, BFO, self-contained dynamic speaker—Safety headphone jack, etc. A "knock out value" at only \$24.50, complete!



**MODEL EC-2**



Here's the new and improved version of this popular set. Now with an external speaker (just like EC-3). Automatic noise limiter, pre-selection on all bands, calibrated bandspread, AC-DC, safety headphone jack, 8 tubes, 545 to 30.5 Mc. Bigger value than ever at only \$42.50, complete with speaker in matching cabinet.

**MODEL EC-3**



10 tubes, 545 Kc to 30.5 Mc. Pre-selection and electrical bandspread on all bands, calibrated Amateur bandspread, variable selectivity crystal filter, automatic noise limiter, two IF stages, dynamic speaker in matching cabinet, AC-DC, safety phone jack, etc. You'll like the "top-notch" performance of this swell communications receiver! Get yours today for only \$59.50, complete with speaker.

**ORDER TODAY!! Before they are all taken!**

**HARRISON  
RADIO COMPANY  
12 WEST BROADWAY NEW YORK CITY**

**26 FM Commercials on Regular Schedule**

Twenty-six commercial FM stations are now operating on regular daily schedules. None of them transmits for less than six hours daily—three hours before and three after 6 p.m. is the minimum operation permitted by the F.C.C. The longest program day for any of these stations is 24 hours a day for seven days a week.

It is very likely that three or four additional FM transmitters will be added to this list before long. The data given includes the channel on which the station operates and the assigned coverage area in square miles.

- K45LA—Los Angeles, Calif.  
Don Lee Broadcasting System, 5515 Melrose Ave., Hollywood. 44.5 mc., 6,944 sq. miles.
- W53H—Hartford, Conn.  
Travelers Broadcasting Service Corp., 26 Grove Street, Hartford. 45.3 mc., 6,100 sq. miles.
- W65H—Hartford, Conn.  
WDR, Inc., 750 Main Street, Hartford. 46.5 mc., 6,100 sq. miles.
- W51C—Chicago, Ill.  
Zenith Radio Corporation, 6001 Dickens Ave., Chicago. 45.1 mc., 10,800 sq. miles.
- W59C—Chicago, Ill.  
WGN, Inc., 441 North Michigan Avenue, Chicago. 45.9 mc., 10,800 sq. miles.
- W67C—Chicago, Ill.  
Columbia Broadcasting System, 410 North Michigan Ave., Chicago. 46.7 mc., 10,800 sq. miles.
- W45V—Evansville, Ind.  
Evansville On the Air, Inc., 519 Vine Street, Evansville. 44.5 mc., 8,397 sq. miles.
- W45BR—Baton Rouge, La.  
Baton Rouge Broadcasting Co., 444 Florida Street, Baton Rouge. 44.5 mc., 8,100 sq. miles.
- W43B—Boston, Mass.  
The Yankee Network, 21 Brookline Ave., Boston. 44.3 mc., 18,647 sq. miles.
- W67B—Boston, Mass.  
Westinghouse Radio Stations, Inc., Hotel Bradford, Boston. 46.7 mc., 6,700 sq. miles.
- W45D—Detroit, Mich.  
Evening News Association, 4500 Penobscot Building, Detroit. 44.5 mc., 6,820 sq. miles.
- W49D—Detroit, Mich.  
John Lord Booth, Eaton Tower, Detroit. 44.9 mc., 6,800 sq. miles.
- W39B—Mt. Washington, N. Hamp.  
The Yankee Network, 21 Brookline Ave., Boston. 43.9 mc., 31,000 sq. miles.
- W47NY—New York City, N. Y.  
Muzak Radio Broadcasting Station, Inc., 70 Pine Street, New York City. 44.7 mc., 8,500 sq. miles.
- W67NY—New York, N. Y.  
Columbia Broadcasting System, 485 Madison Ave., New York City. 46.7 mc., 8,500 sq. miles.
- W71NY—New York, N. Y.  
Bamberger Broadcasting Service, 1440 Broadway, New York City. 47.1 mc., 8,500 sq. miles.
- W47A—Schenectady, N. Y.  
Capitol Broadcasting Co., 408 State Street, Schenectady. 44.7 mc., 6,589 sq. miles.
- W51R—Rochester, N. Y.  
Stromberg-Carlson Telephone Mfg. Co., 111 East Avenue, Rochester. 45.1 mc., 3,200 sq. miles.
- W45CM—Columbus, Ohio.  
WBNS, Inc., 33 North High Street, Columbus. 44.5 mc., 12,400 sq. miles.

- W49PH—Philadelphia, Pa.  
Pennsylvania Broadcasting Company, 35 South 9th Street, Philadelphia. 44.9 mc., 9,300 sq. miles.
  - W53PH—Philadelphia, Pa.  
WFIL Broadcasting Corp., Widener Building, Philadelphia. 45.3 mc., 9,300 sq. miles.
  - W69PH—Philadelphia, Pa.  
WCAU Broadcasting Co., 1622 Chestnut Street, Philadelphia. 46.9 mc., 9,300 sq. miles.
  - W47P—Pittsburgh, Pa.  
Walker-Downing Radio Corp., Hotel Keystone, Pittsburgh. 44.7 mc., 8,400 sq. miles.
  - W75P—Pittsburgh, Pa.  
Westinghouse Radio Stations, Inc., Grant Building, Pittsburgh. 47.5 mc., 8,400 sq. miles.
  - W47NV—Nashville, Tenn.  
National Life & Accident Insurance Co., Seventh Ave. and Union St., Nashville. 44.7 mc., 16,000 sq. miles.
  - W55M—Milwaukee, Wis.  
The Journal Company, 333 West State Street, Milwaukee. 45.5 mc., 8,540 sq. miles.
- The relative sizes of service areas may be explained as follows: A station with an assigned coverage of 3,847 square miles has a range of approximately 35 miles. This is much less than the average for FM commercial outlets. An area of 5,024 square miles figures out at 40 miles; 7,850 square miles means a range of 50 miles; 11,304 is a 60-mile range; 15,386, a 70-mile range, and 31,400, a 100-mile range.
- Besides the commercial stations, there are still a few experimental transmitters regularly on the air. These have not been assigned any specific coverage and, in most cases, provide but limited service. All are building, or hope to build, commercial installations. The experimental FM stations operating last month were these:
- W1XTG—Worcester, Mass.  
Worcester Telegram Publishers Co., Inc., 18-20 Franklin Street, Worcester. 43.4 mc.
  - W1XSN—Springfield, Mass.  
Westinghouse Radio Stations, Inc., Hotel Kimball, Springfield. 42.6 mc.
  - W2XOY—Schenectady, N. Y.  
General Electric Co., One River Road, Schenectady. 43.2 mc.
  - W2XMN—New York (Alpine, N. J.).  
E. H. Armstrong, Alpine, N. J. 42.8 mc.
  - W2XQR—New York, N. Y.  
Interstate Broadcasting Company, 730 Fifth Avenue, New York. 45.9 mc.
  - W2XWG—New York, N. Y.  
National Broadcasting Company, 30 Rockefeller Plaza, New York. 45.1 mc.
  - W3XO—Washington, D. C.  
Jansky & Bailey, National Press Building, Washington. 43.2 mc.
  - W8XAD—Rochester, N. Y.  
WHEC, Inc., 40 Franklin Street, Rochester. 42.6 mc.
  - W9XER—Kansas City, Mo.  
Midland Broadcasting Company, Pickwick Hotel, Kansas City. 46.5 mc.
  - W9XYH—Superior, Wis.  
Head of the Lakes Broadcasting Company, WEBC Building, Superior. 43.0 mc.
- Besides these stations, a number of non-commercial educational FM transmitters have been authorized by the Federal Communications Commission. At least two—WBOE, in Cleveland, Ohio, and KALW, at San Francisco—are in regular daily operation.

# MELTING SLEET FROM FM DIPOLE

KENNETH GARDNER\*

**T**HE formation of sleet on an antenna having elements of comparatively large diameter, such as we have at W51R, is not serious with respect to the electrical characteristics. There are mechanical hazards, however, because wind resistance and the resulting strain on the structure increase directly with the diameter and as the square of the wind velocity.

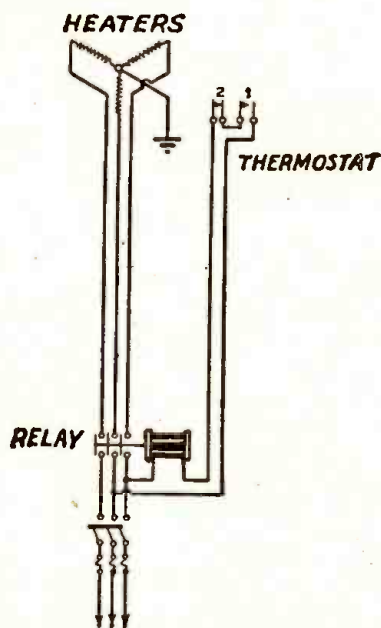

Fig. 1—Sketch showing wiring of essential elements of sleet remover.

Large icicles are a danger to life and property, too, and must be prevented from forming, particularly when the antenna is mounted on a city building, since falling ice endangers pedestrians, automobiles, and windows.

Sleet and ice form on objects whenever the temperature of the surrounding air is between 28° and 32° Fahrenheit. In other words, if the temperature is above 32°, the precipitation is rain. If the temperature falls below 28°, it is dry snow.

Therefore, it is only necessary to consider this narrow, but very dangerous, temperature range.

W51R's 2-bay turnstile has eight elements, as will be seen in Fig. 2. We built into each element a 4-ft. G.E. Calrod heater unit. The current is turned on to these units when the temperature is within the sleet-forming range in the following manner:

Two thermostats are mounted on the mast just below the turnstile. Free air circulation is provided around them. They are connected to an Allen Bradley relay, as shown in the sketch, in the circuit of the 3-phase, 208-volt supply. (See Fig. 1).

Both thermostats No. 1 and No. 2 must be closed to apply current to the relay. When either thermostat is open, no power reaches the heaters. Thermostat No. 1 closes when the temperature falls below 32°. No. 2 opens when the temperature falls below 28°.

During the past winter, there were several sleet and ice periods in Rochester, but at no time did ice form on the antenna. Pe-

culiarly enough, in this locality sleet forms only when storms arrive from an easterly direction.

This suggests that we might use a third control, connected through a wind vane, so that the heater circuits could not be completed, even with the temperature between 28° and 32°, unless the wind was coming from the east. Or we might use a relay operated by a humidity-measuring device. Our experience, however, has been that the arrangement we are using is entirely satisfactory.

At a station which is manned 24 hours a day, simple manual control might be relied upon in the hands of a weather-conscious person, particularly one afflicted with responsive joints or muscles!

Other interesting details of our turnstile are shown in the photograph. The coaxial cable coming up the mast will be seen to split at a "T". One element of each doublet is fed from the half-wave loop which swings down from the juncture. The opposite elements are fed 180° out of phase, from the top of the "T". (See Fig. 2).

Junction boxes below each bay are for connections to the heaters. The thermostats are located just below the half-wave loop, near enough to the radiators that they are exposed to the same temperatures as the dipole elements.

The design provides light but rugged construction—a consideration dictated by the fact that this antenna is installed in the business section of Rochester, where we could take no chance with structural failure. All the parts, even to the climbing spikes, were welded. This is the antenna which replaced the vertical radiator originally installed at this FM station.

—FM

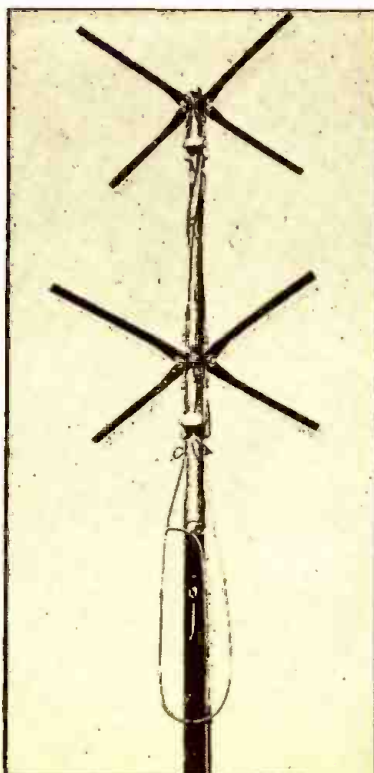

Fig. 2—Photograph of W51R Antenna.

## WEBSTER RECORDER AND PLAYBACK ASSEMBLY



Plays records up to 12" dia. Cuts records up to 10" dia. outside-in at 110 lines per inch. 78 RPM induction type motor employs an internal rim-drive to the turntable. Assembly includes 10" turntable, motor, cutting mechanism, crystal cutting head, 1 1/2 ounce low-pressure crystal pickup. Complete unit with case and Astatic microphone. Wt. 25 lbs. Size 16"x13"x9". For 110V. 60 cycles. Diagram furnished for Amplifier Connection.

NOTE: Should you want to purchase the above units separately, your prices will be as follows:

Webster Recording Unit only	\$19.95
Case	4.95
Microphone	4.45
Cutting Transformer	.75

Positively no C.O.D. shipments made, unless order is accompanied by a deposit of at least 25%. All prices F.O.B. Chicago.

### ARROW RADIO CO.

Div. 542, 900 to 910 Jackson Blvd., Chicago, Illinois

### CODE-TRAINING CLASSES SPONSORED BY ARRL

To provide radio training to America's youth who soon may be eligible for military service, local club groups of the American Radio Relay League are setting up community evening training courses in code and theory in numerous localities throughout the nation.

Clubs in 91 different cities are known to be conducting courses, most of them emphasizing code training. Although handicapped because 15,000 of the most active amateur radio operators are away on military communications duty, the remaining club members are obtaining the use of meeting rooms from local schools, constructing the necessary equipment and acting as instructors. Classes in additional cities are daily being set up, as the League's plan gathers momentum.

The eventual objective in all courses will be the qualification of each student for an amateur Class B license issued by the Federal Communications Commission. In urgent need of men with some communications training to shorten its own necessary schooling, the Army is pleased to see the accomplishment of such training. In fact, along with the Navy it recently asked the F.C.C. to continue amateur operator licensing so that a "ham ticket" could be used for admission to advanced military ratings. In the Signal Corps, for example, no one may enlist unless he holds an amateur or commercial F.C.C. license. In the Navy, ratings of radioman second-class are offered to holders of amateur Class B licenses.

While the preference is for boys in the 16-21 age group, applicants of any age are accepted, since it is realized many trained radio operators will be needed at home in the war effort as well. Women, too, may receive the training; in fact, in several instances classes are composed exclusively of women.

\*Chief Engineer, W51R and WHAM, Rochester, N. Y.

# FM ANTENNAS

The author discusses the subject of high-frequency antennas, tells how to determine the proper lengths of rods or pipes and describes two simple antennas that can be constructed by the experimenter by using the same or similar materials.

SAMUEL M. WERTHEIMER

**F**REQUENCY-MODULATION antennas do not differ materially from other high-frequency antennas from the standpoint of collectors of radiated waves.

A limiting factor in the reception of any ultra-high frequency is the quasi-optical (resembling vision) nature of the radiated signals. The strength of transmitted signal decreases at a very rapid rate to a low level at the end of the line-of-sight distance. To have sufficient signal energy properly to operate a receiver, the most efficient types of antennas and transmission lines must be employed.

The higher the transmitter antenna, the

greater the range of transmission. In reception this is equally true, the higher the receiving antenna, the stronger and clearer the signal. The normal effective service range is usually the line-of-sight distance between transmitter and receiver. This does not mean that the transmitter must be seen in order for its signal to be received. Most buildings or other structures do not offer an effective barrier to the transmission of the ultra-high frequencies.

Most transmitters radiate a horizontal polarized signal, which will best be received on a horizontal polarized antenna. The most effective antenna for the reception of FM

is the horizontal doublet antenna. This type of antenna will give excellent results when properly constructed and installed.

In general, a horizontal polarized signal will be best received on a horizontal dipole with means allowed to permit slight shifts from the horizontal plane. The reason for this is that when the wave is refracted in passing through the varying density of conducting mediums, such as clouds or layers of moisture or dry air alternately, a slight change may occur. To correct this, the antenna should be adjustable from the horizontal position.

## REFLECTOR INCREASES SIGNAL STRENGTH

Increase of signal strength can be effected by placing a reflector behind the antenna, spaced  $\frac{1}{4}$  wave length behind the antenna. For FM the distance is equal to 5' 3". The reflector should be equal to 13 feet overall length and spaced  $\frac{1}{4}$  wave length from the antenna. This reflector has a continuous electrical and physical length, and is not split at the center as is the receiving antenna. The reflector performs two functions—it neutralizes the signal received from the back of the antenna and reinforces the signal of the receiving antenna.

Various types of transmission lines can be used, such as twisted-pair transmission lines, co-axial concentric conductors and open wire transmission lines. For practical purposes, the open wire transmission line is not easily adapted for installation in apartment houses or homes. Twisted-pair transmission lines are the most popular, but, unfortunately, the least efficient for long runs.

The co-axial cable has been found to be the most efficient of all commercial transmission lines available for use with FM receiving antennas. There are two types, the solid dielectric and the beaded. The latter is about 80% air insulated. Both of these types of co-axial cable are efficient and practical. The cost and the availability will naturally determine which type of transmission to use. At the present time, hardly any wire or cable of any description is available. The probability, however, is that some twisted-pair transmission cable can still be obtained. In lieu of this, rubber-covered electric wire or "zip" cord can be used with fairly satisfactory results. The solid type of conductor is to be preferred.

## DETERMINING ANTENNA LENGTH

The frequency band allotted for FM broadcasting is from 42 to 49 megacycles. If reception is desired from a series of stations, a mean average frequency of the stations should determine the proper length of the antenna. For best results, the antenna should be adjusted to the mean average of the local area. For example, for the metropolitan New York area, we have the following stations broadcasting:

W2XMN	42.8 Mcs.
W2XWG	45.1 "
W47NY	44.7 "
W2XQR	45.9 "
W63NY	46.3 "
W71NY	47.1 "

Total 271.9 "

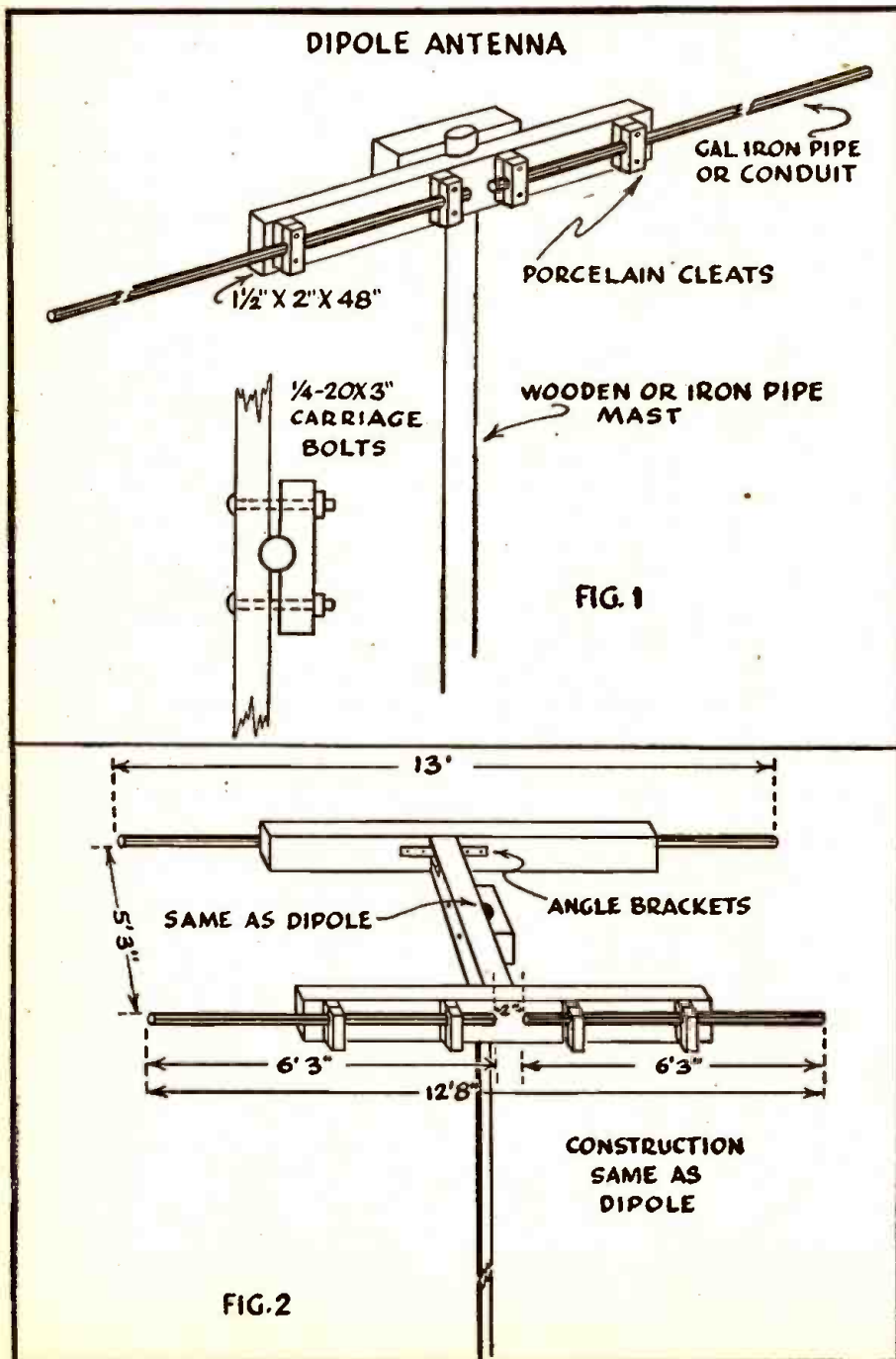

If you divide the number of stations broadcasting (6) into the total of 271.9 Mcs., you will find that 45.3 Mcs. is the mean average for the stations in the New York area. This corresponds to an overall length of 124 inches, or 62 inches for each side of the doublet. However, a dipole doublet antenna, having an overall length of 126 inches, which is the mean average of the allotted band of 42 to 49 Mcs. will be entirely satisfactory for reception of any station in the band.

As stated previously, the antenna should be located as high as possible for clear

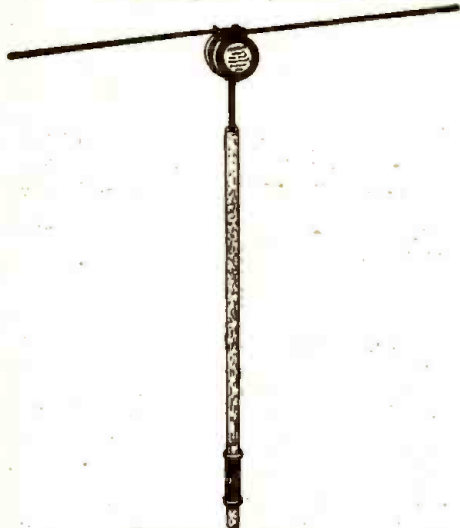

Vertrod V-400 Antenna

pickup of signal strength because of the quasi-optical nature of the waves. A great aid in locating the antenna properly is in the use of a small, portable FM receiver, in which an 0-10 mil. millimeter is connected in the plate circuit of the first I.F. tube. This will determine where the signal is at maximum intensity, i.e., when the meter shows a minimum deflection. After noting the best position for placing the antenna, it is then erected and secured firmly. Other considerations must be kept in mind when locating the antenna, such as the possibility of interference and man-made noises. The antenna should be kept as far as possible from electric trolley wires, auto ignition and other electrical disturbances such as neon signs, elevators and electrical switching devices.

The transmission line should be carefully placed so that it is not exposed to man-made interference. When entering a wall, it should not be broken, but threaded through an entering porcelain tube. The cable should be carefully and firmly secured by using insulated screw eyes. This will prevent the abrasive action of the wall on the insulation of the cable.

**HOW TO CONSTRUCT AN ANTENNA**

For those who want to construct their own antenna, galvanized iron pipe or elec-

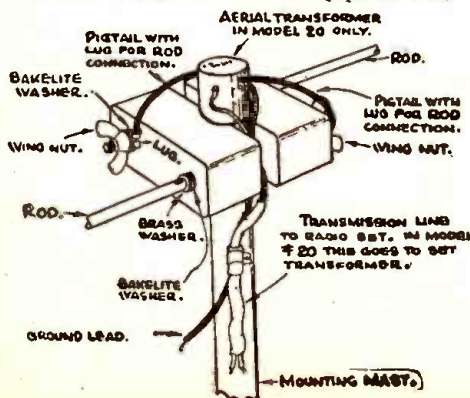

Airraider Antenna.

trical conduit can be satisfactorily used with very little loss of signal strength. Two 6' 3" lengths of pipe are secured to a 1½" x 2" cross arm, with the use of eight heavy porcelain wiring cleats. See Fig. 1. The transmission cable is attached to the inside ends of the rods by soldering. Clean the soldered joint carefully and cover with a waterproof paint in order to prevent corrosion. Then tape over carefully and continue the taping to the point where the transmission cable is parted in the center. At this point, seal up the end of the transmission cable to prevent the rain from leaking in and destroying the insulation. The transmission line should be secured to the mast, thereby relieving the strain on the cable itself.

The antenna, with reflectors, is constructed as shown in Fig. 2.

The following description of some of the commercial antennas may be of assistance to the experimenter:

**VERTROD ANTENNA**

This antenna consists of an adjustable dipole antenna for FM and an additional 80-foot antenna consisting of two space-resonating coils. This leg of the antenna is used to increase pickup of regular and short-wave broadcast band. The dipole is designed for the FM band of 42 to 50 mcs. Both antennas are coupled together in a magnetite-cored transformer, permitting efficient coupling of all frequencies to the transmission line which terminates in a matched receiver transformer at the receiver. A ground connection is required for both the antenna and receiver transformer for noise reduction on all frequencies.

Several very novel features of construction are used, particularly the cylindrical porcelain antenna transformer housing. The dipole rods are clamped on this round housing, permitting them to be adjusted to any angle without tilting the supporting pole from the vertical position. The housing is made of moisture-resisting porcelain, which protects the tropically sealed transformer from the elements. The 80-foot length of the antenna, with the two resonating coils, can be expected effectively to increase signal-strength pickup on the short-wave and broadcast bands. The antenna is broken up into three equal parts, separated by these two resonating coils. The section adjacent to the resonating antenna will function effectively on short waves, while the other loaded parts will resonate in the broadcast band, thereby permitting both the short waves and long waves to be picked up effectively.

**AIRRAIDER ANTENNA**

This antenna consists of two non-adjustable rods which are threaded at one end and provided with wing nuts. Two porcelain cleats are used for supporting these rods. Both the cleats and the rods are securely fastened together to the top of the pole by tightening the wing nuts; the porcelain cleats acting as clamps. A transformer-coupled, noise-reducing system is used for both the antenna and the receiver. A ground connection is required for both the antenna and the receiver transformer for maximum noise reduction.

**TACO ANTENNA**

This antenna consists of a dipole with a noise reducing transformer system. A special porcelain housing protects the antenna transformer and is mounted at the center of the dipole. The ground connection from this transformer must be connected to a good ground on the roof in order to receive the full benefits of the noise reducing qualities of this system. The copper flashing of the roof is quite satisfactory. The

antenna can be adjusted to any degree of polarization. A matched receiver transformer is supplied.

The frequency bands covered by this antenna include the FM, AM and short-wave broadcast.

**JFD ANTENNA**

The dipole antenna illustrated is a simple yet very effective type of antenna for FM as well as for television reception. This

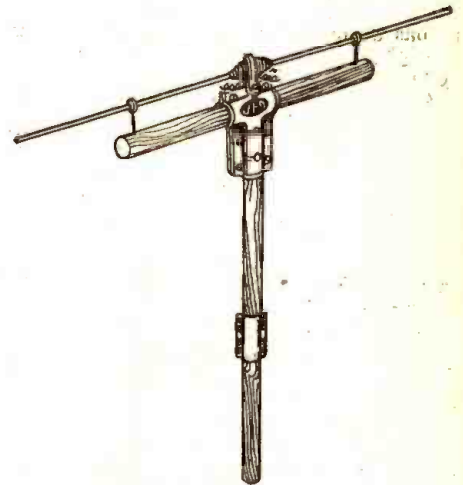

JFD TA-24 Antenna

antenna uses two 4-ft. impregnated hardwood poles for upright support. The cross-beam is also a 4-ft. pole, held rigidly at right angles by means of a cast aluminum bracket. The two dipole elements are two brass rods each about 63" long and are held in place by means of porcelain insulators. The inside ends of these two dipole rods screw on to a specially designed insulator which affords two separate contact terminals to which the transmission line is ultimately attached. This arrangement is mechanically simple yet sturdy and extremely effective for ultra-shortwave reception. No transformer is supplied with this aerial since it is normally used with sets having a built-in antenna-matching transformer. The cross-arm bracket is of such mechanical construction as to permit rotation of the dipole elements in a horizontal plane to obtain the maximum results from the directional effect of this antenna.

(The antennas described by Mr. Werthimer, in addition to the one he designed, were included in this article merely to illustrate the features of some of the commercial types of FM antennas. Because of priorities on essential war materials the manufactured antennas are not now available for amateur use.—Editor).

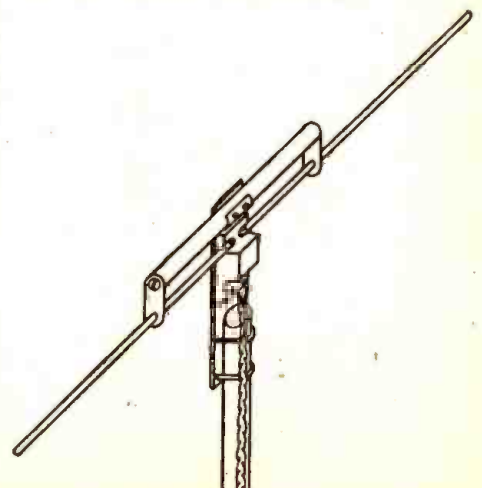

Taco 486-P Antenna

# THE ATTIC INVENTOR'S CONTRIBUTIONS TO SCIENCE

BENJAMIN FRANKLIN MIESSNER

**T**HERE exists today a growing conviction among laymen, which is also beginning to spread among scientific workers, that the centralized, organized, research laboratories of our great industrial companies are taking from independent inventors the leadership in scientific and industrial progress. Our great dailies, in news and editorial columns, tell us of startling advances made by these laboratories; they accent the modern trend, seen too in political circles, to appoint a board of experts to settle our problems; they toll a requiem over the so-called attic inventor.

Let me quote, as an example of this point of view, an editorial that appeared in a leading newspaper:

"There can be little doubt that the day of the lone inventor, the starving genius of the attic is over. He gave us great inventions, but he took too long about it. Discoveries and improvements made decades and even generations apart had to be assembled before we had the telegraph, the telephone, the harvester, the flying machine. In the modern industrial laboratory no time is wasted in repeating old experiments. Experimenters are organized into crews. There is team work, organization, a plan of research, and competent direction . . . The prima donna of the microscope, the lone 'genius', who depends on trial and error and wastes precious, planless years by following 'hunches', gives way to a trained crew concerned with the mechanism of living."

It may be interesting at this point to review the milestones of telephone progress:

1. The telephone was invented by Reis, Gray, Edison, or Bell, from whom you may choose to your liking.
2. The loading coil which makes possible long distance telephony, was invented by Dr. Pupin, a college professor.
3. The dial or automatic exchange system came from a relatively small company in Chicago.
4. The amplifying radio tube came from an independent investigator, Dr. Lee deForest. Von Lieben and Reis invented it at about the same time.
5. The circuit to make this audion work was the contribution of another rank outsider, Fritz Lowenstein, previously first assistant to Nikola Tesla, and later inventor of the C bias, and whose assistant I was when, in 1911, we took a sealed box and demonstrated to telephone engineers good transmission through 30 miles of standard cable boxes, an unheard of feat at the time.
6. The oscillating audion which makes possible radio transmission at any distance, and globe-girdling telephone circuits, where did that come from? The patent courts were for a long time besieged by litigation on whether Armstrong, a Columbia University student of Pupin, whose rights were acquired by Westinghouse, or Meissner (not the author of this article), a German engineer whose rights were seized by the United States during the first World War, or deForest, whose rights were held

by the deForest Company, all outsiders, was the inventor. Somehow it has never been allowed to come out in these proceedings that neither of those contestants was the first inventor. Lowenstein had audions oscillating at audio and radio frequencies early in 1911, a full year ahead of these contestants. I know it because I was there. He used vacuum-tube oscillators as labora-



Mr. Meissner and one of his first electronic pianos.

tory tools for research and he operated a complete radiotelephone system between two of his laboratories at 115 Nassau Street, New York, using a tube oscillator as a transmitter.

7. Regarding the multiplex carrier system for wire and radio, which made possible multiple simultaneous transmissions over a single circuit, the original scheme was invented by the Frenchman Blondell, or Mercadier, Elisha Gray or General Squier. Even your humble correspondent, in 1910-11, while associated with John Hays Hammond Jr., in his torpedo-control work at Gloucester, invented the modern system of multiple modulation, for multiplex and secret communication. You will find its description in my book "Radio Dynamics", 1916, (D. Van Nostrand). It is the basis of the superheterodyne receiver circuit now universally used.

Let us look at other fields. The color process now used by Eastman came from the attic research and inventions of two young musicians, Godowsky and Mannes, and thanks to the straightforward honesty of Kodak Research Director Dr. Mees, this fact was widely publicized.

In my own field—radio—let us look also at some names of the workers. Maxwell, Hertz, Popoff, Branly, Marconi, Fleming, Von Lieben, Count Von Arco, Fessenden, Stone, Hazeltine, Armstrong, Lowenstein,

*Mr. Meissner, a successful independent inventor in the field of radio, gives his views on the lone worker's plight and suggests how it might be remedied.*

deForest, Ballantine and again your unheard-of correspondent, with about 70 patents—all of us outside of organized research groups and practically attic inventors. From these and hundreds of other attic or independent inventors have come the great bulk of radio milestones.

The real milestones of scientific and inventive progress come not from the institutions of organized research, but from the constantly derided and never adequately publicized independent researchers and inventors working with feverish intensity in their little cubby-holes the country over, in the hope of winning fame or fortune.

Inventors must have incentives in order to invent. Independent inventors, though they may face long years of privation and hard work, may gain great rewards. Necessity is still the mother of invention. Group effort never promotes the zeal, the sacrifices, the brain sweat of the independent worker (remember that Mr. Edison said that genius and invention are 99% perspiration and but 1% inspiration). The real inventor is a highly individualized organism, wholly unsuited to team work and to function as a unit of a mass group. Great inventions, like great paintings, statues, symphonies, plays, or novels, are rarely made through mass effort; almost always from individual brains driven by the force of some inner fire for self-expression. A hundred horses may be able to pull a hundred times as much as one horse, but can you imagine a hundred composers writing a Tristan, or a Beethoven's Fifth Symphony? Or a hundred literary men writing a Hamlet? Or a hundred painters evolving together just one work as great as Rembrandt's?

The big organizations do have ability to perfect and commercialize inventions after they are made. The practical application of inventions takes many kinds of knowledge and many kinds of facilities (knowledge of markets, costs of productions and business generally) which the lone research worker does not possess.

Let not the issue be confused between revolutionary invention and detail development and improvement. By revolutionary inventions I mean basically new instrumentalities and methods which profoundly affect the course of an art or of civilization itself. We may take as examples steam, gasoline, or electric (motor) engines; the telegraph, telephone, radio; the electric lamp; the talking motion-picture, the automobile, aircraft. There are many other basic inventions, and any art, such for example as telephony, we can subdivide into important steps, basic to that art. Detail improvements represent the small steps between the basic milestones.

I make no contention that organized research is unimportant in detail development. It is of utmost importance. The development of such a complicated mechanism as a telephone system or an automobile requires a vast array of talent of many specialized kinds.

I do not undervalue the accomplishments of organized research and development; their *forte* lies in development *after* initiation or invention rather than in invention



itself. There is ample historical testimony to support their value for development, but there is even more to support the independent worker as the producer of basic and revolutionary steps in the progress of science and invention.

There may be other reasons why revolutionary changes come from individuals. Business men who have spent their lives learning the technical and other intricacies of one type of product and who have large amounts of capital invested in plants and facilities may not want all of these resources to be made obsolete by radical or revolutionizing new products which will supplant their own. They are interested first in cheapening their products to increase sales volume or reduce costs; if they are interested in improved products it is mostly because competing products demand this.

When the large manufacturing or service organizations do very actively initiate new developments, it is mostly as a protection against others who might do it first and therefore get in a strong competitive position. A large laboratory may take out 1,000 patents a year but may not use one per cent of these.

That the revolutionary changes do not come from within these large industries is abundantly borne out by the history of our progress in science:

1. The automobile or the flying machine did not originate in our large transportation agencies, such as the railroads or the wagon and buggy makers.
2. The radio was not the contribution of the phonograph companies whose products it has so largely displaced.
3. The talkie-movies did not come from the motion-picture companies.
4. The electric light was not given to us by the gas utilities.
5. The electric clock did not come from the clock industry.
6. Rayon was not introduced by the silk industry.

Very often even the improvements which would greatly benefit these large companies rather than the public they serve, do not originate within these companies. Surely the multiplex carrier system should have originated in Bell Laboratories, yet it did not; and there are dozens of very important such cases.

Take, for example, the Rockefeller Institute for Medical Research, probably the greatest aggregation of medical experts in the world, with unequalled facilities for carrying on their work. Yet the great bulk of new knowledge of human ailments comes from individuals and small groups scattered all over the country.

As a terrible example of group work, three radio manufacturers combined in the development of one make of radio set a few years ago before anti-trust dissolution. With all that mass of talent, they should have swept the radio business clean of competition; but they did no such thing, even with all the added pressure of combined advertising! Fifty other companies all got their share of business; now the previously minor company is out-producing the older firms.

Now the latest radio development is the elimination of static, upon which every large communication laboratory has been working for thirty years. The inventor is Edwin Armstrong, a Columbia University professor.

A relatively new development in electronics is Electronic Music. Does it not seem strange that these new instrumentalities are not being produced by musical instrument makers or by the great radio companies? In less than one year a clock manufacturer turned the pipe-organ in-

dustry topsy-turvy with a new electronic organ.

S. C. Gilfillan in his book "The Sociology of Invention" confirms my contentions. He says, "As to those (inventions) of revolutionary importance, the principle has been propounded and well supported . . . that cardinal inventions are due to men outside the occupations affected, and the minor perfective inventions to insiders."

There is another reason why the great laboratories create the impression of leadership. No matter where their inventions originate, the products bear the company label, and the companies tell us of these new advances by their engineers or laboratories even though they have often been acquired from outsiders.

What of the social aspects of this Doctrine of centralization in Research? There are tens of thousands of individual inventors throughout the country for whom no sacrifice is too great in working out ideas. Many of these, to be sure, are in the class of the untutored, "cut-and-try" inventors who work with the methods of "by guess and by God", like Goodyear, who made thousands of experiments in frying crude rubber in the attempt to hit upon some method to vulcanize it. Even these methods are justifiable when they produce results, particularly in the face of a contrary theory, or of no theory at all. But there is also a vast army of independent specialists who know as much about their own field as any of the company experts. Their zeal is absolutely unapproached by that of the group workers. Are they to stop work and let the big laboratories take over the job of advancing civilization scientifically? Surely they must so conclude if they believe that their individual efforts are to lead nowhere.

Instead of discouragement by such trends as the regimentation of inventors and control of their social contributions by large industrial companies, the real need is to give encouragement to independent workers with inventive abilities. They, not the group workers, are the real pioneers in the technical march of civilization, and too often indeed, they live and die unknown and unpaid. I say this with no personal feeling of resentment, for I have in recent years been very well paid for my inventions. But I have a very real compassion for those sincere and capable men who do important work yet go wholly unrecognized. I myself went through those ordeals for many years. These men carry on, for the most part, with inadequate facilities. They never can scrape together one-tenth the money necessary for patent-office and attorney's fees, to protect their inventions. Most of their inventions never reach the patent office because they are too impoverished to pay for this protection. Our patent system is set up on the basis that, if an inventor will disclose his inventions to the world, his government will grant him the exclusive right to prevent others from making or using it without profit to the inventor for seventeen years; after that for all eternity, it is public property free for manufacture and use by all.

In this, the scientific age, when technical progress accelerates as never before, does it not seem exacting and cheap on the part of our great people and their government to make these inventors pay for that seventeen years of protection? Besides, that so-called protection is not protection at all; it merely gives the inventor the right to sue infringers, a proceeding in which the court stands merely as a judge, and not as the inventor's protector.

These conditions present no severe handicaps to the group inventors. Their com-

(Continued on page 700)

**The Book that takes Drudgery out of Mathematics**

Only **50¢** postpaid

**SOLVES EVERYDAY PROBLEMS — HELPS YOU GET AHEAD IN LIFE**

How many times have you lost money because of a mistake in figuring? Do you know how to figure quickly and correctly? Can you figure discounts, interest rates, taxes and all the other calculations you meet up with in your daily life?

Are you having trouble qualifying for Army or Navy promotion because you're not up on mathematical? Here is the book that gives you a good background in mathematics; that takes all the irritation and drudgery out of it. You don't need to be scared of mathematics, because here's the subject explained without frills, without useless computations.

Here's the book for men in the armed forces; for business men; technicians and craftsmen, explaining and answering everyday mathematical problems in easy-to-understand words and illustrations.

Yes, it's the key to a simple understanding of mathematics. It's a real home-study course in mathematics for the man who's alert to the importance of mathematics in the world today.

**ELEMENTARY MATHEMATICS**

• EASY — SIMPLIFIED — PRACTICAL •

- CONTENTS OF BOOK**
- CHAPTER I. Arithmetic—Addition—Subtraction—Multiplication—Division
  - CHAPTER II. Factoring and Cancellation—Fractions—Decimals—Percentage—Ratio—and Proportion.
  - CHAPTER III. The Metric System
  - CHAPTER IV. How to Measure Surfaces and Capacity (Geometry)
  - CHAPTER V. Powers and Involvement—Roots and Evolution
  - CHAPTER VI. Mathematics for the Manual and Technical Craftsman—Thermometer conversions—Graphs—Curve Plotting—Logarithms—Use of the Slide Rule.
  - CHAPTER VII. Special Mathematics for the Radio Technician.
  - CHAPTER VIII. Commercial Calculations—Interest—Discounts—Short Cut Arithmetic
  - CHAPTER IX. Weights and Measures—Useful Tables.

ONLY **50¢** POSTPAID

Send Stamps, Cash or Money Order.

Send today for your copy of this indispensable book. It can be carried readily in your pocket. (Size 8 1/2 x 9 in.)

**TECHNIFAX**

1917 S. State St., RC-742, Chicago, Ill.

**SPRAYBERRY RADIO TRAINING**

includes **FULL EQUIPMENT**

Experience Easily Acquired at Home



You Do Practice-Giving Experiments. Many Special Features. ALL Designed to Help You Make Fast Progress

SPRAYBERRY Training starts right at the beginning of Radio. . . unfolds each subject in a simplified, logical understandable style. You easily learn Television, Frequency Modulation, Signal Tracing, Mobile Radio (Auto-Tank, Aviation Radio), Electronics, Facsimile Radio, Radio Set Repair and Installation work.

Training Prepares You for a Business of Your Own . . . Or Good Radio Jobs at Excellent Pay

The great fascinating and progressive field of Radio offers many opportunities to the man who wants to get ahead. My Training is designed to give you quick access to these opportunities. SPRAYBERRY Methods are thorough and practical. Your Training will not interfere with your present work. No previous experience is needed.

You Get Professional Test Equipment Plus Complete Radio Set

With the Radio Parts given (everything needed to build a Complete Receiver) you conduct interesting informative experiments with your own hands. Also you are supplied a modern TESTER-ANALYZER.

Earn While You Learn

My BUSINESS BUILDERS show you how to put your equipment to actual use in handling money-making Radio Service Jobs shortly after you begin Training.

THE SPRAYBERRY COURSE IS SOLD UNDER MONEY-BACK AGREEMENT

**RUSH COUPON for BIG FREE BOOK**

SPRAYBERRY ACADEMY OF RADIO  
F. L. Sprayberry, President  
620 University Place, N. W.  
Washington, D. C.

Please rush my FREE copy of "HOW TO MAKE MONEY IN RADIO."

Name . . . . .  
Address . . . . .  
City . . . . . State . . . . .  
(Mail in envelope or paste on penny postcard)

# A RADIO-ELECTRIC BALANCE

The article by Mr. Janis is intended to show the radio inventor and experimenter how their ideas may be put to use in developing radio applications that may improve or speed up production in war industries. Any contributions which our editors believe to be of a military or secretive nature will first be submitted to the proper authorities.

V. EDWIN JANIS

ALL of us have had brain children—ideas which, unnurtured and unsung, never quite got beyond the initial idea stage. Somehow none of us has had much time to do anything about them. But now that we can't beat a fist out on the air, a lot of those long neglected ideas will be coming into their own. It is the purpose of this article to initiate a little extra push to help you to get going. For instance, there are quite a lot of typical circuits and prin-

ciples of radio that should and can be applied to various other fields.

The photographic industry, the chemical industry, textiles, plumbing, paint, and literally hundreds of other interesting manufacturing processes are just waiting for real practical ideas that will further technical development.

To start things out on the right foot, and to give some inkling as to what is wanted, let us give consideration to the instrument used for accurately weighing out samples for analysis in chemical laboratories.

In thousands of laboratories throughout the country, every sample that is weighed, finds its way to the Chemical Balance. This is a delicately balanced and rigidly constructed teeter-totter arrangement, which has two hanging pans at each end. The whole system is balanced by an agate (or similar hard material) knife-edge resting on a block of agate. See Fig. 1.

The sample to be weighed is placed on the left-hand pan and various brass weights are tried on the right hand side until the correct combination is finally found so that the long needle pointer will swing the same number of degrees to the left and then to the right.

This is not only a tedious process, but one which requires a great deal of time. One must remember that this procedure has to be followed, every time a sample has to be weighed. Think of the time and energy that could be saved if this process were simplified. Our problem now, is to devise a method of weighing a sample both accurately and, at the same time, quickly.

## THEORETICAL CONSIDERATIONS

A brass weight, is after all, only a pull exerted on the balance pan by the force of gravity. Various sizes of weights cause gravity to pull the pan downwards with corresponding energy. What we need, then, is something which will exert a force and which we can control and measure. We have at our disposal several mediums which will fill the bill as far as these qualifications are concerned. *Magnetism* is the first thing that comes to our mind. Why not have a magnet arranged so that by varying the current we can exert the exact force necessary to balance the sample?

Refer to Fig. 2. Here we have an arrangement where, with the sample on the left side of the balance and an electromagnet on the right side, the amount of current necessary to balance the sample, is our indication of the weight of that sample. We have to control the amount of current that we send through the electromagnet, so our next step is one that becomes familiar to all.

Arrange a triode in a circuit so that the grid EMF can be measured. This will give us a very sensitive control over the plate current, which we will use to drive the electromagnet.

In the Metric system of weights and measures, the gram is our standard unit of weight. To arrange for our balance to measure, say, one thousandth of a gram (.001),

we must measure the grid EMF to the same fraction. In a potentiometer circuit of one meter length this corresponds to one millimeter, so that a potentiometer in the grid circuit is just what the doctor ordered. Now another problem. So far, in theory, we can exert a one gram force. How about the rest of the weight? Well, that one's easy—the use of the brass weights for the rest of it takes no time at all, so we'll use our measuring device only for that portion of the weight from one gram down to one thousandth of a gram. For example, if a sample weighs 15.873 grams, fifteen grams are balanced by brass weights, and the .873 grams can be measured by our grid potentiometer. Since every millimeter equals .001 grams, then our slide, for this sample, would be set at 87 and .3 centimeters or 873 millimeters.

The complete circuit would look like Fig. 3.

The actual operation would follow this pattern. A one-gram weight is placed on the left balance pan and the grid slider S is placed at the end of the potentiometer resistance PR. This corresponds to 1,000 millimeters on the meter stick M. Now the C bias resistance R is altered until just enough plate current flows to balance the weight of one gram. In this manner we have the correct bias potential drop across our measuring potentiometer, and if the tube is working perfectly on the straight-line portion of its curve, we can now measure any portion of a gram to within one thousandth part.

This, of course, has been entirely a "mental model" and many difficulties will arise in actual construction. Here are a few of these "bugs" and what to do to eliminate them.

First of all we should consider the relation of magnetic force exerted, to current. Are they proportional or do they vary with a power? Another thing—what tube to use. Maybe a variable mu tube would be better since we can control the slope of the plate current output. We certainly have to arrange to have the tube working on a perfectly straight line or our results just won't add up.

## OTHER THEORETICAL POSSIBILITIES

How about some other methods? Well, we can try the effect of weight on a condenser arranged so that its capacity will be variably altered. If now we use this condenser in an oscillating circuit, any alteration of capacity will produce a decided change in the frequency of oscillation. Our frequency formula

$$f = \frac{K \times 1}{\sqrt{LC}}$$

where K is a constant, L the inductance, and C the capacity; indicates that the reciprocal of the square root of the change in capacity (a very small numerical unit when high frequencies are used) alters the frequency in such a large proportion that it should be no great difficulty in measuring

(Continued on page 704)

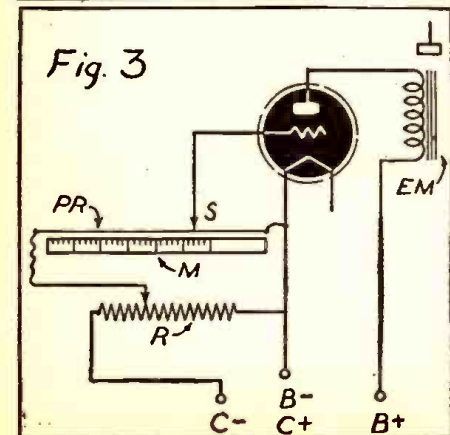
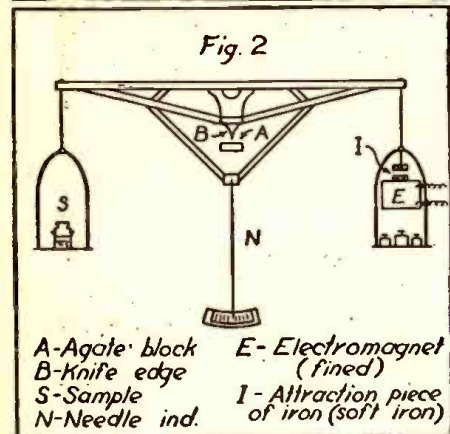
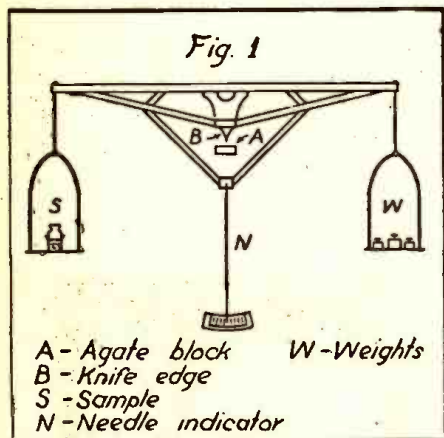

## HIGH-SPEED LIMIT BRIDGE

Industrial Instruments, Inc.  
156 Culver Ave., Jersey City, N. J.

**P**RODUCTION testing of capacitors and resistors and inspection for conformance with tolerance specifications are speeded up with the high-speed limit bridge manufactured by Industrial Instruments, Inc. Features claimed are: Negligible setup time, great flexibility, wide range, accuracy within 1% plus or minus of standard, high speed and extreme ruggedness.

For checking capacitors, Model LB-1 covers a wide range of capacity values when used in conjunction with the DK-2A Decade Capacitor supplied by the same manufacturers, having a range of .001 to 1.1 mfd. in .001 mfd. steps. However, the bridge can be used with decades of other ranges, or with independent capacitance standards. The accuracy of plus or minus 1% is based on the use of a standard that comes within that tolerance.

For checking resistors, Model LB-2 is supplied with a resistance standard having a range of 1,000 ohms to 1.11 megohms. Other resistance standards may be used if desired. Different models are required for capacitance and resistance measurements.

For production testing all that is necessary is to set the instrument's high-low dials for the desired plus-minus limits. The closing of the corresponding cathode-ray null indicator gives immediate warning when limits are exceeded.

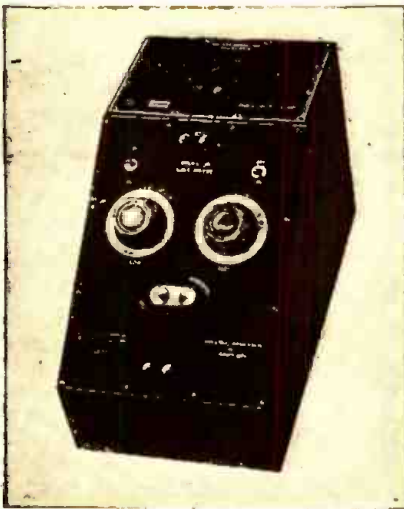

The wide range of the limit bridge makes it especially attractive to those engaged in production testing of many different values. Instead of having a large variety of meters calibrated in different ranges, it is now possible to use a single limit bridge together with the necessary choice of standards to cover any required ranges. This reduces the investment in production instruments and simplifies procedure.

The fact that the indication is instantaneous with the limit bridge, as contrasted with a meter indicator which must swing and come to a stop, means faster operation. With properly trained operators, speeds up to 1,000 condensers or resistors an hour are entirely feasible. Also, the absence of a sensitive galvanometer means extreme ruggedness for the limit bridge, as well as complete freedom from costly and troublesome burnouts. No harmful effect from a dead short or inadvertent measurement outside the range of the instrument can damage it.

The instrument is entirely self-contained and furnished complete with tubes, ready to operate on 105-130 V. 50-60 cycle A.C.

Since it utilizes the Wheatstone Bridge circuit, readings are independent of line voltage fluctuations and tube characteristics.—*Radio-Craft*

## NEW R.C.P. VACUUM-TUBE VOLTMETER

Radio City Products Co.  
127 W. 26th St., New York, N. Y.



**A**CCURATE measurements throughout the entire audio-frequency range, including super-audible frequencies, are simplified by R.C.P.'s new Model No. 666 vacuum-tube voltmeter.

Essentially a peak-type voltmeter, this model has a constant input resistance of 16 megohms. Although designed for 105-130 volts, 60-cycle operation, provision has been made for external battery operation through appropriate terminal connections and a throw-over supply switch.

Readings are made quickly and easily on this latest RCP model, a time-saving feature that suggests immediate popular acceptance. The instrument is equipped with a 4½-inch rectangular meter having a movement of 0-200 microamperes.

Ranges are 0-3-6-30-50 volts. Tubes used are type 6K6GT, 6X5GT, 6H6 and VR105 30. The last is a voltage regulator, eliminating errors due to line-voltage fluctuations.

The vacuum-tube voltmeter is made in a handsome grey finish steel case with sturdy leather strap handle.—*Radio-Craft*

## TYPE XJ HIGH VOLTAGE FILTER CAPACITORS

Solar Manufacturing Corp.  
Bayonne, N. J.



**T**YPE XJ capacitors provide a wide range of capacities in D.C. voltage ratings from 6,000 to 25,000.

Liberal design and rigidly controlled production processes have been combined to

produce a unit which is mechanically rugged and electrically dependable.

Containers are heavy gage steel, welded oil tight and hot tinned. The wet process procelain insulators are amply proportioned to withstand potentials far in excess of the rated voltage of the capacitor. Case and terminals are bonded together by gasket material carefully treated to insure an oil tight joint under extreme temperature conditions.

The long vacuum-drying and impregnating process is performed after the completed stack is permanently assembled in the case. This eliminates the possibility of short life due to breakdown of air trapped in the windings. The vacuum-treated mineral oil impregnant assures low leakage current and negligible capacity change over a wide range of operating temperature.—*Radio-Craft*

## ALPERT LONG-NOSE CUTTER-RETRIEVER

Pack-Rite Machine Corporation  
828 North Broadway  
Milwaukee, Wisconsin

**T**HIS cutter-retriever resembles a pistol, the cutting edges being located at the end of the long, slim barrel. To cut wire the operator merely places the wire between the cutting edges at the "business-end" of the pistol and snips off the wire by bringing down the trigger which actuates a rod operating inside the barrel of the pistol. The leverage ratio is 15 to 1, hence practically no thumb pressure is required on the trigger.

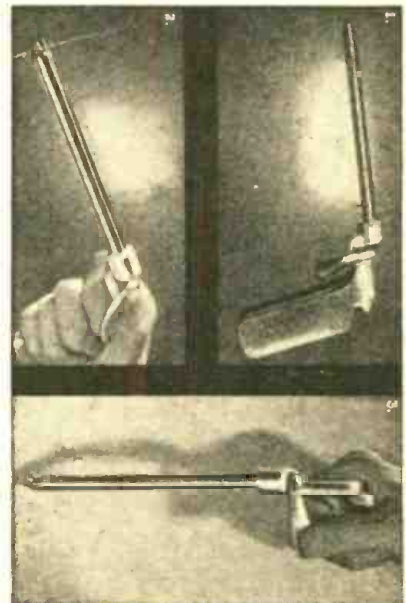

To retrieve a bolt, nut, washer, cotter-pin, etc., which may have dropped into an inaccessible place, the "long-nose" barrel is merely poked into the hard-to-get-at place, the trigger brought downward and the hardened steel cutters pick up the missing part.

The cutter-retriever is light weight, flat, easy to slip into a belt or holster.—*Radio-Craft*

## DYNAMOTORS

General Electric Company  
Schenectady, N. Y.

**T**HESSE dynamotors are specially designed for communication service. Because of the small physical size and the relatively high voltages encountered, insulation is unusually important in the construction of a dynamotor. General Electric has developed

(Continued on page 693)

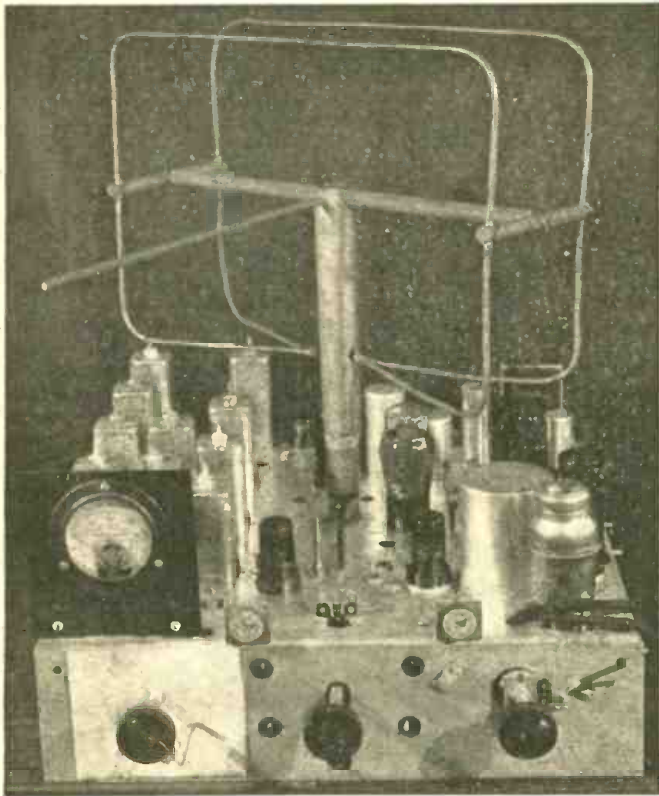

Fig. 1—A vertical loop-type antenna.

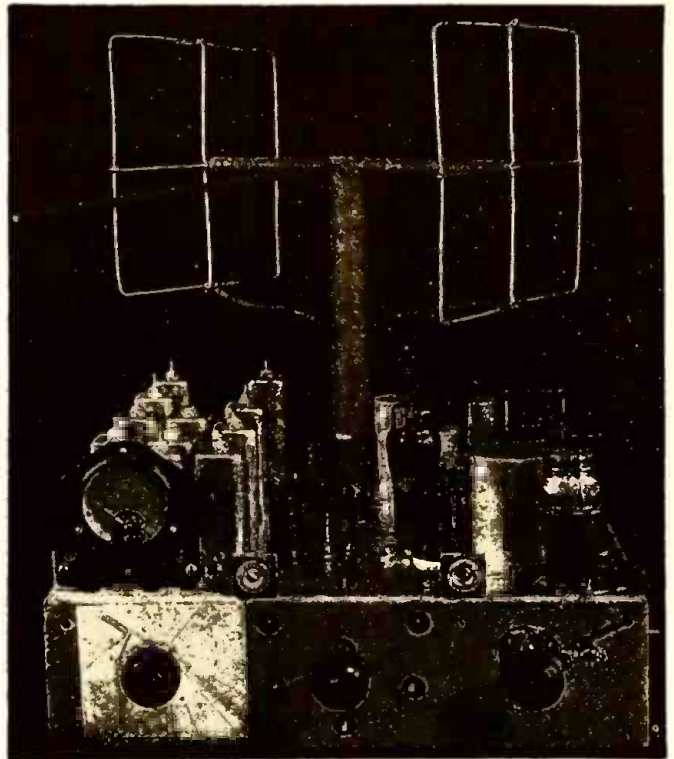

Fig. 2—A horizontal dipole with end-capacitance load.

## TELEVISION RECEPTION WITH BUILT-IN ANTENNAS

W. L. CARLSON\*

**T**HE loop antenna enjoyed a few years of popularity in the early days of broadcasting, but was later discarded in favor of the better performing outdoor antenna. Recently, changed listening habits of the public, higher-power broadcast stations, technical improvements in receivers, and other factors have contributed to the revival of the built-in loop antenna for standard-broadcast reception.

It is natural to ask whether the future trend of the television receiving antenna will follow the history of the standard-broadcast antenna. It seems likely that the popularity of the built-in antenna for standard broadcast will stimulate a demand for a built-in antenna for television. Factors related to this question such as the propagation of ultra-high-frequency waves through buildings and their reception on small antennas have been recently investigated. The results obtained are reported in this paper.

Before taking up these results, it may be well to review the work of others which seems most pertinent to the subject. It has been shown by Trevor and Carter<sup>1</sup>, Norton<sup>2</sup>, and Brown<sup>3</sup> that for outdoor reception free from obstructions and at ultra-high frequencies such as 50 megacycles, the field strength near the ground is substantially stronger for vertically polarized waves than for horizontally polarized waves. Data are presented in the present paper which show substantially the same relative response, as found by the above mentioned investigators, for waves received at an outdoor location free from nearby obstructions after having been propagated through low build-

*SUMMARY—Television antennas suitable for mounting within a console receiving cabinet are described. A small loaded dipole was found to be more sensitive than a loop of equal size.*

*Data are given for reception in buildings on receivers with built-in antennas. Reflections caused standing waves, which affected reception of both horizontally and vertically polarized waves. The presence of people near the receiver had the most effect on the signal strength received when vertically polarized waves were utilized. Good reception in steel-frame buildings was limited to the side of the building having an unobstructed path to the transmitter. Normal obstructions in the vicinity of the antenna, such as might be encountered in residential locations, were found to attenuate vertically polarized waves more than horizontally polarized waves.*

*A field survey of wave propagation through normal city obstructions is recorded. A close agreement with theoretical open-country propagation characteristics was obtained.*

ings such as are found in a city residential district. Brown<sup>3</sup> further shows that as the receiving antenna is raised approximately 30 feet above ground, the two types of polarization yield practically identical field intensities when the transmitting antenna is at least one wavelength above ground. Also the usual radio-noise fields in the ultra-high-frequency range are stronger in the vertical than in the horizontal plane. Therefore, in spite of the preponderance of vertically polarized field near the surface of

the earth, horizontally polarized waves yield a more favorable signal-to-noise ratio for television and aural broadcast services (between 30 and 100 megacycles) where the transmitting antenna is at least a few wavelengths above ground level.

Wickizer<sup>4</sup> found 4.3 db higher average field strength for horizontally than for vertically polarized waves during a survey along highways with the receiving antenna 10 feet above ground. This can be explained by assuming that the normal obstructions encountered along the highway attenuated vertically polarized waves more than horizontally polarized waves. Englund, Crawford, and Mumford<sup>5</sup> showed that trees along the roadside absorbed and reflected vertically polarized waves. Data are presented in this present paper which indicate that trees do not materially affect horizontally polarized waves at 69 megacycles.

Jones<sup>6</sup> showed field-strength contours within a dwelling with reception of vertically polarized waves. Data are presented in this present paper which indicate that wood frame houses interfere more with vertically polarized waves than with horizontally polarized waves.

### ANTENNA DESIGNS

A television receiving antenna, confined within a console cabinet, may be directional with means for orienting its reception characteristics or it may be nondirectional. A vertical loop may be employed as a bi-directional antenna for reception of vertically polarized waves or a horizontal dipole may be employed for bi-directional reception of horizontally polarized waves. For nondirectional reception a

\*RCA Manufacturing Company, Inc., Camden, N. J.

vertical dipole or a capacitive element terminated through a coupling inductance to chassis ground may be employed for vertically polarized waves or a horizontal loop or folded dipole may be employed for nondirectional reception of horizontally polarized waves.

A directional built-in antenna with means for rotating it can be employed to discriminate against interference, including undesired reflections. The nondirectional type of built-in antenna is less expensive and usually will occupy less cabinet space.

Figures 1 and 2 are photographs of two experimental types of built-in antennas which were adapted to the RCA TRK-120 television-receiver chassis. Figure 1 shows a vertical loop-type antenna. The two turns are in parallel and are connected to an inductor through a wave-change switch. The antenna circuit functions as a full-wave resonant circuit and is coupled to a conventional, resonant grid circuit. The circuits are designed to give a band-pass characteristic of about 5 megacycles width. Figure 2 shows a horizontal dipole with end-capacitance load. It connects to an inductor which couples to a resonant grid circuit as in the case of the loop design. These antennas both have a figure-eight reception pattern in the horizontal plane. Both are rotatable about a vertical axis. The loop is 10 by 14½ inches. The dipole ends are 8½ inches square and are separated by 12 inches. The same cabinet space will accommodate either antenna. Provision is also made through a wave-change switch for operating the sets on conventional antennas through a transmission line.

The relative sensitivity of these antennas and of a half-wave dipole connected to the receiver through a short transmission line of negligible loss is given below. The measurements were made at 69 Mc in an open field with horizontal-wave polarization. The loop was in a horizontal position for this test.

Type Antenna	Relative Sensitivity
Half-Wave Dipole .....	6
Loaded Dipole .....	3
Loop .....	2

The greater sensitivity of the loaded dipole as compared with that of the loop works out as an advantage for directional reception of horizontally polarized waves (dipole in horizontal position) and as an advantage for nondirectional reception of vertically polarized waves (dipole in vertical position).

**EFFECT OF WOOD-FRAME HOUSE ON RECEPTION**

A survey was made comparing the reception on the two receivers of Figures 1 and 2 in a typical wood-frame dwelling. A small portable transmitter with loop antenna was set up in four different locations: 1T, 2T, 3T, and 4T adjacent to the dwelling. See Figure 3. The two television chassis, with loop and loaded-dipole antennas, were tested in three different locations within the dwelling on the first floor and in one location in the field adjacent to the house. These locations are shown as 1R, 2R, 3R, and 4R. Maximum and minimum antenna microvolts (obtained by rotating the antennas around a vertical axis) were recorded for both antennas and with both polarizations. It should be noted that in these tests the dipole was always in a horizontal position and the loop, in a vertical position. The data obtained are as follows:

Trans. Position	Rec. Position	Field Test from Portable Transmitter on 69 Mc							
		Vertical Polarization Dipole				Horizontal Polarization Loop			
		Max.	Min.	Max.	Min.	Max.	Min.	Max.	Min.
1T	1R	221	55	215	50	75	5	63	13
1T	2R	125	42	125	13	125	17	38	26
1T	3R	125	62	38	20	101	23	44	13
2T	1R	161	45	113	51	161	60	130	41
2T	2R	161	16	76	23	17	6	32	5
2T	3R	68	10	88	38	51	17	63	13
3T	1R	177	75	169	40	247	45	125	32
3T	2R	87	17	26	18	195	10	33	13
3T	3R	110	75	204	40	210	45	88	33
4T	4R			225					
1T	4R	62	62	377	44	161	29	95	38
*		189	57	155	45	163	33	93	28

\*Average for transmitter positions 1T, 2T, 3T and receiver positions 1R, 2R, 3R, corrected for 100-foot separation.

The figures in the table indicate microvolts output from the receiving antennas. The transmitter loop was 2½ feet above ground. The receiver loop and loaded dipole were 6¼ feet above ground for all tests. The field strength of the vertically polarized wave at receiver position 4R from transmitter position 1T was 3.5 times the field strength of the horizontally polarized wave. This field-strength ratio in favor of vertical polarization is abnormally high. The ratio from a normal distant transmitter would be approximately as indicated in Figure 6. The loaded dipole is 1.5 times more sensitive than the loop at a given field strength.

The average effect of the house on reception is obtained by a comparison of the readings obtained outdoors (with the transmitter in positions 1T and 4T and the receivers in position 4R) with the readings obtained with the receivers indoors (with the transmitter in positions 1T, 2T, and 3T and the receivers in positions 1R, 2R, and 3R). The last line of the chart contains the average for all the indoor readings, with corrections for the difference in transmission distances compared to the outdoor readings for positions 1T and 4R.

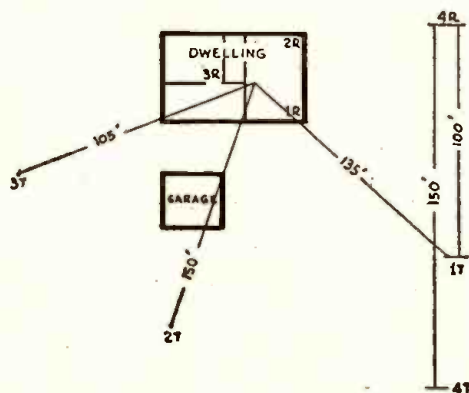

Fig. 3

The individual readings for the different transmitter and receiver positions varied widely, indicating the presence of standing waves within the house for both wave polarizations.

For horizontally polarized waves the average indoor readings were substantially the same as the outdoor readings.

For vertically polarized waves the loop maximum signal dropped from 377 microvolts outdoors to an average of 155 microvolts (40 per cent) indoors. This indicates that the polarization plane of the waves was distorted or that the waves were attenuated. The dipole maximum signal increased from 62 microvolts outdoors to an average of 189 microvolts indoors. This change indicates that the polarization plane of the

waves was distorted so as to have a substantial component in the horizontal polarization plane.

The maximum voltage recorded outdoors for vertically polarized waves on the loop was 2.3 times the maximum voltage recorded for horizontally polarized waves on the loaded dipole. Indoors, the respective average maximum voltages were substantially equal. This suggests the possibility that rain pipes, electric wiring, and plumbing as they are situated in wooden frame houses may adversely affect vertically-polarized waves more than horizontally-polarized waves.

During the tests it was noted that the maximum signal on the vertical loop, for reception of horizontal waves, occurred when the loop was turned broadside to the arriving wave. Mr. A. H. Turner offered the theory that this response was due to the differences in field strength at the top and bottom of the loop, i.e., due to the vertical voltage gradient of the horizontally polarized wave. If correct, this theory would require that the response remain constant with height of loop above ground so long as the rate of change of field strength with height remains constant. This conclusion was verified by experiments which appear to confirm the voltage-gradient theory for vertical loop reception of horizontally polarized waves.

**BODY EFFECT ON RECEPTION**

It was observed that persons moving about in the vicinity of the receiving antenna affected the reception, the greatest effect on the received signal strength occurring when a vertical dipole or vertical loop was being used. This result is to be expected since the body acts as a vertical dipole. The body effect was further investigated as follows:

The first tests were made in the open field with the portable transmitter located at point 4T and a half-wave receiving dipole located at point 4R of Figure 3. The receiving dipole was 6 feet, 3 inches high at its center. A vertical dipole was used for vertically polarized wave reception and a horizontal dipole rotated for normal maximum reception was used for horizontally polarized wave reception. A man 6 feet tall stood on a wooden support 22 inches above ground in positions at 10-inch intervals in front and in back of the receiving antenna. The recorded data are shown in Figure 4 for 69 megacycles and 45 megacycles. When the man's arms were raised parallel to his shoulders and parallel to the dipole, the effect on horizontally polarized wave reception was increased.

For each test the receiver gain was first adjusted to give the same arbitrarily chosen output of 100 microamperes without the presence of the man in the vicinity of the antenna. The new meter reading caused by

the presence of the man was then recorded. The curves are, therefore, only an indication of the relative change in output due to the presence of the man.

The tests were also made with the man in positions along a line at right angles to the direction of wave propagation. The variations in signal recorded under this condition were never greater than those indicated for positions in line with the direction of wave propagation.

A second set of tests at 69 Mc were conducted with the receiving antenna located near the middle of the living room of the dwelling as illustrated in Figure 3. In these tests the man stood on the floor. The same horizontal dipole was used for horizontally polarized wave reception. Two vertical dipoles, spaced 40 inches apart and cross connected, were used for vertically polarized-wave reception. This type of antenna gives the same bidirectional reception for vertically polarized waves as a vertical loop.

When the antennas were oriented for maximum signal strength, the results were substantially the same indoors as out-

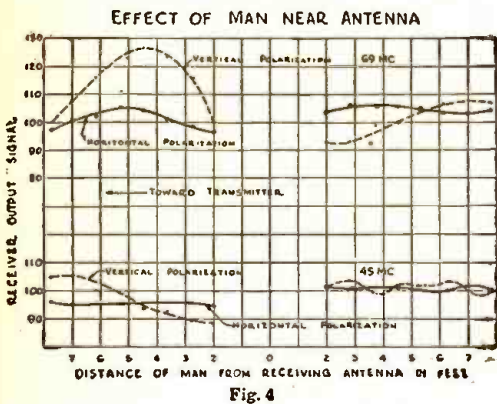

Fig. 4

doors. In one test, with the antennas rotated 45 degrees from the maximum-gain position, the response varied 2-to-1 for vertical polarization as the man walked across the room. For horizontal polarization the gain varied only 10 per cent. As the antennas were oriented towards the minimum-reception position the effect of the body became more pronounced for both polarizations.

These tests confirm the opinion that the movements of people in the vicinity of receivers operating on frequencies of the order of 70 megacycles with a built-in antenna are more likely to interfere with the reception from vertically polarized waves than with that from horizontally polarized waves. The greatest effect will be observed on the minimum response from bidirectional antennas oriented to reduce multiple images and other interferences.

RECEPTION IN STEEL-FRAME BUILDINGS

A number of field tests were conducted in New York City on television reception from Station W2XBS, Empire State Building, operating on the former No. 1 channel (44 to 50 megacycles). The results obtained at three locations on the receiver with the loaded-dipole antenna were as follows:

At 26 East Ninety-Third Street in a tenth-floor apartment, an input of 95 microvolts was obtained in a room location which gave poor results. At another location removed 15 feet, in the same room, an input of 560 microvolts gave a fair-quality picture when the antenna was oriented to reduce multiple-image re-

sponses. This location was on the side of the apartment away from the transmitter. The distance was 3 miles from the transmitter. A better picture was obtained on an outdoor antenna located on the roof.

At 75 Varick Street on the sixteenth floor facing the transmitter, an input of 1550 microvolts was recorded. This signal gave an excellent picture. Moving the receiver back towards the middle of the building gave poor results. The distance was 2 miles from the transmitter.

At the RCA Building on the fifty-third floor facing the transmitter, an input of 3000 microvolts was recorded. This gave a good picture. Another location on the opposite side of the building gave an input of 150 microvolts and a very poor picture due to multiple images. The distance to transmitter was 0.7 mile.

This survey indicates that in office buildings and apartment houses of steel construction, dependable service using built-in antennas will probably be found in locations facing the transmitter and preferably within line of sight. A bidirectional antenna is desirable to reduce multiple images.

EFFECT OF CITY OBSTRUCTIONS

The relative field strength of vertically and horizontally polarized waves passing mainly through residential areas was also investigated. For these tests a half-wave dipole receiving antenna was located remote from the receiver and buildings so as to minimize the effect of nearby obstructions.

The small test transmitter previously referred to was placed 5 feet above ground in a residential location at Haddonfield, New Jersey. The receiving dipole antenna was placed in three different locations in a field, at heights ranging from 4 to 12½ feet. At the transmitter site the ground was about 40 feet higher in elevation than the receiving locations, most of the ground rise occurring near the transmitter. The transmission distance was 0.6 mile. The receiving locations were about 150 feet from each other and about the same distance from the nearest trees and metal fences. There were eight rows of detached dwellings between transmitter and receiver. The nearest houses in line with the propagation path

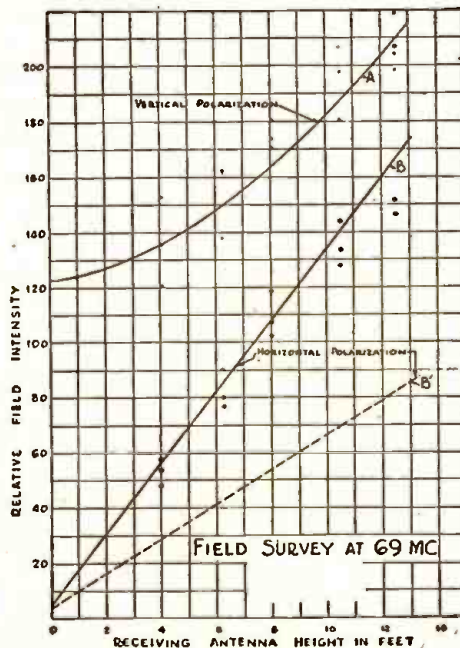

Fig. 5

were 300 feet from the receiving locations. The data obtained are recorded in Figure 5. The dots are for vertically polarized

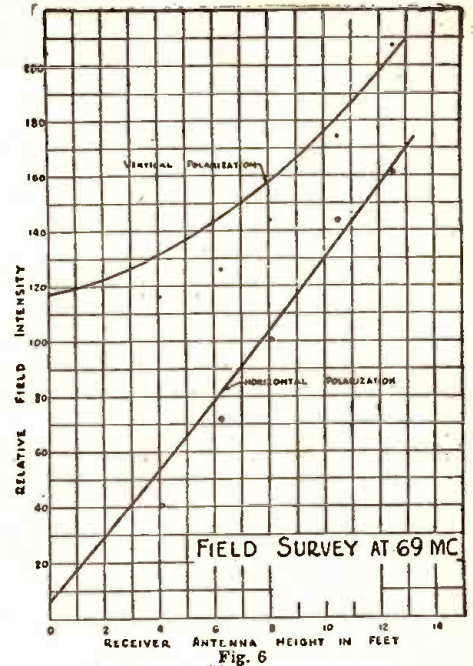

Fig. 6

waves and the circles are for horizontally polarized waves. The solid-line curves A and B were plotted from the results of theoretical calculations<sup>3</sup>, in which a ground dielectric constant of 15 and a transmitter height of 43 feet were assumed. With a transmitter antenna height of 5 feet, the response to horizontally polarized waves relative to vertically polarized waves would be approximately in the ratio of Curve B' to Curve A.

Further tests were conducted with the portable transmitter located 10 feet above the roof of Building No. 5, RCA Manufacturing Company, Camden, New Jersey. The loop antenna was about 110 feet above ground. Figure 6 gives the field strengths recorded at the Camden Airport, a distance of 2.5 miles. As in Figure 5, the solid curves represent the theoretical calculations. Most of the intervening buildings along the transmission path were of brick and metal-frame construction. The terrain was practically level throughout the transmission path.

A test run in back of the airport gave the same field strength for horizontally polarized waves as recorded in Figure 6. The field strength for vertically polarized waves was about the same as for horizontally polarized waves. Around the receiving location the only obstruction which might have caused this drop in vertically polarized signal was a long 6-foot high metal fence 1000 feet away from the receiver in the direction of the transmitter. A reflected wave from some distant object may have caused this result.

With the transmitter in the same location, another group of observations were made with the receiver located in Knight Park, Collingswood, New Jersey. On vertically polarized reception the field strength was normal in one location which was 200 feet remote from any obstacle, see Curve A in Figure 7. The field strength (Curve A') was considerably reduced for the second location surrounded by trees. These observations were made in November. There was close agreement in the recorded data for horizontally polarized waves at the two locations. See recorded data B and B' in Figure 7. The terrain was fairly regular over the ¾-mile transmission path. There were numerous dwellings and miscellaneous buildings between transmitting and receiving locations.

The close agreement between experimental data and theoretical calculations as recorded in Figures 5, 6, and Curves B and B' in Figure 7 indicate that low buildings and other city obstructions in the transmission path do not materially affect the relative field strengths of horizontally and vertically polarized waves. The observations which did not agree with the theoretical calculations can usually be ac-

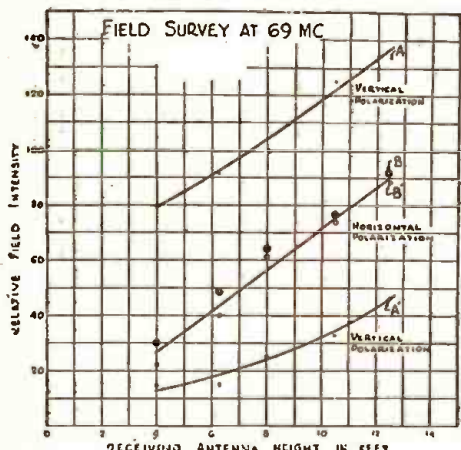

Fig. 7

counted for by objects in the vicinity of the receiving location which absorbed and reflected vertically polarized waves more than they did horizontally polarized waves.

The author expresses appreciation for the assistance of Dr. G. H. Brown and Messrs. E. O. Johnson, V. D. Landon, and A. H. Turner in connection with this investigation.

<sup>1</sup>Trevor and Carter, "Notes on Propagation of Waves Below Ten Meters in Length," *Proc. I.R.E.*, March 1933.

<sup>2</sup>K. A. Norton, "Statement on Ultra-High-Frequency Propagation," *Television Hearing Before FCC*, Jan. 15, 1940.

<sup>3</sup>G. H. Brown, "Vertical versus Horizontal Polarization," *Electronics*, Oct., 1940.

<sup>4</sup>G. S. Wickizer, "Mobile Field Strength Recordings of 49.5, 83.5, and 142 Mc from Empire State Bldg. Horizontal and Vertical Polarization," *RCA Review*, April 1940.

<sup>5</sup>Englund, Crawford, and Mumford, "Some Results of a Study of Ultra-Short Wave Transmission Phenomena," *Proc. I.R.E.*, March 1933.

<sup>6</sup>L. F. Jones, "A Study of the Propagation of Wavelengths Between Three and Eight Meters," *Proc. I.R.E.*, March 1933

—RCA Review

### "SHARE THE SPARE PARTS" PROGRAM LANDED

James Lawrence Fly, Chairman of the Defense Communications Board of the Federal Communications Commission, declared last month his gratification with the broadcast industry "share the spare parts" program recommended to the War Production Board by the DCB.

Pointing out that similar pools have been organized within industries in local areas, Mr. Fly said: "I believe that this is the first time a whole industry has proposed to share its repair and maintenance material on a nation-wide basis. There may be something here that other industries might find useful when adopted to their particular needs. Should the plan get under way it will have a real meaning to the radio listening public because the broadcasters have shown the foresight to meet the recurring emergencies of equipment failures".

He added that he had promoted this general idea for many months but until very recently the shortages of replacement parts had not become acute. "Operation of the plan, in my opinion," he said, "will result in lessening the pressure put upon the Government for immediate priorities certificates and will assure the public of continued radio listening."

## Mystery Receiver Correspondence

Editor:

I have read with interest the explanation of my Super T.R.F. circuit which latter was published in July 1941 issue of *R. & T.* page 148. I refer to the explanation offered by Mr. Gerald J. Cassens on page 511 of the April issue of *Radio-Craft*.

Mr. Cassens fails to throw any light upon the operation of this circuit, for the sole reason that he does not seem to realize that the circuit is equipped with an oscillator. He apparently mistakes the oscillator coil "C" for a regular R.F. coupling transformer. The oscillator is the heart of this system and has much to do with the process of tuning and also the zero-beat action.

However, he comes very close to the critical point when he notes that there is electron coupling between the two sections of the 6J8 tube by reason of the direct connection which causes the heptode to function as an oscillator-mixer and not as an amplifier.

The heptode produces both zero beats and I.F. beats. The zero-beat signal is the only current that operates the speaker and is heard, while the I.F. current serves only as

an aid to sharper tuning, and is finally filtered out into oblivion, where it is silent as the Sphinx.

I think Mr. Cassens' explanation of the action of the triode half of the 6J8 is substantially correct.

Mr. Cassens brings out one interesting

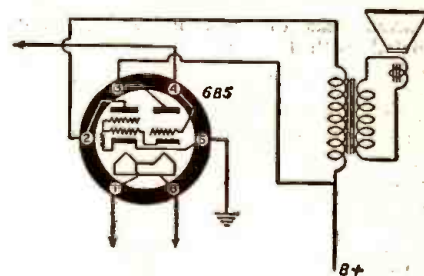

point at the end of his article: He hints at a better way in which to hook up the 6B5 power tube. I would like to know just how he would do that. Maybe this is it (see 6B5 sketch).

RALPH W. MARTIN,  
Los Angeles, Calif.

## Mr. Martin Still Is At It

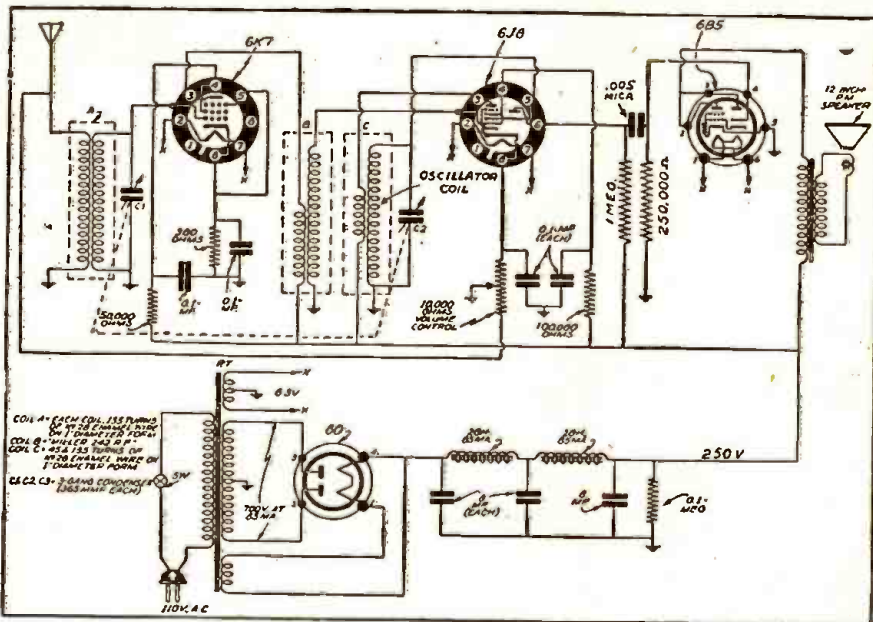

Mr. Martin has expanded his 4-tube receiver into a 7-tube arrangement, but his recent correspondence asks that it "be relegated to the ash-can." Instead he offers a revised 4-tube receiver, the diagram and his explanation of which are published here.

Editor:

As shown by the accompanying diagram —when it is compared with the diagram published in *R. & T.*, page 149, issue of July 1941—one tuning condenser has been eliminated, thus reducing the tuning tank from a three to a two-gang unit.

The other change has been the replacement of the audio transformer by resistance coupling. This greatly improves the fidelity, especially the bass response. These changes may seem slight but they often mean far-reaching results.

As yet, the crux of the problem as a whole hovers about the mysterious action

taking place within the 6J8 tube. As is well known, a straight TRF having only a two-gang tuning condenser has barely enough selectivity to get by on. Nevertheless, this circuit has been carefully compared with a super-het five, and the selectivity of both sets has been found to be practically the same. The super-five had one stage of TRF and two I.F. transformers, both double-tuned. The mystery of the 6J8 tube still remains a mystery.

The coils used in this latest hook-up are exactly the same as published in connection with the July '41 article.

There are still some rough spots in this circuit that must be ironed out, but the possibility of perfecting a circuit combining extreme simplicity, high fidelity, and high selectivity is getting closer with every effort.

RALPH W. MARTIN,  
Los Angeles, Calif.

# A 2-4 TUBE PROGRESSIVE RECEIVER for 110 Volts A.C. - D.C.

L. M. DEZETTEL, W95FW\*

## PART II—ADDING THE AMPLIFIER

This receiver was designed for the beginner in radio set construction. Part I, which appeared in the June issue of Radio-Craft, pages 632 and 633, described the Headphone Unit and showed how the chassis layout provided for inclusion of an amplifier for loudspeaker reproduction.

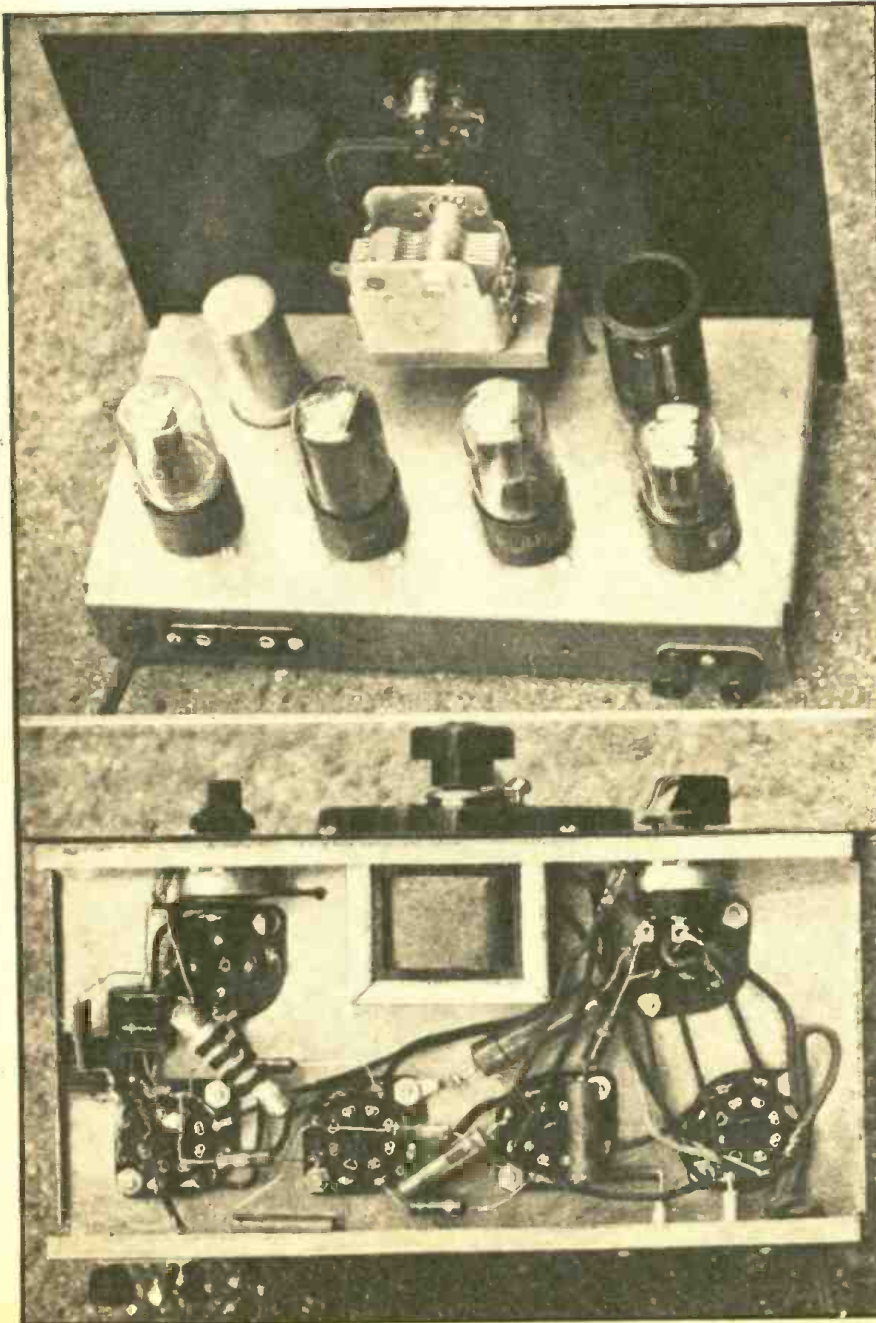
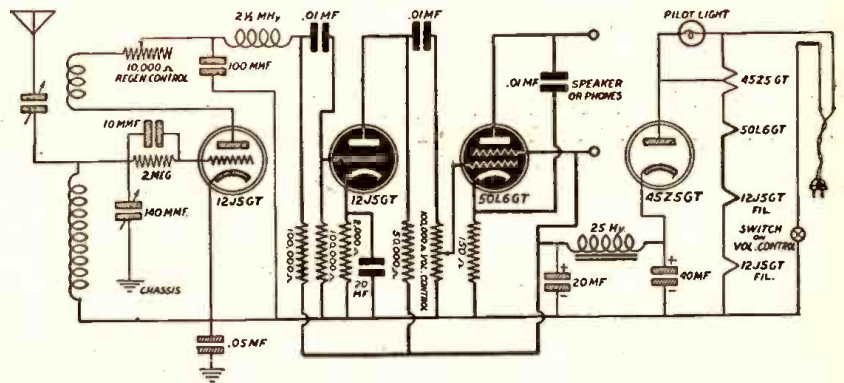

LAST month we described the first of a series of two articles on a 4-tube AC-DC All-Wave receiver of simple design. We showed you how to make a 2-tube set that would work well on ear-phones. If you followed the chassis lay-out given, you will have room to add a two-stage amplifier to your receiver, so that good loudspeaker operation may be enjoyed.

This article gives necessary information for making the additions. Incidentally, the additions shown here can be made to any one or two-tube set you may now have. For other sets than the one described last month, we suggest that the line cord have a 360-ohm dropping resistor built into it for dropping the filament voltage for just the two tubes, so that it will not be necessary to cut into the heater series circuit of your present AC-DC set. "B" voltage must be taken from the set, however.

The two tubes selected for the amplifier portion of the receiver are 12J5GT and 50L6GT. They were selected primarily because their heater voltages when added to the two tubes used in the receiver of last month total 119 volts, which is just about right, when they are connected in series, to operate them directly from the house lighting circuit. This arrangement economizes on the energy otherwise lost in heater dropping resistors.

### TWO-STAGE AMPLIFIER ADDED

Study the diagram carefully. Notice that it is the same as for last month's receiver, except for the two-tube resistance-coupled amplifier that has been added. The bold lines represent the hookup of the two-tube amplifier addition.

If the original chassis layout was used, it is a simple matter to make the addition. Octal sockets are mounted in the two middle holes provided for them. The rotary "on-off" switch is now replaced with a 100,000-ohm volume control, with a built-in line switch. The wiring tie point insulator shown in the under-chassis view of the two tube set may be dispensed with, as the unused contacts on the two sockets we add are used for wiring tie points. The 400-ohm 10-watt filament dropping resistor is taken out of the circuit. Otherwise, all of the parts used in the original circuit are used again here.

### INVERSE FEEDBACK INCLUDED

Make all of the connections as short and direct as possible. Note that the extra 20

(Continued on page 697)



# FACTORS CONTROLLING MAN-MADE RADIO INTERFERENCE

R. A. SHETZLINE\*

**W**HENEVER there is a sudden change or interruption in current in an electric circuit, such as results from the opening or closing of a relay or switch, a series of alternating voltages is generated at frequencies which extend over a very broad range. Thus when any wire transmission circuit, whether used for power or communication purposes, is in the vicinity of a radio receiver, voltages may be set up which may cause noise in the radio receiver. The influence of these voltages depends on their magnitudes at the frequencies covered by the radio channels affected, and the values of these voltages, in turn, depend on the amount of current change involved and the circuit constants. The importance of any such disturbance as a source of radio noise is thus a complex function of the voltages and frequencies involved, but in general it is measurable, and called the noise-influence level, designated "NI."

In any study of methods of controlling man-made noise in radio receivers, it is necessary to know the manner in which the noise influences under consideration reach the radio receivers. For purposes of illustration, a generalized situation is shown in schematic form in Figure 1. This generalized situation as will be seen covers the special case in which the noise influence is assumed to arise within the telephone plant, such as in a telephone central office at point x, and the radio antenna and receiver are some distance away at point z. The radio receiver, it is assumed, is in a house that has a telephone served by the central office at point x, and an electric power service also runs to the house from a power line running along the same street and possibly on the same pole line as the telephone circuit. This power line may run parallel with the telephone line for some distance, and as a result will have a certain amount of noise disturbance induced in it from the telephone line, in addition to any disturbance which may originate in the power circuit itself. The radio antenna is picking up a radio program of field intensity E, but the noise disturbance on the adjacent section of the power and telephone lines is also inducing voltages in it through the couplings that are indicated by dotted condensers on the diagram.

Of primary importance is the ratio at the radio receiver of the radio carrier intensity to the noise intensity. This ratio may be called R, and the problem is to find how the value of R is affected by the various circuit conditions indicated in Figure 1. In the first place, the strength of the radio signal in the receiver depends on the strength of the radio field, E, and on the effectiveness,  $h$ , of the antenna system in picking up the signal, which is controlled by the effective height of the antenna and impedance rela-

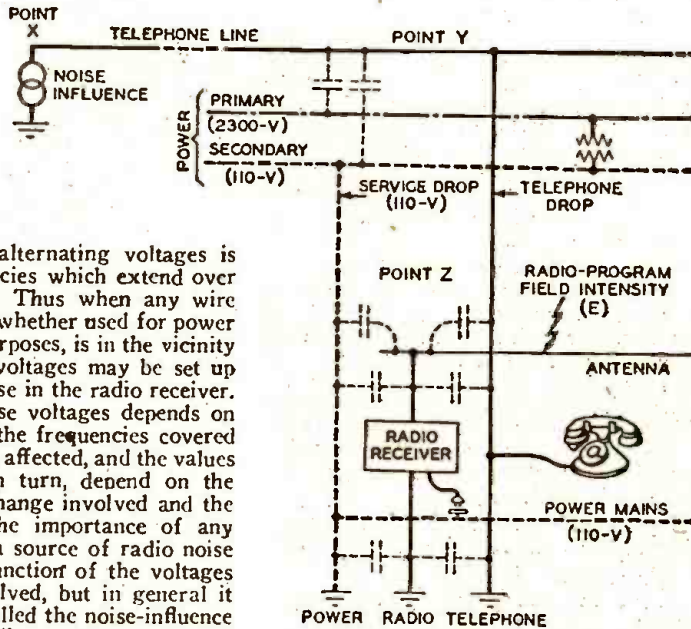

Fig. 1—Schematic representation of circuit elements involved in the transmission of noise disturbances to radio receiving antennas.

tions between antenna and receiver. If these terms were given in arithmetic units, the radio carrier voltage at the receiver would be  $Eh$ , but since it is generally more convenient to express these terms in db, the radio signal at the receiver is stated as  $E+h$ . To evaluate the strength of the noise disturbance at the receiver, it is assumed as starting out at strength NI at the central office. In passing down the line from point x to point y, however, it is attenuated by an amount that may be called "a." Expressed in db, the noise intensity on the telephone line at point y is  $NI-a$ . Between the telephone line and the receiver the noise disturbance suffers a further coupling loss, which may be designated "c." The noise intensity at the receiver is thus  $NI-a-c$ . Since all elements are expressed in db, the value of R becomes:  $R = (E+h) - (NI-a-c)$ .

As a matter of convenience, it has become common practice in laboratory studies to combine h and c in the above expression, and to denote the combination by u. With this change, and by removing the brackets from the above equation, the value of R is expressed as:  $R = E + u + a - NI$ .

A brief study of this expression will show that the best radio reception is obtained when E, u, and a are as large as possible, and NI is as small as possible. The strength of the radio field at the point of reception, E, is fixed under any given set of conditions, and while important, not much can be done locally about this factor.

The factor u is determined by the local conditions. This factor includes the efficiency of the antenna in picking up radio signals and the coupling loss between antenna and the power and telephone lines. The range

of values of u found in limited field tests is indicated in Figure 3, where the ordinates show the per cent of installations having a value of u less than the abscissa of the

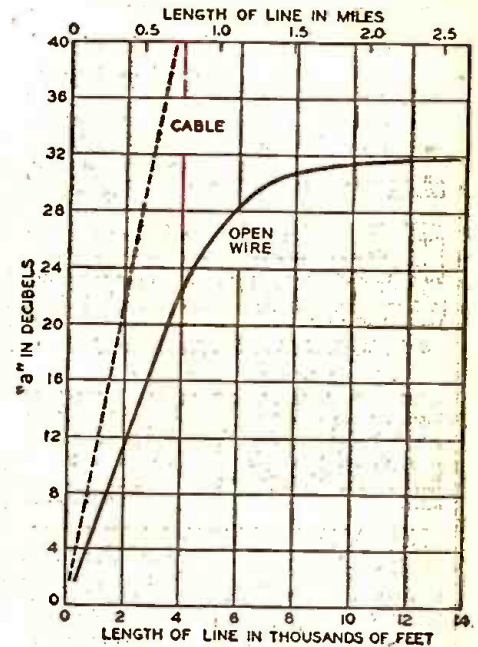

Fig. 2—Average circuit attenuation for radio disturbances (broadcast frequencies).

curve. A well-designed antenna, placed as remote as possible from telephone and adjacent power lines and with a radio-frequency transmission line from antenna to receiver, may have a u as high as 70 db. An inefficient antenna, on the other hand, closely coupled to the power and telephone lines, may have a u as low as 0 db. or less. Another factor over which a certain control

(Continued on following page)

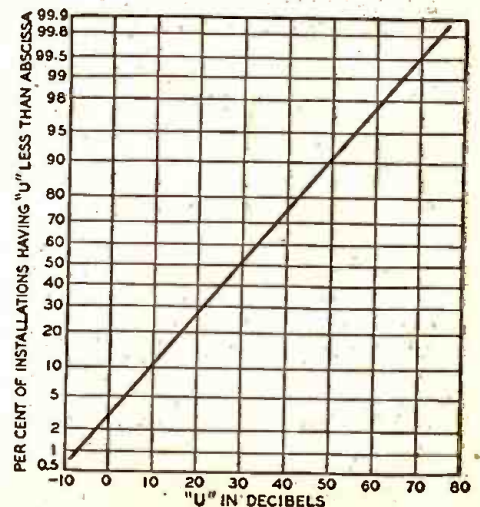

Fig. 3—Range of values of U found in various installations (broadcast frequencies).

\*Inductive Coordination Engineer, Bell Telephone Laboratories, Inc.

# AMPLIFIERS AND PARTS

GUARANTEED IN ABSOLUTE PERFECT MECHANICAL AND ELECTRICAL CONDITION, ALTHOUGH SLIGHTLY USED.

Photo shows 30 watt ampl. # 104A

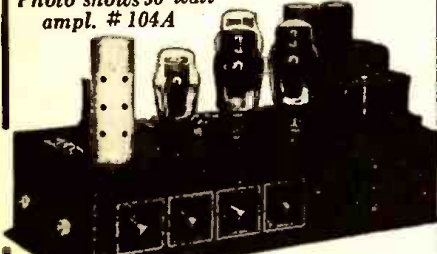

All ampl. shipped Ready to operate

# 102A—12 WATT PUSH-PULL 2A3 AMPLIFIER  
Frequency response plus or minus 2dB. from 30 to 15,000 CPS. bass and treble boost. Inputs for phono pick-up or radio tuner. Output impedance 8 or 16 ohms to P.M. or Electro-Dynamic speakers, supplies field current for one or two 2500 ohm speaker fields. An excellent amplifier for FM or recording. **\$18.45**

# 102—12 WATT PUSH-PULL 2A3 AMPLIFIER  
Same as above, but without stages of crystal pick-up. Schematic furnished free to change unit over to these stages. To be used with one or two 2500 ohm dynamic speakers 16 ohm voice coil. May be changed over to use P.M. speakers. Input for magnetic pickup. Variable tone control. **\$8.75**

Shipping Weight 25 lbs. for either of above

# 103A—20 WATT PUSH-PULL 6L6 AMPLIFIER  
Input for one crystal or dynamic microphone. Input for one crystal or magnetic phono pick-up. Full range tone control. Frequency response 30 to 10,000 CPS. Output impedance 8 or 16 ohms to FM or Electro-Dynamic speakers, supplies field current for one or two 2500 ohm speaker fields. **\$15.95**

# 103—20 WATT PUSH-PULL 6L6 AMPLIFIER  
Same as above, but without stages of crystal pick-up and crystal microphone. Schematic furnished free to change unit over to these stages. To be used with one or two 2500 ohm dynamic speakers 16 ohm voice coil. May be changed over to use P.M. speakers. Input for magnetic pickup. Variable tone control. **\$9.85**

Shipping Weight 24 lbs. for either of above

# 104A—30 WATT PUSH-PULL 6L6 AMPLIFIER  
Input for two crystal, dynamic or velocity microphones individually controlled. Input for crystal or high impedance phono pick-up. Full range tone control. Frequency response 30 to 10,000 CPS. Output impedance 2, 8, 3.2, 4, 5.3, 8 and 16 ohms to P.M. or Electro-Dynamic speakers, supplies field current for one or two 2500 ohm speaker fields. **\$21.45**

# 104—30 WATT PUSH-PULL 6L6 AMPLIFIER  
Same as above, but without stages of crystal pick-up and crystal, dynamic or Velocity Microphone. Schematic furnished free to change unit over to these stages. Has input for magnetic pickup, volume control, variable tone control. Supplies field current to one or two 2500 ohm dynamic speakers, output impedance 2, 8, 3.2, 4, 5.3, 8, and 16 ohms. Full 30 watts output. **\$12.05**

Shipping Weight 26 lbs. for either of above  
AR Amplifiers Less Tubes & Speakers.

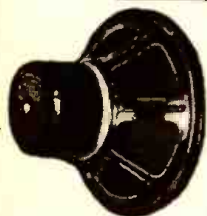

JENSEN 10 INCH  
ELECTRO-DYNAMIC  
SPEAKER

2500 OHM  
FIELD  
16 OHM  
VOICE-COIL

EACH **\$2.95**

Shipping Weight 7 lbs.

ORDERS SHIPPED SAME DAY AS RECEIVED.  
All goods are sent Express collect if no money for Parcel Post is included in remittance. Customers in Foreign countries are requested to remit in U. S. Currency or International Money Orders and include enough money to ship goods prepaid. Order from this ad. 25% deposit required on all C.O.D. orders.

PEERLESS RADIO  
AND SOUND CORP.

11 So. Desplines St., Dept. 742 CHICAGO, ILL.

## FACTORS CONTROLLING MAN-MADE RADIO INTERFERENCE

(Continued from page 687)

can be exercised is NI. Some of the steps taken by the Bell System to reduce the generation of noise disturbances by their equipment are described in the following article.

The value of "a," the attenuation along the telephone line, depends on whether the line is in cable or open wire. Figure 2 shows the general range of values as determined by field measurements. These curves represent the mean of a range of values, and irregularities have been evened out. The standard deviation of the irregularities is about 7 db. The attenuation of cable is approximately linear with distance, but that for open wire falls off rapidly after about a mile. Even where open wire is involved, however, radio reception will be some 20 to 30 db quieter at distances of a mile or more from the source of the disturbance than in its immediate vicinity.

Besides the paths along the telephone and power lines from the disturbing source to the antenna, there is also a path of direct radiation. For such a path the formula for R becomes  $R = E - E'$ , where E' is the field intensity of the noise disturbance at the antenna. Disturbances of this type become of importance only when the source is close to the antenna, such as when the noise-producing apparatus is on the same premises as the radio receiver.

Experience has shown that in many outlying districts where noise with radio reception has been reported, the chief difficulty is that distant stations are frequently sought. With field strengths of reasonable values, and with a suitable antenna circuit, preventive measures such as those described in the next article should prevent telephone apparatus from causing annoyance to radio listeners.

—Bell Laboratories Record.

## CURING INSTABILITY IN RECEIVERS

(Continued from page 652)

tube, which then shows reduced plate volts and high current.

A flat, unchanging howl or "motor-boating" are manifestations of instability which are peculiar to A.F. circuits. Again the most likely causes are open-circuited plate de-coupling components, or cathode resistor bypass condensers, or a partially open filter condenser. This latter component, if its capacity has become low, can cause most puzzling faults, ranging from an 80 per cent reduction in general performance, or perhaps whistles on all but the strongest signals, to barely perceptible "motor-boating." Also, there is never any rise in hum level, as might be expected. As a potential destroyer of performance this component is nothing if not versatile, as many servicemen will ruefully testify. Accordingly, it should be checked at an early stage.

Finally, the writer would like to repeat an axiom that is well known wherever successful radio servicing is performed. It is this: "Never take anything for granted, test it and be sure—or surprised."

—Wireless World, London.

## TRANSMITTER ADJUSTMENTS

(Continued from page 670)

completely or fairly linear. The excitation then is applied and the plate-load impedance adjusted, bearing in mind that the modulation will be more linear when the impedance is made a higher value. Power output, naturally, will suffer as the impedance is raised—but you can't have your cake and eat it too!

The grid bias is now raised until the power output drops to zero and an operating bias midway between the first and second values is chosen. The peak modulating potential for 100% modulation is then equal to ½ the difference between the bias values required for zero and peak output, and ordinarily will be approximately equal to  $E_b/2\mu$ , where  $E_b$  is the supply potential for the plate of the tube and  $\mu$  is the tube amplification factor. For linear work, however, it may be said, simply, that the tube is adjusted for Class B. With no R.F. excitation, the C bias is reduced until the tube just draws current. Then R.F. excitation is applied and increased gradually while the tank current in  $L_p-C_p$  is observed. An R.F. thermal ammeter may be connected in series with  $C_p$  for the purpose. When the D.C. plate current starts to rise without showing a proportional increase in the tank current, Class B operation has been reached. The next step is to measure the R.F. current in the load by means of a suitable R.F. ammeter having a linear scale, and to adjust the bias on the Class B tube until the load current reads ½ of its starting value. The C bias is then set correctly, provided the load coupling is correct. The D.C. plate current must be equal to the recommended value for the tube at the operating voltage. To increase or decrease the current, increase or decrease the coupling of the tube to its load circuit. To check the system approximately for linear response, shift the bias from the operating to the cut-off value a few times, adjusting the operating value until this shift in bias doubles the R.F. tank current. Now, when a sine-wave modulation signal is impressed on the grid of the tube, no carrier shift should be in evidence as the modulation percentage is increased gradually from zero to 100%.

Two carrier-shift conditions may be noticed when the gain of the modulator is brought up in cases where the circuit is functioning improperly; the first being a case where the carrier current first rises and then falls and the second being a case where the carrier current first falls and then rises. These two circuit actions can be attributed to poor regulation of the driver, in the first example, a condition that may be corrected by increasing the excitation and changing the plate-circuit load for normal plate current. The second may be corrected by checking the coupling of the modulated amplifier to its load. A good guide to proper operating conditions for the stage would be to see that the R.F. power output is about 30% of the D.C. plate input for the unmodulated condition.

In conclusion, it should be realized that much of the material on transmission is rather involved and for a more complete understanding it would be well to consult a good textbook such as *Radio Engineering* by F. E. Terman or *Communication Engineering* by Everitt.

NEXT ISSUE OF RADIO-CRAFT . . .

RADIO WAR NUMBER

# MICROTUBE TRANSMITTER

RICARDO MUNIZ, E.E., AND ARTHUR SCHLANG

**A** HAND-SIZED transmitter with a range limited enough to fall below the category of transmitters which require F.C.C. licenses and yet with a definitely reliable range has a great multiplicity of uses. The authors have made use of the transmitter described for communication between roof and indoors in installation of television antennas, between audience and stage in school "quiz" programs, and between rooms in the home and out in the fields while making tests on direction finders for communication with the target operator.

In selecting design features for the unit to be constructed the authors decided that extreme portability was to be the *Number One* essential. It was further decided that without very good fidelity the unit would fall far short of acceptability in some of the applications which were planned for it. To combine these two characteristics was indeed difficult. Only the microtube made it possible at all.

### THREE-STAGE AUDIO SYSTEM

By using microtubes a three-stage audio amplifier in extremely limited space became practicable. A voltage gain of 10,000 realized in the audio system makes possible the use of a high-fidelity brush lapel-type crystal microphone. This combination is vastly superior to any unit having similar design considerations that uses a carbon-button microphone because of a low-gain audio system.

In keeping with the use of microtubes in the audio system a midget tube of a little higher power was used in the oscillator. The National Union 1S4 tube was found to possess adequate power to reach the legal range and it was easily operated by the same hearing aid batteries as the microtubes. Although it looks like a giant alongside the other tubes it is a true midget.

### WIRING NOT CRITICAL

The wiring of the unit is not critical although the authors took the usual precau-

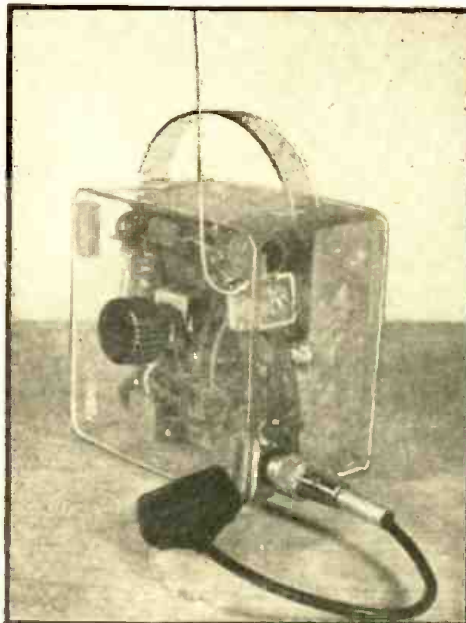

The transmitter is built into a plastic case, as shown above.

tions to assure shortest leads. The microtubes were mounted on tongues formed on the edge of the chassis by taking two closely spaced acute-angle "V" cuts. The miniature tubes were carefully wrapped in felt and attached to the tongues by gently snapping rubber bands around tube and tongue together. Keep the leads coming out of microtubes to their original length, wrapping any extra length around the tie-point, and avoid flexing at the point where the leads come out of the glass.

The audio circuit used was adapted from the hearing-aid audio circuit which comes with the microtubes. The oscillator circuit is the simple Armstrong type (using a tickler coil). The oscillator coil and condenser used is the same combination ordi-

narily used in "mystery" phono oscillators and is distributed by Eagle Radio Co., of Cortlandt St., New York City.

### AUDIO CHOKE SIZE OF LIMA BEAN

A midget audio choke is used in the plate circuit of the last audio stage in place of a resistor. This choke improves the "power" output of the amplifier materially. Since it is about the size of an average lima bean it does not add any weight or size problems.

It will be noted that the "antenna" (at these frequencies a short piece of bus is not really an antenna) is tied to the plate side of the tickler coil. This connection gives more power than connection to the grid and it also reduces the detuning effect of the "antenna."

After the unit is completely assembled and wired it should be carefully re-checked. Particularly be sure that the leads out of the microtubes are not shorted against each other. The small size of these leads makes it difficult to obtain sleeving small enough to make a neat job going over them.

### MODULATION CONTROL

The audio volume control is in reality a *Modulation Per Cent Control*. If the audio gain is turned too high a great deal of distortion due to over-modulation will result. It is best to err in the direction of having this control set too low rather than too high.

The batteries specified with the unit will last for many hours of continuous operation, since the drain is very small. The plate and screen drain on the audio system is a total of .00174 amperes and the filament drain is .08 amperes. The plate and screen drain of the 1S4 is .004 amps and its filament draws but .1 amps. The M74 microtubes operate without any filament glow whatever, so don't look for it.

The authors will be glad to hear from readers who build or contemplate building this unit and will be pleased to reply to any questions within reason which are accompanied by a stamped and self-addressed envelope.



Photograph shows Microtube Transmitter in operation.

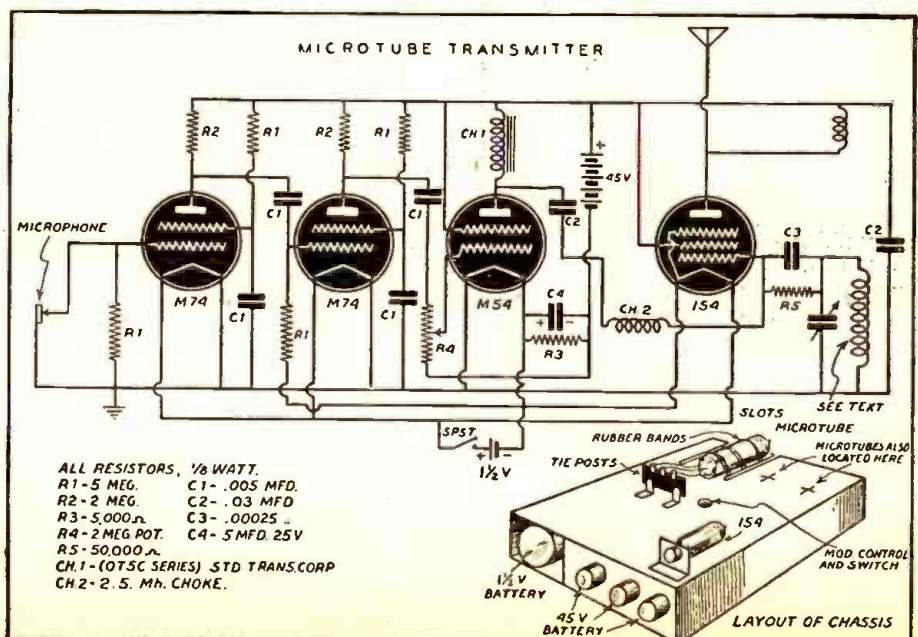

## War Speeds Radio Research and Production

Increased wartime needs will speed production of thousands of new radio transmitting tubes at Westinghouse in 1942 to help reinforce the nation's military signal communications and enlarge short wave broadcasting facilities.

Equipment for "walkie-talkie" radio stations and more than 25 different types of broadcasting tubes are now being produced for the Army, Navy and Air Corps. In the greatest expansion of radio facilities in the history of the industry, research men are working on developments which will prove as startling when peace returns as the telephone and electric light were in an earlier generation. Now enlisted for the duration, these devices, like the telephone and electric light, may some day change the mode of living for millions of Americans. Radio, first developed on a large scale as a result of military needs in the first World War, is now undergoing a second great period of research and expansion. Once again, war will probably give us new and amazing tools for peacetime jobs after victory has been won.

Compared to our present facilities, the armies of the first World War were relatively without radio "voice" or "hearing" until late in the conflict. When the United States entered the war in 1917, there were only 50 aircraft radios available and these were limited in range of communication. Today, the men who pilot America's military planes have modern transmitters which often go into action simultaneously with the pilot's guns. Voice communication, co-ordinating aircraft with ground or sea forces during actual combat are now a vital part of military tactics although radios are generally silent until the presence of the planes has been detected by the enemy.

### TANKS USE FM

Even tanks now have voice transmitters and receivers to provide greatest co-ordination of mechanized units. FM has improved tank broadcasting, further reducing the interference caused by the operation of motors and other electrical equipment. West-



Hot tongues of flame from a dozen gas jets are played on the rim of this 400-watt radio broadcasting tube as a Westinghouse craftsman seals the filament to the tube. Placed in the jaws of a glass lathe, the tube is rotated rapidly while the operator uses a small metal paddle to shape the hot glass.

inghouse is now producing many of the transmitting tubes for Army FM tank sets.

Taking a tip from the London policemen who several years ago wore tiny radio transmitters in their hats, the U. S. Signal Corps is now equipping its men with one-watt "broadcasting stations." Like walking patrol cars, parachute troops and riflemen equipped with these five-pound sets are now able to carry on conversations with their comrades two miles away.

Police patrol cars also have their counterpart in armored trucks and other motorized units which have been equipped with radio transmitters to receive and broadcast "on-the-spot" military intelligence, time signals and weather reports.

### LARGEST TRANSMITTING TUBE

For short-wave broadcasting stations fighting the Axis nations in a "war of the

air waves," Westinghouse is now producing the largest air-cooled transmitting tubes in existence. These giant tubes, cooled by airplane-type fins, consume 25,000 watts each and generate enough excess heat to keep a six-room house warm in winter.

Inside the transmitting tube, millions of electrons jog back and forth between two metal electrodes, a heated cathode and an anode, in a nearly perfect vacuum. An electrically charged grid or metal screen surrounding the cathode regulates the flow of electrons. The energy created by this electron "traffic" then sends pulsating vibrations along wires and eventually out into the air. Somewhat like the ripples started when a stone strikes the water, the radio waves shoot off the earth in ever widening waves. If they are short waves, millions of ripples or cycles (megacycles) will pass a given point every second. Standard broadcast waves are much less frequent and are measured in terms of thousands of cycles a second (kilocycles).

### WAVES ACT LIKE BOUNCING BALL

The action of nearly all radio waves in the ether resembles that of a rubber ball bouncing across a room. Vibrations shoot upward into space until they strike what is known as the Kennelly-Heaviside layer, an ionized strata of the earth's atmosphere which prevents them from rising any higher. The waves glance off this layer and bounce back to earth as far as several hundred miles away. By beaming the waves, that is, preventing them from spreading in all directions at once, short-wave stations are able to utilize the "bounce" to send strong, concentrated signals clear around the world.

Development of large air-cooled broadcasting tubes has helped to enlarge the scope of military radio communications. With air-cooled tubes, powerful stations can be set up in the field or on shipboard without the need for a steady supply of fresh water for cooling. This is particularly important for naval vessels, where fresh water is at a premium. Salt water cannot be used to cool the tubes.

## Offensive via Short Wave

CHARLES J. ROLO

Thousands of men and women in Europe are playing a dangerous game today—a game which will cost them their lives if they are caught. The game, called "Churchillism" consists of listening to British and American radio stations, Europe's only contact with the free world. Incidentally, it was the Nazis who labeled bootleg listening "Churchillism"—symbol of all they hate, fear, yet cannot crush.

U.S. and British broadcasts are the supply line through which Europe's army of intellectual guerrillas, perhaps the largest Fifth Column in the world, receives its propaganda ammunition. Words projected over the walls of Nazi censorship from London, New York, Boston, Cincinnati and Schenectady are picked up by two-man suicide squads, listening with headphones in precarious hideouts and distributing their own clandestine newssheets. There are scores of such phantom papers in occupied Europe—the *Walka* (Fight) and *Jutro* (Tomorrow) in Poland; in Belgium, the *Libre Belgique*, famous from the last war; the *Free Trade Union* in Norway; in

France, *La Résistance*, reported to have a circulation of 35,000.

Anyone caught by the Nazis relaying "foreign propaganda" is, of course, generally executed. Even just listening brings a long prison sentence. But people listen just the same—in groups before a loudspeaker, taking turns at sentry duty; in bed at night, the receiver hidden under the blankets. And what they hear travels mysteriously, by grapevine, past the long nose of the Gestapo.

Thus radio maintains contact with Europe's intellectual guerrillas; it bolsters the morale of the conquered nations, crystallizing resistance against the Axis. It foments discontent and defeatism among the enemy population, and it speaks directly to those enemy officials who may some day overthrow their own governments. Significantly, allied intelligence reports reveal that a large number of Nazi and Fascist officials are now regular listeners to British and American stations. Radio is indeed the "fourth arm" of the allied war effort.

Not long ago, U.S. short-wave listeners heard from Tokio, via Radio Ankara, that

Hitler is a Moslem, a direct descendant of the Prophet, born with the sacred green belt around his middle.

The same day, Faud Muffarij, Arabic announcer of station WRUL in Boston, exposed Tokio's fable by rattling off the choicer insults levelled at Moslems in *Mein Kampf*.

Proof of the success of what Dr. Goebbels complained bitterly of as "the psychological invasion of the Continent by the American radio" regularly slips through the cracks in the walls of Nazi censorship to the outside world—sometimes in strange and devious ways. The pains taken by the Nazis to "jam" British and American programs is one indication that these broadcasts are hitting where it hurts. Another is the Nazis' attempt to confiscate all receiving sets in Poland and in parts of Norway. But most convincing of all are letters which, for the past two years, have poured into the studios of American stations, and which, despite a vigilant Gestapo, continue to filter through with the message: "We're listening."

—Coronet, Chicago.

**STATIC IN CAR RADIOS  
TRACED TO TIRE FRICTION**

(Continued from page 671)

ably due to a progressive drying out of the road surface as road temperature increased.

"Over as small a distance as 0.5 mile on a uniform pavement, fluctuations in the car potential as large as 1,000 or 2,000 volts were often recorded. These observed fluctuations lend support to the previously mentioned theory that radio static depends on fluctuations in the rate of charge generation by the tires."

The problem of shock hazard to a passenger leaving or entering a motor vehicle depends upon the potential retained on the vehicle after it stops, tests show. The steps taken to reduce tire radio static by reducing the potential generated by the tires therefore also reduce the shock hazard. Tires having a low rim-to-tread resistance would be especially effective in reducing the danger of electrical shock, it is declared.

"In addition, it is obvious that artificial means of grounding the car upon stopping would eliminate the danger of shock. For example, some toll bridges are provided with flat springs projecting through the pavement which make contact with the car as it stops before the toll-house.

"The problem of electrical shock is especially important to aviation transportation. It is well known that the potential gradient near the earth's surface is 60-300 volts per meter, and that in flight an airplane eventually acquires the same potential as the surrounding atmosphere. Upon landing, the airplane might therefore be at a high potential with respect to the ground. To permit the airplane to be brought back to ground potential before the passengers step out, highly conducting tail-wheel tires have been developed."

**HOW WPB TUBE CURBS  
MAY AFFECT SERVICEMAN**

(Continued from page 657)

types discontinued by the order, which tubes were associated with RCA types through RCA double-branding arrangements. Where a direct RCA renewal type is available for a discontinued type, the information is shown in the table. Where a direct renewal type is not available, a "possible" renewal type is suggested. This renewal information will be of help when stocks of the types discontinued by the W.P.B. order are exhausted. Total present inventories of these types, taken on an average basis, have been estimated to be sufficient to take care of renewal needs for about two years.

It will be noted from the table below that 95 tubes are directly replaceable by existing tube types. References to necessary changes for other discontinued types are indicated as footnotes to which the key numbers apply.

**MAKE A FLUORESCENT  
DISPLAY**

(Continued from page 655)

small types. For this reason the new 14-watt, 15" (a T-12) was found very adaptable to this circuit. A preferred resistance value is 210 ohms.

The wattage is a little high for a line cord and the latter must be operated in open air and must not be concealed. The cord becomes quite warm, causing the resistance to increase so that difficulty may be experienced in starting the tube immediately, after it already has been operating. If this condition is too pronounced, the resistance of the cord may be reduced by clipping off a small portion, but it should not be reduced much below 150 ohms, this to be read when cold.

**OCTAL SOCKETS HOLD LAMPS**  
The only remaining parts needed are lamp holders, and these were found in a pair of old octal tube sockets. The prongs of the fluorescent are the same size as those of an octal tube and the spacing is such that they fit into alternate holes. The socket is mounted by cutting out and bending down a lip on the end of the reflector. This permits enough spring tension to permit installing the tube without taking off one socket.

**REFLECTOR MADE OF SCRAP METAL**

The reflector is made of any piece of scrap metal 24" x 8" bent to any desired angle 3" from each edge. The inside should be painted white. Two or more lamps may be used, but each will require an individual circuit. No success has been had starting two lamps on one circuit because one lamp starts at a time and then reduces the voltage so that the other will not start.

Radio interference is bad with all fluorescent lights and its elimination requires shielding of all wires, condensers from line to ground and all other precautions. Regular mesh shielding may be slipped over the line cord if interference is too bad.

The lamp in the resistive circuit works well on D.C. It is 100% power factor, or as near so as the tube permits.

Quite an attractive window display can be made by soldering a strand of wire to one prong of each end of a tube and suspending it from these wires. If fine wire is used the first impression will be that the tube is burning in midair without any support. We have found people stopping their automobiles to examine this display.

Starting the tube is accomplished by shorting across the free prongs for a few seconds and then removing the wire. The line cord can be moved out of sight so that only the burning tube and the fine wires are visible, the latter only on close inspection.

**RADIO COMMUNICATION  
COURSES**

**QUALIFYING FOR ALL  
FEDERAL LICENSES**

**RESIDENT and HOME STUDY**

**WRITE FOR FULL PARTICULARS**

**AMERICAN RADIO INSTITUTE**

1123 BROADWAY

NEW YORK

**YOU MAY NEVER AGAIN  
HAVE THIS  
OPPORTUNITY**

Here is a real opportunity! Radio Code Operators are in demand right now . . . You can have a real place with the Army, Navy, Merchant Marine, or in civilian industry. It's easy to learn to be a Radio Code Operator without leaving your own home . . . You can learn by the Candler System and take advantage of their quarter of a century of success. The Candler System shows you all the short cuts . . . It's easy and very practical. Thousands of successful Candler graduates attest to its thorough teachings . . . find out today, a post card will do—no salesman will call upon you . . . Send a post card NOW!

**YOUR FREE BOOK**

Candler's FREE BOOK OF FACTS is waiting for you—send for your copy today! Find out all the inside facts about learning radio code or boosting code proficiency. It's a fascinating story—Write for your copy today! . . . There's no obligation.

**CANDLER  
SYSTEM CO.**

Box 928  
Dept. 5-7, Denver, Colorado



**LEARN RADIO**

**TELEVISION**

600 LICENSED graduates placed in past 7 years in shipping, broadcasting, aviation, police, etc.; we also teach radio servicing and repairing; new beginners' class forming Sept. 8th; 60-page catalog free; oldest, largest and best equipped.

**MASS. RADIO SCHOOL**

18 BOYLSTON ST., BOSTON, MASS., Est. 1899

**CHECK HERE!**

—If you want a BETTER radio job! Your radio experience backed by CREI modern technical training will equip you to share in the better, good-paying jobs that await trained men. Technical ability is the only thing that stands between you and a better job NOW and a secure radio career in the future. Write for FREE BOOKLET and details. **CAPITOL RADIO ENGINEERING INSTITUTE, Dept. RC-7, 3224 16th St., N.W., Washington, D. C.**



# A SLIGHT DISAGREEMENT WITH OPA

Suggestions on the war-time care of radios, released by the Office of Price Administration, have been thoroughly publicized through the press and by radio broadcast. It is important that all servicemen become familiar with them. Practical experience and familiarity with the most efficient methods of servicing home radios may suggest some differences of opinion.

R. S. Merkle presents a page from his own experience as a practical radio serviceman in repairing a simple defect—a shorted filter condenser. If it is repaired in the living room, the housewife will be annoyed to find a service kit open and tools spread out; the cabinet pulled into the middle of the floor, or perhaps upside-down. Off to one side will be a pile of knobs, and another of chassis bolts, rubber bushings, and a set of tubes. There will be a soldering iron heating up, which no doubt will burn a hole

in the rug or drop solder on the varnished floor. At some other place in the room will be the chassis, with a two-foot-square analyzer. After the serviceman has found the defective condenser and unsoldered it, making a disagreeable odor, he discovers that he does not have the right replacement unit in his service kit. He rushes back to the shop, leaving this junky mess all over the room, and returns in due time to find the customer's afternoon bridge club standing around in bewilderment. He then fumes and

sweats over the job while he answers a thousand questions from the ladies, who feel that they know a great deal about the proper way to repair a radio set, and might as well learn all about it. That, briefly, is the story of one actual minor repair done in the home.

Another point is that under present conditions most servicemen have more work than they can do, and in many cases will soon be using youngsters, or even women to pick up sets and bring them to the shop. This will allow the trained and competent servicemen to use his time where it is of the greatest value—at his work bench.

## Lowest Priced Publications for Experimenters

10 FOR 50c

Here is a large number of radio, short-wave, and mechanical "how-to-make-it" designs. Each is a special publication originated by masters in their respective fields. For the low price of 50 CENTS, you buy TEN complete pamphlets with photographic reproductions, complete mechanical layout, and full description to make it possible for anyone to build the project in question.

PLEASE ORDER EACH PROJECT BY ITS PUBLICATION NUMBER, and use the special coupon below. We accept money-orders, cash, checks or new U. S. stamps. (No foreign stamps.) If you send cash or stamps, register your letter. Money refunded if you are not satisfied. ANY TWENTY-FOUR PUBLICATIONS FOR ONE DOLLAR.

### SHORT-WAVE RECEIVER PUBLICATIONS

- HOW TO MAKE THE "OSCILLODYNE" 1 TUBE WONDER SET.....No. 101
- HOW TO MAKE THE "19" TWIN- PLEX (ONE TUBE PERFORMS AS TWO) RECEIVER.....No. 102
- HOW TO MAKE THE WIZARD 1-TUBE 50-WATT TRANSMITTER.....No. 103
- HOW TO MAKE THE IMPROVED 3-TUBE DOERLE SET FOR BATTERY OPERATION.....No. 104
- HOW TO MAKE THE "GO-GET-EM 2" RECEIVER FOR THE BEGINNER.....No. 105

- HOW TO MAKE THE 1-TUBE-ALL-ELECTRIC OSCILLODYNE.....No. 106
- HOW TO MAKE THE 2 TO 5 METER TWO-TUBE LOUDSPEAKER SET.....No. 107
- HOW TO MAKE THE 3-TUBE BATTERY SHORT-WAVE RECEIVER.....No. 108
- THE BRIEF-CASE SHORT-WAVE RECEIVER AND HOW TO BUILD IT.....No. 109
- HOW TO BUILD THE POCKET SHORT-WAVE RECEIVER.....No. 110
- HOW TO BUILD THE CIGAR-BOX 1-TUBE "CATCH ALL" RECEIVER.....No. 111

- HOW TO BUILD THE "DUAL-WAVE" SHORT-WAVE BATTERY RECEIVER.....No. 112
- HOW TO BUILD THE 1-TUBE "53" TWINPLEX" RECEIVER.....No. 113
- HOW TO BUILD THE PORTABLE MINIDYNE SHORT-WAVE BATTERY SET.....No. 114
- HOW TO BUILD THE HAM-BAND "PEE-WEE" 2-TUBER.....No. 115
- HOW TO BUILD THE DUO-AMPLIDYNE.....No. 116
- HOW TO BUILD THE "MOND-COIL 2".....No. 117

### RADIO BROADCAST RECEIVER AND SPECIAL RADIO PUBLICATIONS

- HOW TO MAKE THE A.C.-D.C. "CASH BOX" RECEIVER.....No. 118
- HOW TO MAKE BEGINNER'S 2-TUBE ALL-WAVE SET.....No. 119
- HOW TO BUILD THE "RADIO-LAMP" 4-TUBE TABLE RECEIVER.....No. 120
- HOW TO BUILD A SUPER-SENSITIVE ALL-WAVE CRYSTAL SET.....No. 121

- HOW TO BUILD THE 2-TUBE "PENTODE PORTABLE" BROADCAST SET.....No. 122
- HOW TO BUILD THE RADIO "TREASURE" FINDER.....No. 123
- HOW TO BUILD THE GERNS-BACK ONE-TUBE PENTODE LOUDSPEAKER SET.....No. 124
- HOW TO BUILD THE WORLD'S SMALLEST ONE TUBE BATTERY RADIO.....No. 125

- HOW TO BUILD A 6-TUBE BATTERY ALL-WAVE "FARM PORTABLE" SET.....No. 126
- HOW TO MAKE AN A.C.-D.C. ONE-TUBE "DEAF AID".....No. 127
- HOW TO BUILD A PIANOTRON.....No. 128
- HOW TO BUILD THE ONE-DOLLAR RADIO.....No. 129
- HOW TO MAKE A VARIABLE-TONE CODE PRACTICE SET.....No. 130

### MECHANICAL PROJECTS PUBLICATIONS

- HOW TO MAKE A SOUTH SEA OUTRIGGER CANOE.....No. 131
- HOW TO BUILD A PEE-WEE AUTOMOBILE.....No. 132
- HOW TO BUILD A DUAL-CONTROL GLIDER.....No. 133
- HOW TO BUILD A HOUSEBOAT ON PONTOONS.....No. 134
- HOW TO MAKE A BAND SAW FROM OLD AUTO PARTS.....No. 135
- HOW TO BUILD A REAL LATHE FOR \$5.00.....No. 136
- HOW TO BUILD A SAIL CAT-BOAT.....No. 137

- HOW TO BUILD A SIMPLE PORTABLE REFRIGERATOR.....No. 138
- HOW TO BUILD A XYLOPHONE.....No. 139
- HOW TO BUILD THE ROWMDBILE.....No. 140
- HOW TO BUILD LARGE TESLA AND OUDIN COILS GIVING 18-INCH SPARKS.....No. 141
- HOW TO MAKE AN ARC WELDER.....No. 142
- HOW TO USE AN A.C. ARC WELDER.....No. 143

- HOW TO MAKE YOUR OWN MICROSCOPE.....No. 144
- HOW TO MAKE A WIMSHURST ELECTROSTATIC MACHINE.....No. 145
- HOW TO MAKE A POWER DRILL PRESS FROM SCRAP PARTS.....No. 146
- HOW TO BUILD A GOOD LATHE FOR \$1.00.....No. 147
- HOW TO MAKE AND EXPERIMENT WITH AN ELECTROPHOROUS.....No. 148
- HOW TO MAKE AN ELECTRIC ARC WELDER FROM AN AUTOMOBILE GENERATOR.....No. 149

**RADIO PUBLICATIONS, 25 West Broadway, NEW YORK, N. Y.**

**RADIO PUBLICATIONS, 25 West Broadway, NEW YORK, N. Y. RC 7**

I enclose \$.....for the publications listed by number, at right, at the rate of 50c FOR ANY TEN PUBLICATIONS. NO ORDER FOR LESS THAN 50c ACCEPTED. \$1.00 for 24 publications. These publications are to be sent to me postpaid. I have placed a circle around each number which I want.

Name .....Address .....  
City .....State .....

101	102	103	104	105	106
107	108	109	110	111	112
113	114	115	116	117	118
119	120	121	122	123	124
125	126	127	128	129	130
131	132	133	134	135	136
137	138	139	140	141	142
143	144	145	146	147	148
					149

### OPA TELLS RADIO OWNERS

1. Make sure that the radio is not placed with its back flat against the wall. Tubes, transformers and resistors heat up, and free circulation of air is required to prevent overheating. Leave an inch or so between the cabinet and the wall.
2. Check the set's electric cord and plug. The plug should fit firmly into the wall socket and the wires leading to it should be intact.
3. Check connections also on nearby electrical appliances and lamps. Loose connections on nearby gadgets cause static. Sometimes moving an appliance or lamp farther away will help reception.
4. If the radio crackles, check the aerial and ground wires to determine whether they are broken in any place, or are rubbing against other wires or trees or metal.
5. If you have not set up a ground connection and your radio is noisy, fix one up by connecting a wire from your radio's ground post to a water or steam pipe. Do not use your gas pipe as a ground.
6. If you have an outside aerial, make sure that it is equipped with a lightning arrester. Even small "static discharges"—not lightning—may ruin a set unless they are by-passed by the arrester.
7. Check the set's tubes, to see that they fit firmly in their sockets. Occasionally what may seem to be a bad tube is merely a good tube that is fitted loosely into its socket.
8. Clean the dust out of your set often. A hand vacuum cleaner will help.

If your radio's performance is unsatisfactory, and none of these home adjustments help, it's time to call in the repairman. These points should be observed:

- (a) Call in a repairman from a reputable firm—one with which you are acquainted, if possible.
- (b) Insist that he fix the set at your home. Most service firms have portable testing and repair equipment for home calls.
- (c) If he insists on carrying the set to his shop, persuade him to give you an inventory of the adjustments he thinks will be necessary, and request the return of old parts which he finds it necessary to replace.—*Sylvania News.*

**DYNAMOTORS**

(Continued from page 681)

an insulating technique which permits the use of a special grade of insulation between the windings of the armature. This makes practically impossible a failure between armature windings. Formex wire, noted for its fine insulating properties, is used in both the high and the low-voltage windings.

Since weight considerations are of vital importance in aircraft, tanks and mobile field equipment, these dynamotors are designed and built to save weight wherever possible and are extremely light and compact. They have the ability to stay on the job without attention for long periods under extremely rigorous and unfavorable conditions. This characteristic is of the utmost importance in all types of communication service, particularly in military equipment.

These dynamotors, which are made in five different sizes having intermittent-use ratings of from 25 to 600 watts, keep alternating-current ripple at a value which requires a minimum of filter to provide satisfactory operation of the communication equipment. Dynamotor commutators are carefully built and undercut. Brushes and brush pressures are controlled so that commutation will meet rigid standards.—*Radio-Craft*

**LOW-LOSS MOLDED LOCK-IN TUBE SOCKET**

A. W. Franklin Mfg. Corp.  
175 Varick Street  
New York, N. Y.

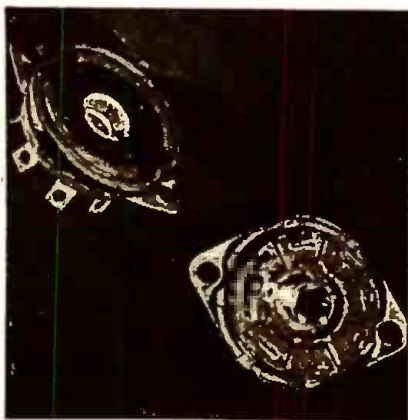

**T**HIS low loss socket of the "lock-in" type for special applications for Army and Navy work has a molded shell of mica-filled low-loss phenolic material for operation at higher frequencies.

Contacts are claimed to be of revolutionary design and free from the inherent weaknesses, allowing thousands of insertions and rotation of tubes without contact failure. If, through abuse, a contact is distorted, it is merely necessary to force the contact tail sideways several times and the contact is restored to its normal contour which exerts initial electrical and mechanical contact to tube pin. This is one of the many features which makes this socket superior to all others, according to the manufacturers.

The top plate is of XXX Laminated stock or X2B Hard Rubber and securely locked to shell by a brass, heavily silver plated center piece. The locking spring is made of 18-8 Stainless Steel and affords the required tension to maintain the tube in position during severe vibration tests. The mounting shell is of heavily nickel-plated brass, and it permits the socket to be mounted on top of chassis with screws or rivets.—*Radio-Craft*

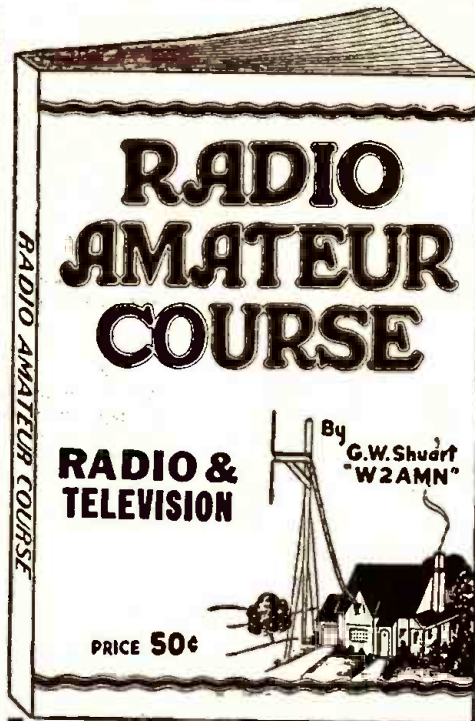

**148 PAGES**  
6 x 9 INCHES  
**OVER 150 RADIO DIAGRAMS**  
**and TECHNICAL PHOTOGRAPHS**  
**RADIO AND TELEVISION**  
25 West Broadway New York, N. Y.

**DECADE VOLTAGE DIVIDER**

Shallcross Mfg. Co.  
Collingdale, Pa.

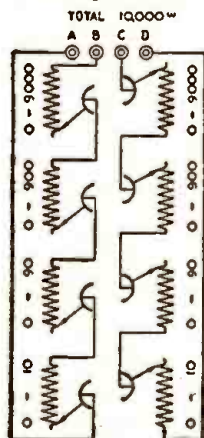

**C**ONTINUING its policy of making equipment to fit each specific job rather than supplying a standard device to attempt to handle all cases, Shallcross an-

**TECHNICAL REVIEW OF CATALOGS**

**NEW OHMITE CATALOGUE**

A new stock catalogue which is believed to be particularly useful because many emergency requirements can be met by the use of stock units, has been issued by Ohmite Manufacturing Company.

Catalogue 18 has been published with the aim of being helpful to users of rheostats and resistors.

Besides the units listed in the catalogue, Ohmite makes many special rheostats, resistors, chokes, switches and mountings, and offers co-operation and engineering

**Your Money Back—**

If the **RADIO AMATEUR COURSE** does not represent the greatest book value ever offered to the radio "fans" for ..... **50c**

**T**O convince you that there isn't a better book buy today, the publishers of the **RADIO AMATEUR COURSE** make the sensational offer of a money-back guarantee on such a low-priced book. Stop in at any of the many dealers handling this book and examine it. See for yourself if the **RADIO AMATEUR COURSE** isn't just the book you've always wanted.

Printed on the finest coated paper—well illustrated attractive 4-color cover—complete with radio information you must have. It contains a step-by-step program for obtaining a short-wave radio education.

Written by **George W. Shuart, W2AMN**  
foremost short-wave authority

**RADIO AND TELEVISION**  
25 West Broadway, New York, N. Y.

Gentlemen: I enclose herewith my remittance of Fifty Cents (50c) for which please send me **POST-PAYED** my copy of the **RADIO AMATEUR COURSE**. (Remit by check or money order; register letter if you send cash or unused U. S. Postage stamps.)

Name .....

Address .....

City ..... State ..... RC-7-42

nounces that it is now ready to furnish Decade Voltage Dividers in any capacity and calibration desired.

Due to the standard design of the Shallcross rotary instrument switches and Decade Resistance Boxes this flexible arrangement is practicable. Any desired series of Decade Voltage Dividers is readily arranged, having a constant internal resistance.

The diagram shows a set-up having four dials. The resistance "AB" and "CD" may be used independently (as a resistance box). When the dials are rotated clockwise, resistance "AB" will be increased and resistance "CD" will be decreased.

When used as a Voltage Divider, a link (provided with the set) is placed across "B" and "C". This makes the resistance "AD" constant at all settings of the dials.

These adaptable and precise Decade Voltage Dividers should prove to be valuable instruments in experimental, research and routine work involving calibration of galvanometers and voltmeters and in other measurements of high resistance.—*Radio-Craft*

facilities for meeting emergency needs.—*Ohmite Manufacturing Company*

**MANUAL ON G.E. TUBES**

A 24-page technical manual on G.E. radio receiving tubes, prepared to assist those who work or experiment with radio tubes and circuits, has been released by the Renewal Tube Sales Section of the General Electric Radio Television and Electronics Dept., Bridgeport, Conn. The manual can be obtained by radio Servicemen, radio technicians, experimenters, radio amateurs, and others technically interested in radio tubes by writing to the G.E. department.

I pay cash for all used Communication RECEIVERS  
Send me a description of what you have to offer.

We have a large stock of . . .

**HALLICRAFTERS**  
**HAMMARLUND**  
**RME**  
**HOWARD**

**RECEIVERS**, transmitters and all radio supplies of all sorts at lowest wholesale prices. Order from us for immediate delivery. We specialize in Government and other priority orders and solicit such buyers, as well as civilian and all other customers.

- YOU get 10-day trial
- YOU get best trade-in

We also have a store at 2335 Westwood Blvd., West Los Angeles, Calif. Write, fone, telegraph us anytime about any radio supplies. It will pay you to deal with us. Your inquiries invited.

I pay cash for all used Communication RECEIVERS  
Send me a description of what you have to offer.

**HENRY RADIO SHOP**  
Butler, Missouri  
"World's Largest Distributors of Communications Receivers"

## Diagrams for The Radio Experimenter

This is a new department. If you have a new Hook-Up, send it along; a pencil diagram will do. Be sure to include a brief description. All diagrams and descriptions accepted and published will be awarded a year's subscription. Diagrams may be for receivers, adapters, amplifiers, etc. Send them to Hook-Up Editor, RADIO-CRAFT, 25 W. Broadway, New York City.

### AN ALL PURPOSE 12-WATT AMPLIFIER

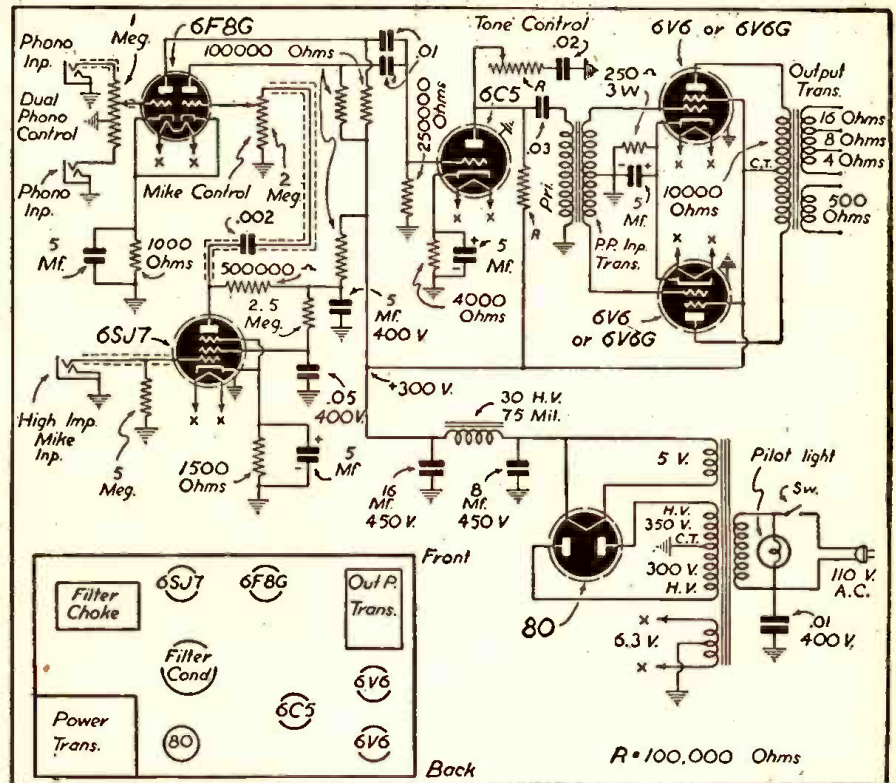

I am enclosing my diagram of a 12-watt hi-gain amplifier which I designed. This is an all-purpose amplifier built at an exceptionally low cost. With the parts on hand I built it for only \$6. Anyone may duplicate it for \$15 to \$20, excluding the microphone, phonos, and speakers. The voltage amplifier has sufficient gain

to drive the output stage well up to a 15-watt peak. Three inputs are provided: Two for phonographs with a fader control, and one for a high-impedance crystal, dynamic, velocity, or other microphone with a low output. The parts are standard and are very

(Continued on following page)

## SPECIAL

**ABC OF TELEVISION**  
Contains latest material on Television developments. It covers theory of scanning; simple television receiver; how the eye sees; the photoelectric cell; neon lamps; electric cell; broad channel width; transmission of high-fidelity television signals; cathode ray tube; and television receivers. Farnsworth system of television transmission, and other important features.

**SHORT WAVE GUIDE**  
Covers hundreds of short-wave questions and answers; illustrates popular short-wave kinks; gives explicit instructions for building simple short-wave receivers; instruction on the best type of antenna installation; diagram and details for building transmitters.

The books listed below have never been sold by us before. The value of each book is 50c. They are exactly the same as RADIO & TELEVISION'S 50c blue books which have been on the market for years. For a short time only we are selling these at a special reduced price of only 75c for the 3 books. All of the books contain numerous photographic illustrations and diagrams and have stiff flexible cover.

**S. W. RADIO QUIZ BOOK**  
This book covers questions and answers on transmitters, ultra short-wave receivers, practical kinks, wrinkles and coil winding data; novel hook-ups for experimenters; how to "hook-up" converters, noise eliminators, power supplies, modulators, beat oscillators, 5-meter receivers, selectors.

**RADIO & TELEVISION**  
25 W. Broadway,  
New York, N. Y.  
Gentlemen:  
Enclosed you will find remittance for 75c (cash, now U. S. stamps or money order accepted) for which please send me at once your 3 books  
**ABC OF TELEVISION** **SHORT WAVE GUIDE**  
**SHORT WAVE RADIO QUIZ BOOK**

Name .....  
Address .....  
City ..... State ..... RC. 7-42



easily obtained from any radio-supply store or mail-order house. I am using as a power transformer a Thordarson unit giving 350 volts at 90 mils and 5 volts at 3 amperes for the rectifier (although 2 amps would be sufficient) and 6.3 volts at 2.5 amps for all other heaters. Any other similar transformer would be suitable. The push-pull input audio transformer is a standard 3:1 type. The output transformer has a 10,000-ohm primary, center tapped, and a universal secondary with a 500-ohm line winding.

All the resistors except the 250-ohm bias resistor on the output stage may be the small 1/2-watt type. All the condensers except the filter and cathode condensers should be rated at 400 volts working voltage or more. The cathode condensers are the standard 35 mf.-50 volt electrolytics. The filter condensers are one 8 mf. 450 volt and one 16 mf. of the same voltage rating. This supplies adequate filtering, along the 30 henry 75 mil. choke.

In the high-gain hookup of the 6SJ7 very careful arrangement of parts must be made and all grid and plate leads should be shielded and the shielding grounded to prevent hum pickup. Unless this is carefully done, the hum will be very bad. The volume control for the mike is on the grid of the next stage, so as to prevent the high gain hum pickup from being amplified.

All input jacks should be shielded and should be closed-circuit jacks to ground the grids when no input is connected. A tone control is provided by a 100,000-ohm potentiometer and a .02 mf. paper condenser.

All metal tubes should have their shells grounded. It is a good practice to shield the 6F8G tube.

When mounting the parts, the power transformer should be first mounted on a corner of the chassis. Then connect the secondary of the audio transformer to an amplifier and mount it where the hum pickup is least. This is usually under the chassis in the far corner from the power transformer. The output transformer should then be mounted on the top of the chassis, quite a distance from the power transformer. Below is the placement I used and found to be very satisfactory. The chassis is a 9 x 7 x 2 inch steel one.

I have my controls extended to a control panel and the amplifier in a 10 x 7 x 7 inch well ventilated cabinet. All the controls and wires to them should be well shielded to reduce hum.

If you follow carefully these instructions and the accompanying diagram, you will be rewarded with a very versatile, universal, high-gain, good quality, 12-watt public address amplifier.

You can very well run a 12-inch permanent magnet dynamic or two 8-inch speakers, or a number of smaller ones from this amplifier.

Roger Harrington,  
Buffalo, N. Y.

S-W RECEIVER

Above you will find a diagram which I believe will be of interest to your readers.

I have experimented with various circuits for a long time, but I could not find one that would regenerate satisfactorily on 20 meters. I had nearly given up hope when I thought of designing a circuit with dual regeneration. I put a potentiometer in the screen-grid circuit of the 6J7 and a variable condenser in the plate circuit for regeneration. The screen voltage is quite critical for certain combinations but this circuit provides a means of selecting the screen voltage which will make the set the most selective.

RADIO-CRAFT for JULY, 1942

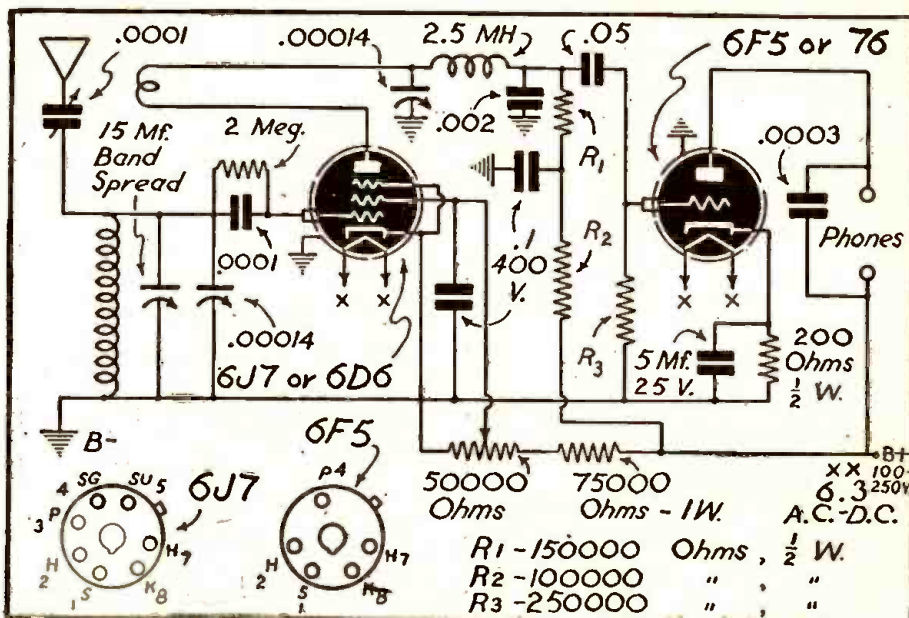

S-W Receiver

FREE!

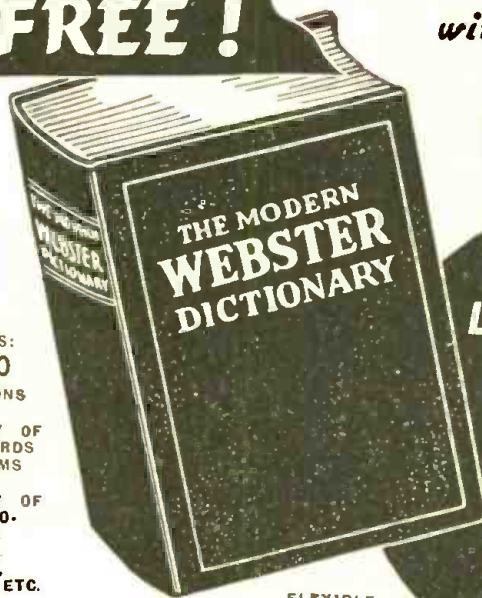

CONTAINS:  
22,000  
DEFINITIONS  
•  
DICTIONARY OF  
RADIO WORDS  
AND TERMS  
•  
DICTIONARY OF  
THE AUTO-  
MOBILE  
•  
TABLES,  
TREATISES, ETC.

FLEXIBLE  
IMITATION  
LEATHERETTE  
COVER, SIZE 5 1/2"x8"

with \$1.00 subscription  
to  
RADIO-CRAFT

FULL  
LIBRARY SIZE  
MODERN  
WEBSTER  
DICTIONARY  
416  
PAGES

FILL OUT-MAIL THIS COUPON TODAY!

RADIO-CRAFT, 25 West Broadway, New York, N. Y.  
 This is a New Order  Extend my present subscription  
 Gentlemen: Enclosed you will find One Dollar for which enter my subscription to RADIO-CRAFT Magazine for Eight Months. Send me, ABSOLUTELY FREE and POST-PAID, my copy of the MODERN WEBSTER DICTIONARY.  
 Name .....  
 Address .....  
 City ..... State .....  
 RC-7-42  
 (Remit by check or money order; register letter if you send cash or unused U.S. Postage Stamps)

RADIO-CRAFT  
25 WEST BROADWAY NEW YORK CITY

Inventions Wanted  
Patented or Unpatented

We have been successfully selling inventions, patented and unpatented, since 1921. Write us, if you have a practical, useful idea for sale.  
 CHARTERED INSTITUTE  
OF AMERICAN INVENTORS  
Dept. 109 Barrister Building, Washington, D.C.

PATENTS—TRADE MARKS

Booklet concerning Inventions & Patents Form "Evidence of Conception" with instructions for use and "Schedule of Government and Attorneys Fees"—Free  
 LANCASTER, ALLWINE & ROMMEL  
 Registered Patent Attorneys  
 436 Bowen Bldg. Washington, D. C.

It regenerates on all bands down to 16 meters. This set will bring in foreign stations with good car-phone volume. It was designed especially for short-wave use. I-

am sure that every experimenter will find this circuit useful.

WILFRED CIELUCH,  
New York, N. Y.

# A New Type of Service Manual!

## RADIO CIRCUIT MANUAL — 1941

**The Only EDITED Manual  
Ever Published!**

**DIRECTORY OF RECEIVERS MANUFACTURED IN 1940 AND UP TO JUNE, 1941**

### MORE INFORMATION IN HALF THE NUMBER OF PAGES

The value of a service manual is measured not by the number of pages but by the amount of useful information. Thus, in only 736 pages this Radio Circuit Manual covers over 200 receiver models MORE than does any other competitive manual in twice the number of pages.

HOW DID WE DO IT? . . .

. . . By increasing the size of our page; by discarding non-essential data and editing the balance; by listing only those receivers which the Service Engineer will definitely have to repair (no communications or export receivers, no shortwave sets or amplifiers, no electronic devices, etc.); by many months of hard work based on a definite plan of procedure and a clear understanding of the actual requirements of the Service Engineer. There is no "dead weight" information to add bulk to this Manual. Every word counts. Every minute of reading time is well spent.

### OUTSTANDING FEATURES

- Contains data on more than 1800 receiver models—more than any other radio service manual.
- Only 736 pages!—less than half the bulk of any other manual and more than 1/3 lighter.
- All information is EDITED!—all non-essential data deleted and the balance checked and correlated with the schematics and sketches.
- 40% larger page permits listing of all information on one page. (A few unavoidable cases excepted.)
- I.F. peaks for all superhet circuits are boldly displayed in black boxes;—none missing, all accurate.
- No space wasted on communications and export receivers, amplifiers, electronic musical instruments, etc.—a 100% Service Engineer's Manual.

### A "CUSTOM-TAILORED" MANUAL FOR SERVICE ENGINEERS

Here, at last, is a Service Manual deliberately PLANNED for the Service Engineer. Instead of a mere hodge-podge collection of service data, as manuals have been in the past, this RADIO CIRCUIT MANUAL is an orderly compilation of essential radio diagrams and service information, carefully edited and uniformly presented for the maximum convenience of the busy Service Engineer. All time-consuming, non-essential data have been weeded out, and the remaining information, vitally important to the rapid and efficient servicing of modern radio receivers, has been laid out in a logical, easy-reading style which cuts time from the day's work. Because of this and other features which are self-evident upon first observation, it has been possible to list all information pertaining to a given model on a single page.

In 736 pages this Manual presents essential service data on over 1800 receiver models;—more than any other existing service manual on the market!

### ONLY ONE MANUAL PER YEAR!

The new technique used in compiling this RADIO CIRCUIT MANUAL—1941 makes it possible to include in a single book all the new receiver models which the radio industry can produce in a single year. This factor alone represents an important saving to all Service Engineers.

### A PERMANENT INSTITUTION

This Radio Circuit Manual—1941 is NOT a one-time proposition. Next year there will be a Radio Circuit Manual—1942, the following year, 1943 and so on indefinitely—each Manual better than the other as new methods are worked out for expediting and simplifying the work of the practicing Service Engineer.

ONLY  
**1000**

**RADCRAFT PUBLICATIONS, INC.**  
25 WEST BROADWAY NEW YORK, N. Y.

RADIO-CRAFT for JULY, 1942

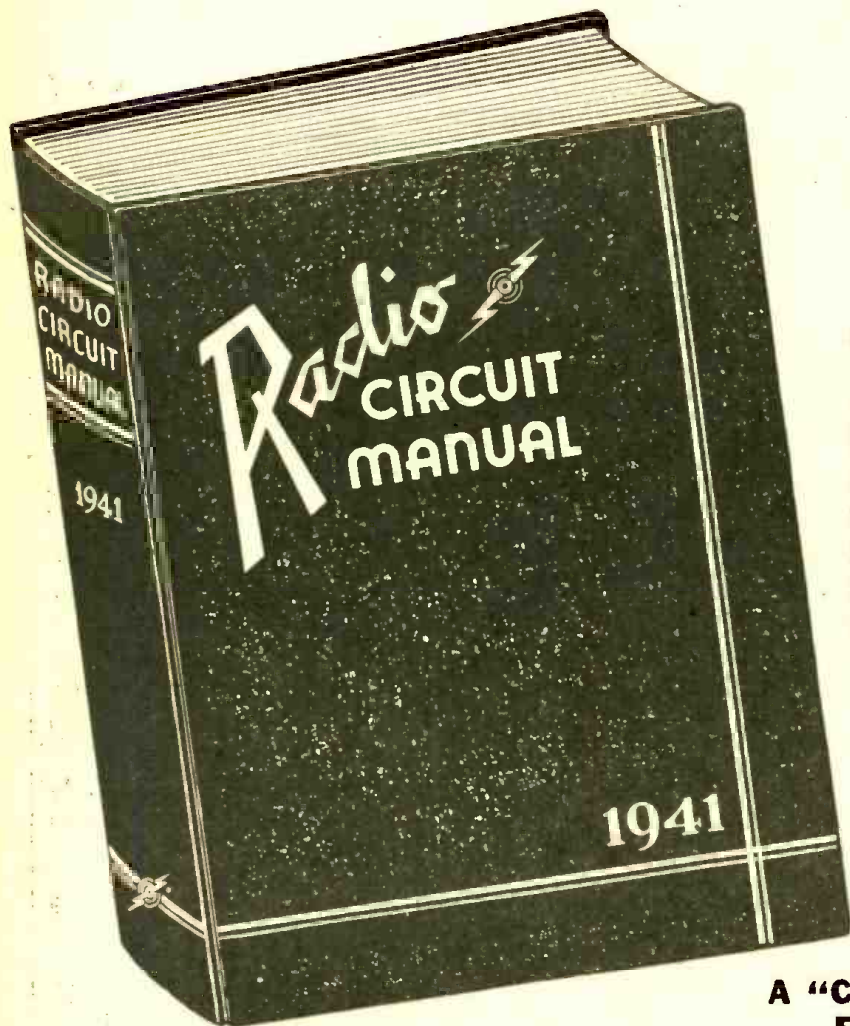

← THE OLD TYPE MANUALS—Bulky, heavy, hard to handle, space consuming, less USEFUL data despite greater number of pages.



→ OUR NEW MANUAL—Lighter, compact, easy to handle, takes half as much room on the shelf, more USEFUL information despite fewer number of pages.

### MANUALS NOW READY!

RADCRAFT PUBLICATIONS, INC.,  
25 West Broadway, New York, N. Y.

Gentlemen: Enclosed find my remittance of \$10.00, for which send me, POSTPAID, my copy of the RADIO CIRCUIT MANUAL—1941.

Name .....

Address .....

City ..... State .....

RC-7-42

(Send remittance in form of check or money order; register your letter if you send cash.)

### ORDER YOUR MANUAL IMMEDIATELY—NOW!

Get your copy directly from us by filling out and mailing the convenient coupon shown at left, or get it directly from your favorite distributor.

736 pages; size 13 5/8 x 10 1/4 x 2 in. thick; loose leaf, leatheroid-covered stiff binder; net weight 6 1/2 lbs.

## A 2-4 TUBE PROGRESSIVE RECEIVER

(Continued from page 686)

mf. section of the filter condenser is now used to bypass the 2,000-ohm cathode resistor of the 12J5GT amplifier tube. No bypass condenser is used on the cathode resistor of the 50L6GT tube. Instead, we introduce a simple means of obtaining inverse feedback in this stage. The .01 mf. condenser connected between plate and cathode in the 50L6GT circuit feeds back a small amount of out-of-phase voltage from the output to the input. Inverse feedback reduces hum and distortion and increases quality and frequency response.

A small magnetic speaker having about 1000 ohms resistance may be connected directly to the output terminals. Although a little more expensive, a P.M. speaker and matching transformer may be used instead of a magnetic speaker for better quality. Headphones may be connected directly to the output terminals if you prefer. They should have an impedance anywhere from 1000 to 3000 ohms.

The procedure in tuning this set is exactly the same as that described for the two tube set of last month. The extra volume control on this four tube set does give an added tuning advantage. Without the volume control, the volume of the set would be reduced by backing down the regeneration control. This would also decrease the selectivity (ability to separate stations). With the volume control, however, the regeneration control may be kept turned up to the optimum operating position and any reduction in volume would be obtained by means of the volume control. This method keeps up the selectivity of the set.

### NOVEL PILOT LIGHT CIRCUIT

In closing, we would like to mention the novel pilot light circuit. The 45Z5GT rectifier has a tapped filament, especially designed for use with a pilot light. If a No. 40 bulb is used, its brilliance will be normal at normal operating voltages for the tubes. As the tubes warm up, the pilot lamp increases gradually in brilliance, instead of flaring up suddenly and then reducing in brilliance as in the older circuits. This method increases the life of pilot bulbs. There is an additional advantage in that if the pilot lamp should burn out, your set will continue to operate just the same.

The list of parts that follows contains only the additional parts required to add the two tube amplifier. This list plus the list published last month, but less the 400 ohm 10 watt resistor, contains all of the parts needed to build the complete four-tube set.

### PARTS LIST

- Three .01 mf. tubular condensers
- Two 100,000 ohm ½ watt resistors
- One 150 ohm ½ watt resistor
- One 2,000 ohm ½ watt resistor
- One 25 henry 200 ohm 60 ma. filter choke
- One 100,000 volume control with switch
- One 12J5GT tube
- One 50L6GT tube
- Two octal sockets
- One magnetic speaker, 1000 ohm resistance

\*Engineer Allied Radio Corporation, Chicago, Illinois.

### POWER INCREASE DENIED

The F.C.C. denied last month the applications of radio stations WJZ, New York, N. Y., and WGY, Schenectady, N. Y., to increase their power to 500 kw.

# SUPER SPECIALS

All of the attractive items listed here are brand new. ALL are in PERFECT WORKING ORDER. In many cases, the parts alone total more than the price we are asking. 100% satisfaction guaranteed or your money refunded. ORDER FROM THIS PAGE. Use the convenient coupon below. Include sufficient extra remittance for parcel post charges, else order shipped express, collect. Any excess will be refunded. C.O.D. shipments require 20% deposit. If full remittance accompanies order, deduct 2% discount. Send money order, certified check, new U. S. stamps. No C.O.D. to foreign countries.

ORDER TODAY LIMITED QUANTITIES PROMPT SHIPMENTS ASSURED

### HANDY WORKSHOP OUTFIT



Here is a marvelous article that to the best of our knowledge has never sold at such a low price. This outfit must be seen to be appreciated. It delivers the goods! It comprises a variable speed universal motor for 110 volts A.C. or D.C. Made originally for dictaphone machines by American Gramophone Co. Motor is reconditioned and in excellent condition; all other parts are brand new. Special lever control permits various speeds up to 3000 r.p.m. Measures 7 1/2" x 3 1/4" diam. overall.

Included in the outfit are the following items, as illustrated: 1 excellent chuck which takes drills and other tools—chuck is easily screwed to motor shaft; standard safety wheel, 4" diameter; fine steel rotary saw, 4" diameter; wire scratch brush, 4" diameter; standard cloth buffer, 3" diameter. Total Wt. 0 lbs.

ITEM NO. 149 Complete outfit, including motor. YOUR PRICE ..... \$5.45

### WESTON MODEL 562 A.C.-D.C. AMMETER



Designed by Weston for the Eastman Kodak Co. It is a precision-built magnetic-vane type ammeter which, with suitable shunt, can be used as a milliammeter too. It is 2 1/2" in diameter and designed for panel mounting. Bakelite base and black-enamelled cover. Shp. Wt. 2 lbs.

ITEM NO. 35 YOUR PRICE ..... \$1.25

### POWERFUL ALL-PURPOSE INDUCTION MOTOR IDEAL FOR EXPERIMENTERS—101 USES

Sturdily constructed to precision standards, this self-starting shaded pole A.C. induction motor is powerful enough for a large variety of uses. Some of these are: Automatic Timing Devices, Current Interrupters, Electric Fans, Electric Chimes, Window Displays, Photocell Control Devices, Electric Vibrators, Small Grinders, Buffers and Polishers, Miniature Pumps, Mechanical Aids, Sewing Machines, Phonograph Motors, Coffee Grinders, Motion Picture Projectors, Motorized Valves, Sirens, and other applications.

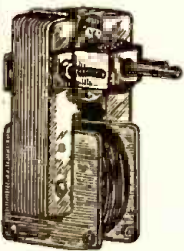

Consumes about 15 watts of power and has a speed of 3,000 r.p.m. When geared down, this sturdy unit will constantly operate an 18-inch turntable loaded with 200 lbs. dead weight—THAT'S POWER!

The motor is of midsize dimensions, 3 inches high by 2 inches wide by 1 1/2 inches deep; has 4 convenient mounting studs; shaft is 7/8" long by 3/16" diameter, and runs in self-aligning, oil-retaining bearings; the best materials, perfect precision assembly and rigid inspection certify to its high quality, and assure long life. Designed for 110-20 volts, 60-60 cycles, A.C. only.

ITEM NO. 147 YOUR PRICE ..... \$1.29

### 100 POWER TELESCOPE LENS KIT



Make your own high powered 6 ft. telescope! Now you can thrill to a close-up view of the worlds out in space. See the rings around Saturn, the mountains of the moon! Kit contains 3" diam., 75" focal length, ground and polished objective lens and 2 astronomical eye-pieces, magnification 60x and 100x.

Complete kit with full instructions. ITEM NO. 123 YOUR PRICE ..... \$1.95

NEW—EXTRA LARGE LENS KIT—contains completely finished 4" diameter 100" focal length ground and polished objective lens, three 1 1/2" diameter eye-pieces giving 86x, 133x, and 200x, an aluminumized diagonal for overhead viewing, and a color filter for insertion in any eyepiece.

ITEM NO. 123L YOUR PRICE ..... \$3.95

## HUDSON SPECIALTIES CO., 40 West Broadway, N. Y. C.

IT'S EASY TO ORDER—CLIP COUPON—MAIL NOW ORDER FROM THIS PAGE.

HUDSON SPECIALTIES CO., 40 West Broadway, Dept. RC-7/42, New York, N. Y. I have circled below the numbers of the items I'm ordering. My full remittance of \$..... (include shipping charges) is enclosed.

OR my deposit of \$..... is enclosed (20% required), ship order C.O.D. for balance. No C.O.D. order for less than \$2.00. (Now U. S. stamps, check or money order accepted.)

Circle Item No. wanted: 11, 33, 35, 87, 123, 123L, 147, 149, 151, 152, 153

Name ..... Address .....

City ..... State .....

Send remittance by check, stamps or money order; register letter if you send cash or stamps.

### WESTERN ELECTRIC BREAST MIKE

This is a fine light-weight aircraft carbon microphone. It weighs only 1 lb. Mike comes with breast-plate mounting and has 2-way swiveling adjustment so that it can be adjusted to any desired position. There are 2 woven straps; one goes around neck, the other around chest. Straps can be snapped on and off quickly by an ingenious arrangement.

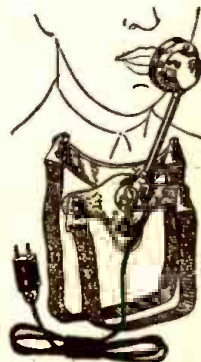

This excellent mike can be adapted for home broadcasting or private communication systems. By dimming the microphone, it can be used as desk mike. Comes complete with 6-foot cord and hard rubber plate finished in spherulized plate, non-rustable.

THIS IS A BRAND NEW MIKE. IT HAS NEVER BEEN SOLD AT SUCH A LOW PRICE BEFORE. ORIGINAL LIST PRICE \$15.00. Shipping weight, 2 lbs. ITEM NO. 152 YOUR PRICE ..... \$1.00

### METAL CUTTING SAW



Here is an ideal metal-cutting saw made of fine tool steel specially designed to cut metal. Teeth are set at a special double angle for metal-cutting work. Saw is specially hardened for long and extended use; measures 3 1/4" diameter; center hole is 1/2" square; thickness 42/1000 (42 mils.) 3/64".

ITEM NO. 151 YOUR PRICE ..... 50c

### POWER ADJUSTABLE RHEOSTAT

Here is an excellent rheostat used especially to regulate speeds of small motors, such as our Handy Workshop Outfit. This rheostat can be used in connection with motors up to 1/20 h.p.



This fine rheostat is wire-wound on porcelain insulation. The black enamel steel casing is perforated for ventilation. Adjustable handle regulates speed of motor easily and smoothly. Size 5"x2 3/4" overall. Shp. Wt. 2 lbs.

ITEM NO. 153 YOUR PRICE ..... \$1.20

### AMAZING BLACK LIGHT!!

Powerful 250-Watt Ultra-Violet Source



The best and most practical source of ultra-violet light for general experimental and entertainment use. Makes all fluorescent substances brilliantly luminescent. No transformers of any kind needed. Fits any standard lamp socket. Made with special filter glass permitting only ultra-violet rays to come through. Brings out beautiful opalescent hues in various types of materials. Swell for amateur parties, plays, etc. to obtain unique lighting effects. Bulb only. Shp. Wt. 1 lb.

ITEM NO. 87 YOUR PRICE ..... \$2.00

### WATT HOUR METER

Completely overhauled and ready for immediate service. Designed for regular 110-volt 60 cycle 2-wire A.C. circuit. Servicemen use it in their shops to check current consumption of motors, soldering irons, etc. Keeps coats down. If dismantled, the parts alone would bring the price. The elaborate gear train could be used as a counter on machines of various kinds. Simple to install: 2 wires from the line and 2 wires to the load. Sturdily constructed in heavy metal case. Size: 8 1/2" high, 6 1/2" wide, 5" deep. Westinghouse or General Electric. Shp. Wt. 14 lbs.

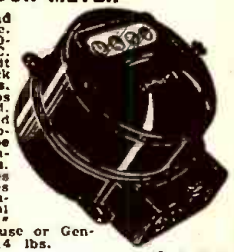

ITEM NO. 33 YOUR PRICE ..... \$4.50

**READ LIKE AN EXPERT**  
**SEND CODE**

Learn Quickly at Home—Get Real Speed

It's easy, fascinating, to become a good op. with the NEW ALL-ELECTRIC MASTER TELEPLEX CODE TEACHER to help you. Only instrument ever produced which records your sending in visible dots and dashes—then sends back to you at any speed you desire. That is why so many schools teaching code prefer Master Teleplex, why thousands agree this method is surest and quickest—has taught more ops in the past few years than all other methods. There are NO PERFORATIONS—NO INK. Far superior to anything ever developed... a marvel of simplicity.



**FREE BOOK**  
We furnish Complete Course. I send you Master Teleplex, give you personal instruction with a MONEY-BACK GUARANTEE. Low cost. Send today for booklet \$5. No obligation.

**TELEPLEX CO.,** 107 HUDSON ST., JERSEY CITY, N. J.

**Amazing New "WALSCO" STAPLE DRIVER**

for radio men, electricians, or anyone doing stapling. Makes wire and cable installations twice as easy—much neater—saves half the time. Wires can be stapled in corners, behind pipes, into moldings—places never accessible with a hammer and ordinary staples. Drives staples even into walls, brick, mortar, etc. Magazine works automatically and holds strips of staples which come in several colors. Ask your jobber for demonstration and catalogue 41-C of all WALSCO PRODUCTS or write **WALTER L. SCHOTT CO.** 5264 W. Pico Boulevard, Los Angeles, California

**Do you need BINDING POSTS?**

The XL PUSH POST with its Spring Action assures Constant Contact and quick connection. Manufactured in All Aluminum Type #1 at 22c each. Aluminum Body, Bakelite Top Type #1 at 15c each. Types CP or NP. ALL BRASS—STAINLESS STEEL—SPRING & PIN PROVEN BY 240 HR. SALT SPRAY TEST as NON-CORROSIVE at 28c each. Manufacturers and Dealers Liberal Discounts

**X. L. RADIO LABORATORIES**  
420 West Chicago Ave., Chicago, Ill.

**New Handy UNIVERSAL REPLACEMENT Capacitors**

Write for Catalog

**SOLAR MFG. CORP., Bayonne, N. J.**

**HIGH EFFICIENCY results in Sound National Defense**

that is why **NATIONAL DEFENSE SOUND SYSTEMS** are equipped with **University Reflex HIGH POWER LOUDSPEAKERS**

**UNIVERSITY LABS.** 195 CHRYSTIE ST. N.Y.C.

**OPPORTUNITY AD-LETS**

Advertisements in this section cost 15 cents a word for each insertion. Name, address and initials must be included at the above rate. Cash should accompany all classified advertisements unless placed by an accredited advertising agency. No advertisement for less than ten words accepted. Ten percent discount six issues, twenty percent for twelve issues. Objectionable or misleading advertisements not accepted. Advertisements for August, 1942, issue must reach us not later than July 10, 1942.

Radio-Craft • 25 W. B'way • New York, N. Y.

ONE, TWO AND THREE-TUBE SET PLANS: "TELIO", "Tollotron", "Tollo-Bulldor", "Radio-Bulldor", "Radio-Tello"—All 25c. Tolloradio, 524 Fairbanks Avenue, Oakland, California.

SPOT CASH UP TO \$5.00 FOR NEW RADIO INVENTIONS. Tollotron, 524 Fairbanks Avenue, Oakland, California.

USED CONFORMANCE COURSES AND TECHNICAL BOOKS BOUGHT, SOLD, RENTED, CATALOG FREE. Educational Exchange, Henagar, Ala.

WANTED: SET RIDER'S MANUALS. P.O. BOX 963, San Bernardino, Calif.

**RADIO PATENTS REVIEW AND DIGEST**

**Television**

No. 2,274,039 issued to A. J. Cawley, Pittston, Pa.

The inventor claims improved methods of transmitting visual images of objects or pictures from one point to another point by means of wire or wireless. Some of the objects of the invention are as follows:

The provision of a plurality of concentric cylinders in contradistinction to disks for producing the image. One of the cylinders may be a mask to obscure the undesirable intersecting points of the light permeable areas carried on the other two cylinders. Or the third cylinder may carry means for concentrating the light along the path of the intersections produced by the light permeable areas of the other two cylinders.

Improved means are provided for rotating two or more cylinders in opposite directions and for framing the picture, particularly with the object of taking advantage of superposed projection of images. Also, a method of framing wherein stereoscopic pictures are produced which may also be colored, one modification using two wave sources, another using one wave train with a plurality of circuits containing the photoelectric elements, and another modification utilizing a single wave train and a single lamp which possesses unilateral conducting properties in such manner that one component of the alternating current produces one picture series and the other component produces an entirely distinct series of pictures. A method of scanning is also disclosed which obscures the superfluous light dots and eliminates the rotating mask.

A projection process is disclosed which employs two or more projecting means placed at different angles to the screen, while the screen is provided with a series of ridges whereby the light from each projector is projected upon a certain series of surfaces of the ridges. That is, the right hand projecting means projects the pictures on the right hand surfaces, while the left hand projector projects the light on the left hand surfaces. This gives three dimensional effects to the screen.

A method of scanning which employs a single endless band carrying light permeable areas, this band travelling over two drums is also disclosed.

Figure 1 illustrates a very simple scanning medium, consisting of a single endless belt travelling over two drums.

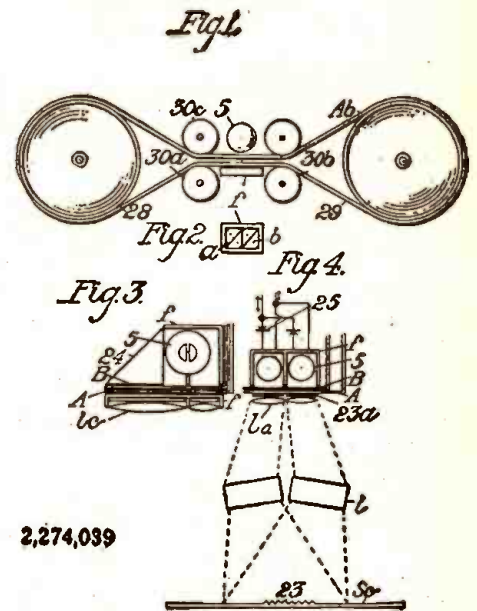

Fig. 2 is a front view of the frame of Fig. 1. Figure 3 shows a method of producing two distinct pictures which may be stereoscopic and colored, each of the component pictures being produced by one of the components of the alternating current. This is accomplished by the use of a single lamp possessing unilateral properties. This figure also discloses a prismatic reflector to throw all of the light of the lamp forward.

Fig. 4 shows a method of producing stereoscopic, colored pictures which utilizes the two components of the alternating current to build up two distinct pictures.

This application is a continuation in part application of U. S. Patent No. 2,032,526. The disclosure in this patent is to be read in conjunction with that of the above mentioned patent.

Various means for exploring the successive elemental areas of image fields, including two oppositely moving media bearing angularly arranged light permeable areas, and means for moving them are illustrated in Patent No. 2,032,526, which is the parent patent.

**Radio Apparatus**

No. 2,274,434 issued to Charles F. Sheaffer, Tulsa, Okla.

This invention relates to frequency stabilizing and adjusting systems and frequency deviation indicators.

One object is to provide a frequency discriminating device, the rectified output of which is a DC voltage, whose polarity and amplitude is directly proportional to the frequency deviation and direction of deviation between an oscillator of fixed frequency and an oscillator the frequency of which is to be controlled, or the deviation from the fixed frequency, which is to be indicated by a metering device.

Another object is to provide a discriminator-detector device, the balance frequency (frequency of zero direct current output) of which is determined solely by the fixed frequency oscillator, and is therefore not subject to variation due to temperature changes or circuit instabilities.

The inventor provides two beat frequency detectors for the purpose of deriving the beat frequency between two oscillators, the frequency of one of which is more or less fixed and the frequency of the other subject to variation, the magnitude of which it is desired to limit and/or indicate by metering device. In addition a phase shifting device is used to shift the phase of one of the oscillators before application to one of the beat detectors, this being for the purpose of displacing the phase of the two beat detector outputs by 90 degrees. A further phase shift is provided to one of the beat detector outputs which gives an additional shift of 90 degrees and renders the shifted beat output a direct function of the frequency. Under the above circumstances a phase turnover of 180 electrical degrees occurs

between the derived beat supplies as the frequency deviation of the varying oscillator shifts from negative values through zero-beat to positive values. Two amplifiers are provided for amplifying the two beat supplies to the proper level and two transformers mix the two beats and apply the resulting voltages to a double diode detector, the purpose of which is to provide a direct current voltage proportional to the fre-

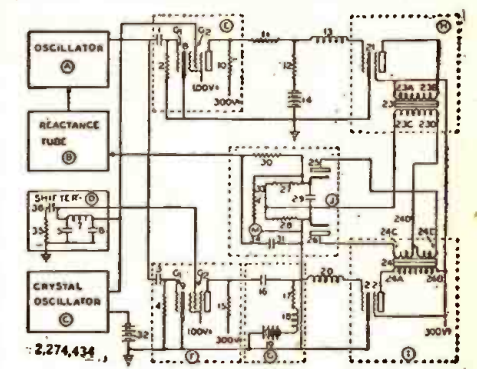

frequency deviation and direction of deviation of the frequency of the oscillator subject to variation from the frequency of the reference oscillator.

Oscillator A is a regenerative vacuum tube oscillator utilizing a tuned circuit as the frequency determining element. The reactance tube B forms a part of the frequency determining circuit of A and thereby permits the frequency of the oscillator A to be controlled by the bias voltage supplied to the grid of the reactance tube device

# RADIO PATENTS REVIEW AND DIGEST

B. This combination is conventional and has been described in various publications.

Oscillator A supplies a radio frequency voltage through condenser 1 to grid G<sub>1</sub> of vacuum tube 8. It also supplies, through condenser 3, grid G<sub>2</sub> of vacuum tube 9. Crystal oscillator C, which is a conventional device, utilizing a vacuum-tube oscillator in which a quartz crystal forms the frequency determining element, supplies a radio frequency voltage to grid G<sub>2</sub> of tube 8. It also supplies the phase shifting network D which shifts the phase of the crystal frequency by exactly 90 electrical degrees and supplies the shifted output to grid G<sub>2</sub> of vacuum tube 9. Vacuum tubes 8 and 9 are mixer-detector devices, the purpose of which is to derive a beat frequency equal to the difference in frequency between oscillators A and C. For the purpose of illustration let it be assumed that the frequency of oscillator C is exactly 1000 kilocycles and that the frequency of oscillator A is near 1000 kilocycles, but is prone to vary above or below this frequency because of the effects of temperature variation and circuit instability. For example assume that the frequency of oscillator A becomes 1001 kilocycles. In this event, a beat frequency of 1000 cycles appears across resistor 10 in the plate circuit of detector E and across resistor 15 in the plate circuit of detector F.

The beats in the plate circuits of tubes 8 and 9 occur as a result of the falling in and out of step of the two radio frequency voltages when the phase of one of them is advancing at a greater rate than the other, which is a result of a frequency difference. The phase displacement afforded by shifter D therefore causes a 90 degrees phase displacement between the two beat-frequency sources at the plates of detectors E and F. If the frequency of oscillator A becomes 999 kilocycles, the phase relation between the beats will be reversed due to the fact that the phase of oscillator A is now continuously retarding with respect to that of oscillator C, whereas, when the frequency of oscillator A was 1001 kilocycles, its phase was continuously advancing with respect to that of oscillator C. The phase reversal indicated occurs at zero-beat, since it is dependent upon whether the phase of oscillator A is advancing, or retarding with respect to that of oscillator C.

The purpose of network G is to provide an additional phase displacement of 90 degrees between the two beat frequency supplies and to provide an output, the amplitude of which, is proportional to the frequency. Network G is therefore interposed between the plate of detector tube 9 and the grid circuit of tube 22. Coil 20 has no appreciable reactance at the beat frequencies, but effectively chokes out radio frequency from the oscillators.

The voltages at the grids of tubes 21 and 22 will as a result of the previously explained phase shifts be either in phase or out of phase depending upon whether the frequency of oscillator A is higher or lower than that of oscillator C.

Vacuum tubes 21 and 22 are provided for amplifying the beat voltages delivered to their grids and applying their respective outputs to transformers 23 and 24, which, in turn, supply the balanced rectifier device J.

The output connection from the balanced rectifier J is made between the cathodes of tubes 25 and 26. With this connection the rectified voltage at the output will be zero if the voltages applied to the plates of tubes 25 and 26 equal. It will also be zero if one of the transformer voltages is zero. If the alternating voltages are unequal, a difference voltage will appear the polarity of which will depend upon which of the voltages is greater.

In considering the performance of the complete device it is apparent that if the frequency of oscillator A is equal to that of oscillator C, the beat outputs of detectors E and F will have zero frequency and since transformers 23 and 24 cannot pass direct current, the output of detector J will be zero. If the frequency of oscillator A deviates, a resulting beat frequency is applied to the balanced rectifier J from separate sources through transformers 23 and 24. The amplitude of the source from transformer 23 does not vary with the beat frequency, but the amplitude of the beat frequency delivered by transformer 24 is directly proportional to the frequency, therefore the voltage output of the detector J will depend upon the extent to which the voltage from the secondary of transformer 24

can unbalance the voltage applied to the two rectifier plates from the secondary of transformer 23. In other words, the unbalance, and hence the balanced detector output is directly proportional to the beat frequency and its polarity is dependent upon the phase relation of the beat sources, which reverses as the frequency difference goes through zero-beat.

The output of rectifier J is a pulsating direct current voltage and its pulsations are filtered out by condensers 29 and 31 in conjunction with resistor 30. The voltage across condenser 31 is therefore a pure direct current voltage whose polarity and amplitude are dependent directly upon the deviation and direction of deviation of the frequency of the oscillator A. This voltage is supplied to the grid of the reactance control tube B which directly and automatically limits the possible frequency deviation of the oscillator A.

Transformers 23 and 24 are high grade iron core devices capable of delivering constant amplitude response throughout a frequency band extending from 15 to 15,000 cycles. The transformers, as well as other components are selected to make the phase shift characteristics of amplifiers H and I identical.

Milliammeter 34 in conjunction with resistor 33 is calibrated to read the amount which the frequency of oscillator A deviates from that of C.

## Antenna System

No. 2,283,897 issued to Andrew Alford, New York, N. Y.

A radio antenna system comprising a peripherally arranged planar radiant acting linear conductor means of small dimensions relative to the operating wavelength arranged along a planar periphery, a transmission line section directly connected to and forming a continuation of said radiant acting conductor means said section being dimensioned to tune said system to the operating frequency to produce substantially uniform current distribution in said radiant acting conductor means, energy transfer means coupled to said transmission line section in energy transfer relation at a point such that if energy were supplied thereat current would circulate about said periphery in the same sense at all points, whereby radiant action of said system is substantially uniform in all directions about said periphery and has everywhere a polarization substantially parallel to said plane.

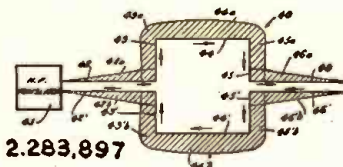

2,283,897

## Antenna

No. 2,283,914 issued to Philip S. Carter, Port Jefferson, N. Y.

An antenna system operative over a wide range of frequencies comprising an aerial conductor having a pair of separated arms arranged end to end and providing terminals at the adjacent ends of said arms, another aerial conductor arranged parallel to said first conductor and spaced very close thereto relative to the length of the operating wave, connections between the ends of said last conductor and points on said arms removed from the adjacent ends of said arms, whereby the impedance of said antenna system at said terminals is increased over that of a single conductor dipole, and a two-wire open feeder line having a predetermined impedance directly connected to said terminals, the impedance of said antenna at said terminals being of the order of the impedance of said two-wire open feeder line whereby said antenna system has an extremely flat impedance versus frequency characteristic over said range of frequencies.



2,283,914

## Art of Radiometeorography

No. 2,283,919 issued to Harry Diamond, Washington, D. C., and Wilbur S. Hinman, Jr., Falls Church, Va.

Means for transmitting meteorological information and like factors, as from an unmanned balloon, comprising means for transmitting a carrier wave, means for applying to said carrier wave modulations characteristic of the respective factors to the transmitted, means for varying the modulations applied thereby in accordance with variations in said respective factors, and barometric pressure responsive means for affecting said applications serially in response to definite incremental changes in barometric pressure.

## Magnetically Tuned High Frequency Circuits

No. 2,283,924 issued to Robert L. Harvey, Oaklyn, N. J.

A pair of resonant coupled circuits for an intermediate frequency amplifier of a super-heterodyne receiving system, comprising a pair of fixed inductors, having turns disposed in extended relation, a relatively adjustable core of magnetically permeable material for each inductor, said inductors being loosely coupled and relatively so disposed that certain respective turns are adjacent and other turns are remotely positioned, said cores being disposed for operation in the field of said remotely positioned turns for varying the self inductance of said inductors without substantially changing the coefficient of coupling.

(See also Patent Nos. 2,283,925 and 2,283,926 by the same inventor.)

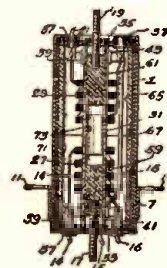

2,283,924

## Transmission, Radiation, and Reception of Electromagnetic Waves

No. 2,283,935 issued to Archie P. King, Red Bank, N. J.

In a system for the directive radiation or reception of high frequency electromagnetic waves, the method which comprises separately and concurrently guiding adjacent portions of the wave front of said electromagnetic waves, systematically altering relative to each other the velocities of propagation of the respective wave portions as so guided, whereby the shape of said wave front is modified, and then projecting all of said guided wave portions into coalescing relation to form a unitary wave.

## Commutator Oscillograph Device

No. 2,283,951 issued to Kenneth C. Ripley, Washington, D. C.

Means for simultaneously indicating a plurality of direct-current voltages on the viewing screen of a cathode-ray oscillograph, comprising a first commutator having a plurality of live segments each of which is connected to a source of one of said voltages, and a plurality of neutral segments, one of which is located between each pair of said live segments, a second commutator having a plurality of segments, the number of which is a whole number of times the number of those in said first commutator, a resistor, the segments of said second commutator being connected in order at spaced points along said resistor, a pair of brushes, each arranged to sweep the segments of one of said commutators, means connecting said brushes in such a manner that they must move in unison, means connecting the brush of said first commutator and the sources of voltages

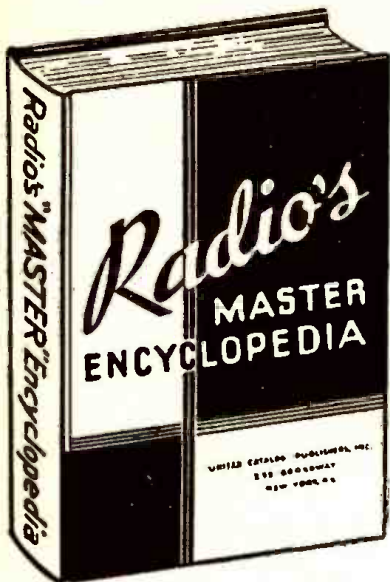

**9th EDITION  
OVER 800 PAGES**

**THE ONLY OFFICIAL  
RADIO PARTS AND  
EQUIPMENT MANUAL**

It took six years and thousands of dollars to develop this "MASTER CATALOG" of the radio industry to its present size—yet it costs you only \$3.50.

Compiled in co-operation with and approved by the Radio Manufacturers Group as the industry's official source book.

**GIVES THIS IMPORTANT  
DATA**

Contained within the hard covers of this 800 page MASTER BOOK are the listings of the products of 90% of all Radio Parts and Equipment Manufacturers in the industry. In it you will find many thousands of items, such as electronic devices, transmitting and receiving sets, tubes, antennas, transformers, condensers, replacement parts, meters, laboratory test equipment, relays, plugs, coils, wire, and numerous other radio components. Thousands of clear illustrations with descriptions and specifications.—Yes, this is your "MUST HAVE BOOK."

**WHO USES IT?**

As the official source book of the radio industry it is constantly used by many American and foreign governmental agencies, also industrial organizations, engineers, purchasing agents, laboratories, radio amateurs and service men, radio distributors, broadcast stations, schools, colleges, libraries, and by many others interested in Radio and allied fields.

**SAVES TIME—SAVES MONEY**

**WHERE, WHAT AND HOW MUCH:** Such information is instantly at your fingertips. This Valuable RADIO MASTER eliminates the maintenance of bulky files. It is completely indexed for speedy reference.

If you buy, sell or specify you will find the RADIO MASTER an indispensable and handy book to have around at all times.

**MONEY BACK GUARANTEE!**

Order your copy today—look it over. You will find it to be an excellent investment; if not, return it to us in five days for full refund.

The price is only \$3.50 shipped anywhere in U.S.A.—\$4.00 elsewhere. We prepay transportation charges if remittance accompanies order. (Prompt delivery guaranteed!)

**N. GRAY (DISTRIBUTOR)**  
160-22 97th Street  
Howard Beach L. I. New York

**RADIO PATENTS REVIEW AND  
DIGEST**

(Continued from previous page)

to be indicated across the vertical deflection plates of said oscillograph, and means connecting the brush of said second commutator and a terminal of said resistor across the horizontal deflection plates of said oscillograph.

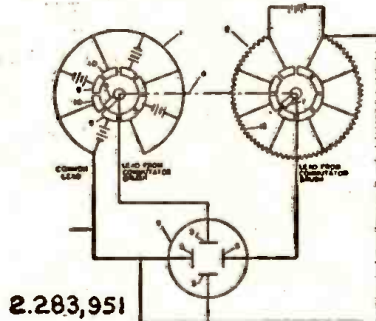

2.283,951

**Telephoto Machine**

No. 2,284,027 issued to Louis A. Thompson, Lakewood, Ohio.

An apparatus for facsimile transmission including a light source, means to convert said light from said source to a beam, means for swinging said light beam including an oscilloscope, a mask over which said swinging beam passes formed to provide an opening therein, said beam adapted to pass through said opening during part of its swing, a picture movably disposed in the path of said beam beyond said mask, and means for picking up and converting said light into electrical currents after having engaged said picture.

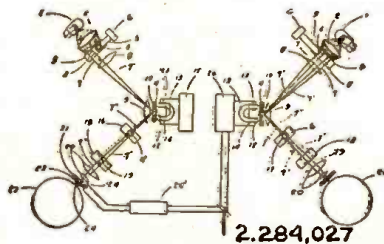

2.284,027

**Audible Meter**

No. 2,284,008 issued to Isadore Miller, Trenton, N. J.

In apparatus of the character described, a circular base portion, an arm rotatably mounted at the center of said base portion, a sound pick-up unit carried by said arm, an arcuately extending sound track mounted near the edge of said base portion but extending less than the total distance around said base portion to thereby provide a cut-out portion at one position along the edge of said base portion, a plurality of sound track segments each of which is of proper size to be inserted in said cut-out portion and to be positioned in alignment with said arcuately extending sound track, means rotatably mounting said sound track segments so that they may be successively moved into said cut-out portion, and means to rotate said arm and move said sound pick-up device along said arcuately extending sound track and the particular sound track segment which is in alignment therewith.

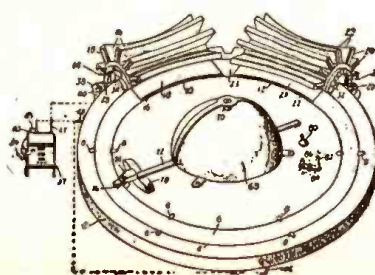

2.284,008

**Amplifier**

No. 2,284,064 issued to Adolph R. Morgan, Merchantville, N. J.

The combination of end and intermediate power supply terminals, a pair of direct current circuits including reversely arranged impedance sections connected in parallel between said end terminals, means for similarly varying the current through one pair of the opposite end sections of said circuits, and means connected between said intermediate terminal and the other opposite end sections of said circuits for deriving voltages displaced in phase from one another.

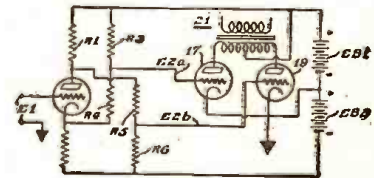

2.284,064

**Inverse Feedback Amplifier  
System**

No. 2,284,083 issued to Donald S. Bond, Philadelphia, Pa.

An audio frequency amplifier comprising, in combination, a balanced power output stage including an input transformer and an output transformer provided with a center tap, a driver stage coupled to said first-named stage, an output circuit for said driver stage including the primary of said input transformer and a connection on the primary of said output transformer in spaced relation to the center tap thereon, whereby at least a portion of said output transformer primary is included in said driver stage output circuit for establishing a predetermined degree of inverse feedback in said amplifier, and means included in shunt with another portion of said output transformer primary on the opposite side of said center tap for balancing the load on the output transformer.

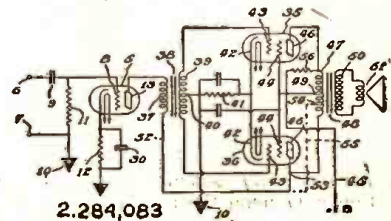

2.284,083

**THE ATTIC INVENTOR'S  
CONTRIBUTIONS TO SCIENCE**

(Continued from page 679)

panies have patent departments with huge appropriations for patent development, prosecution, and protection against infringers. It would perhaps be expecting too much of the government to ask it to provide laboratory or other aids for inventions in the incubation period—although it does give such aids to wild game. But it would seem a very wise policy for it to forego at least the exaction of the thirty dollars filing and thirty dollars issue fees, required by the patent office. At a normal rate of say 1,000 patents a week this would cost the government in patent office fees only three million dollars annually. It might even reduce the amounts of patent attorney fees by telling an applicant what he is entitled to as well as merely what, in their opinion, he is not entitled to. After all, eternity minus seventeen years is still a very long time. Such encouragement would cut away a considerable portion of the handicap facing independent inventors, and it would be a cheap enough price to pay for the expansion of inventive effort that is sure to follow.

Let us encourage the independent inventor in every possible way so that posterity as well as the inventor may benefit.

## HOME-MADE TRANSCEIVERS MAY AID IN AIR RAIDS

AMATEURS TO GET SPECIAL PERMITS  
FOR 25-WATT LOCAL USE

Two-way radio communication in air-raid emergencies, employing the skill of civilian technicians, including radio amateurs, was envisaged last month in a joint statement by the Office of Civilian Defense and the Federal Communications Commission, which announced a new WAR EMERGENCY RADIO SERVICE, providing for the use of "Civilian Defense" stations. Under authority granted in Order No. 9 of the Defense Communications Board, the two agencies are collaborating their activities relative to proposed emergency civilian-defense radio systems to be available in the event air raids damage or destroy other means of communication.

Thousands of compact radio stations to be constructed and operated under prescribed restrictions largely by persons who have had amateur radio experience are expected to augment the services of the OCD organizations throughout the nation. According to radio engineers the two-way radio stations can be constructed of the unused "junk" material which amateurs and radio repairmen usually accumulate in their "storerooms." The transmitters will use not more than 25 watts input power, which will limit their effective communicating range to approximately ten miles, the longest distance ordinarily necessary for this type of service.

OCD Director James M. Landis, in a memorandum to the nine OCD regional directors, said:

"Although the War Emergency Radio Service is the outgrowth of a recommendation which the Office of Civilian Defense made to the Defense Communications Board for the reactivation of amateur radio for civilian defense purposes, it must be understood that it is being set up as an entirely new radio facility which may be put in operation only upon the specific authorization from the Federal Communications Commission."

Persons holding commercial radio operator licenses, including radio engineers employed in broadcast stations, qualified repairmen, and others interested, are expected to join the civilian defense communication system. One amateur organization as well as broadcast stations are encouraging their members to participate in building up the new radio system. Printed manuals designed to facilitate administrative operation will be distributed by the OCD through its regional offices.

Officials at the Communications Commission explained that blanket licenses for all civilian-defense radio stations within a civil defense operations area would be granted to an "instrumentality of local government" when the equipment is in the possession or control of the local government. A "radio aide" for the local instrumentality must be certified and appointed in accordance with FCC rules. Separate operator licenses designated "War Emergency Service Operator Permits" will be issued to persons assigned to operate each radio station. However, it was emphasized at the FCC that no individual operator permit of this special class will be issued unless the applicant first holds a regular FCC operator license or permit, and only after the FCC has been satisfied in regard to the integrity and loyalty of each applicant for a War Emergency Service Operator Permit.

James Lawrence Fly, chairman of the

Defense Communications Board and the Federal Communications Commission, declared that:

"This gives thousands of amateurs an opportunity to employ their radio skill in their local protection services.

"The new emergency service may be described as a stand-by facility to be used when other means of communication fail. We have assigned certain bands of frequencies above 112,000 kilocycles for the use of the OCD organizations, and provision has been made for testing during blackouts and other mobilization trials," he said.

Since the United States has been at war, all amateurs have been banned from the air by the FCC, as requested by the Defense Communications Board. Since that time a representative amateur organization of national scope, the American Radio Relay League, has been co-operating with the OCD and the FCC so that radio amateurs will be made available to assist in alleviating the damaging effects of possible air raids on this country. The FCC acted immediately after the Japanese attack on Pearl Harbor last December to "silence" all amateur radio stations in this country, but soon thereafter permitted some of the amateurs to operate when they were needed for "local defense." However, on January 9th the FCC issued an Order stating that because of events subsequent to its Decem-

ber 7th Order and because of military requirements, all amateur radio operation must be suspended.

## FCC SEEKS DATA ON FOREIGN LANGUAGE "TIME BROKERS"

The Federal Communications Commission last month directed its staff to ascertain the activities of "time brokers" in foreign-language broadcasts over domestic radio stations. A letter requesting full information in this respect is to be addressed to licensees using their facilities for broadcast programs in foreign tongues.

Approximately 210 standard broadcast stations in this country have foreign-language programs, and it is estimated that nearly half of these sell time to "brokers." These "brokers" are not station employees, but rather are independent contractors, apparently independent of any one station for their livelihood. In general, they obtain blocks of time over a given station and arrange their foreign-language programs, selling on their own account spot announcements for use during their allotted time. Many act as their own announcers and seem to enjoy large followings among foreign-born listeners.

The FCC seeks to learn which "brokers" operate over which stations; the precise relationship existing between the "brokers" and their respective stations; the titles of the programs aired, the nature of the programs and whether in the opinion of the licensee there are objections to, or useful functions for, the broker system. Copies of contracts and agreements concerning the operations of the brokers and stations in connection with the foreign-language programs are to be filed with the Commission.



Good receivers, with priorities and all, are getting extinct as the DODO bird. Don't be caught short. Let me send you an Echophone now!

W9GFQ offers: Big trade-ins, low cost, large stock of parts, supplies, receivers to choose from, prompt shipping service. Dollar for dollar, W9GFQ offers you more.

### BIG 1942 CATALOG

Shows one of largest stock of parts and supplies in country on hand—everything illustrated. Everything in radio for the Ham and Service man.

Buy the best "ham" insurance in the World—U.S. War Bonds and Stamps

**EC-1** Here is the biggest buy in communications receivers. Three bands, tunes from 550 kc. to 30 mc. Electrical bandspread on all bands. Six tubes. Self-contained speaker. AC/DC.

**\$24.50**

**EC-2** Eight tubes, three bands, tunes from 550 kc. to 30 mc. 5" PM dynamic speaker, preselection, calibrated bandspread, automatic noise limiter. AC/DC. All these features for only **\$42.50**

**EC-3** Ten tubes. Crystal filter (four positions). Calibrated bandspread, automatic noise limiter, 2 stage IF amplifier, fly-wheel tuning, separate 6" PM dynamic speaker, three bands—550 kc. to 30 mc. All these features are usually found in receivers selling at double this price **\$59.50**

## WHOLESALE RADIO LABORATORIES

746 W. BROADWAY

COUNCIL BLUFFS, IOWA

**NEW CATALOG**  
**OF SOUND AMPLIFYING SYSTEMS**  
 AUDIOGRAPH Sound Systems represent the latest in Public Address equipment—a complete line plus pre-tested accessories.  
**NEW LOWER PRICES**  
 Outstanding quality and performance at prices that help you meet any competition.  
 WRITE FOR YOUR FREE COPY  
**AUDIOGRAPH**  
 THE FIRST NAME IN SOUND  
 John Mack Industries—Liberty 68 Pennsylvania Ave., Plymouth, Ind.

**RADIO ENGINEERING**  
 DEGREE IN 2 1/2 YEARS  
 • Complete Radio Engineering Course in 27 months. Bachelor of Science Degree. Radio (television, talking pictures and the vast electronic field) offers unusual opportunities. Defense needs call for the engineer. Demand exceeds the supply. Courses also in Civil, Electrical, Mechanical, Chemical, Aeronautical Engineering; Business Administration, Accounting, Secretarial Science. Tuition, living costs low. World famous for technical 2 1/2 year courses. Special preparatory department for those who lack required high school work. Enter September, January, March, June. 59th Year. Write for catalog.  
 2472 COLLEGE AVE. ANGOLA, IND.

**TRI-STATE COLLEGE**

**RADIO TECHNOLOGY**

RCA Institutes offer an intensive course of high standard embracing all phases of Radio and Television. Practical training with modern equipment at New York and Chicago schools. Also specialized courses in Aviation Communications, Radio Servicing and Commercial Operations. For Free Catalog write Dept. RC-42.  
**RCA INSTITUTES, Inc.**  
 A Radio Corporation of America Service  
 75 VARICK STREET NEW YORK

**COMMERCIAL RADIO INSTITUTE**

A radio training center for over twenty years. Well equipped. Excellent faculty. Practical resident courses in Defense, Radio Telegraphy, Broadcast, Servicing, Industrial Television, Aeronautical, Drafting, Mathematics and Studio Technique. Placement bureau. Classes now forming for August 3. Catalog upon request.  
 Dept. D, 38 West Biddle Street, Baltimore, Md.

**LES** Correspondence Courses in  
**RADIO and ELECTRICAL ENGINEERING**  
**ELECTRICAL ENGINEERING** Get good grasp technical field. Prepare yourself, at Low Cost, for secure future. Modern, simplified, you can understand quickly.  
**RADIO ENGINEERING** Extra fine course in radio, public address, etc. Write for free catalog to radio, public address, etc. Write for free catalog to radio, public address, etc.  
**FREE** Get copies of school catalog, student magazines, complete details. SEND NOW!  
 LINCOLN ENGINEERING SCHOOL Box 931-243, LINCOLN, NEBR.

**MAKE OLD RADIOS NEW**

You can learn quickly to modernize all sets. No more new radios. Cash-in by improving audio circuits, modernizing cabinets, adding features usually found on late model sets. Practical job-sheets with schematics and photographs make the work easy. Complete. 8 1/2 x 11 inches, manual only \$1.00, post-paid. Money back guaranteed.  
**SUPREME PUBLICATIONS**  
 3727 W. 13th Street, Chicago, Ill.

**RADIO ENGINEERING,**

broadcasting, aviation and police radio, servicing, marine radio telegraphy and telephony, Morse telegraphy and railway accounting taught thoroughly. 48 weeks' Engineering course equivalent to 3 years of college radio work. All expenses low. Catalog free. School established 1874.  
 The Dodge Institute, Monroe St., Valparaiso, Ind.

**Television In Color and Stereoscopic Relief**

An Account of J. L. Baird's Latest Achievement

To obtain the complete illusion of reality in transmission of images to a distance, the received image should have both color and also depth—that is, stereoscopic relief.

In 1926, when television was demonstrated for the first time, the little pictures shown by Mr. J. L. Baird were small and imperfect, and it might be thought that at that early date no effort would have been made to complicate matters by attempts to add color or stereoscopic relief. Such experiments were, however, actually made by Mr. Baird as far back as 1928, when he showed television in color to the British Association. A little later he followed this by an experimental demonstration of monochrome television in stereoscopic relief.

**EARLY PRINCIPLES AS BASIS FOR PRESENT-DAY RESULTS**

It might be interesting to review briefly the principles employed in these first demonstrations, as they form the basis of present-day results. The monochrome television image was transmitted by scanning the image in a success of lines. At the receiver, a screen was scanned by a light spot, which

viewed through glasses fitted with red and blue filters as in anaglyph process. This, while simple, had the disadvantage that it was necessary to wear glasses and that, as the color phenomenon was used to effect the change-over from the right to the left eye, neither the colors nor the stereoscopy could be properly rendered.

**EXISTING-CHANNEL LIMITATIONS ABANDONED**

So far the object in mind had been to produce a system capable of being transmitted through the existing channels available to the B.B.C., but in an endeavor to produce as perfect a result as possible, it was decided to produce an entirely experimental apparatus regardless of existing practical limitations due to war conditions.

In the apparatus demonstrated the frame frequency has been increased from 50/sec. to 150/sec., the scanning altered to a field of 100 lines interlaced five times to give a 500-line picture, successive 100-line frames being colored green, red and blue. At the transmitter, a cathode-ray tube is used in conjunction with photo-electric cells, the

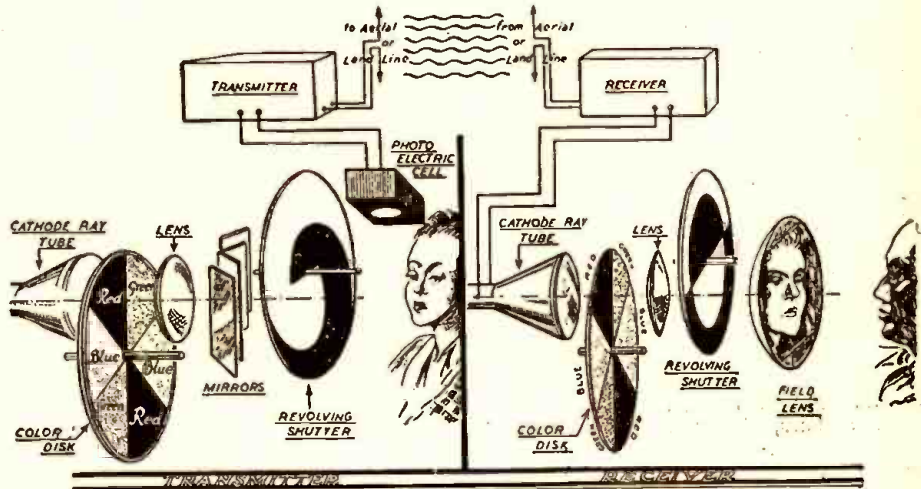

varied its brilliance, depending upon the light and shadow of the picture. In the color process three such pictures were transmitted, one red, one blue, and one green, the three blending to give an image in color. Stereoscopy was obtained by transmitting two images corresponding to a stereoscopic pair and viewing them at the receiving station through a stereoscope.

**12-FOOT COLOR PICTURES DEMONSTRATED**

Little was done to develop either color or stereoscopy for many years. In 1936, however, Baird showed a 12-ft. color picture to a motion-picture audience at the Dominion Theatre, the picture being transmitted from the Crystal Palace by wireless.

This was followed in 1939 by a demonstration of color, using a cathode-ray tube in conjunction with a revolving disc—the method used today. Nothing whatever was done with stereoscopy until recently. Mr. Baird set out to produce a high-definition stereoscopic image in color.

The first experiment was applied to his 600-line two-color apparatus. The red image was made to view the scene from a slightly different angle from the blue, so that the red and blue images constituted a stereoscopic pair, the receiving screen being

moving light spot being projected upon the scene transmitted.

In front of the projecting lens, a mirror angle splits the emerging light beam into two paths separated by a space equal to the separation of the eye. By means of a revolving shutter, the scene is scanned by each beam alternately, so that images corresponding to the right and left eye are transmitted in rapid sequence.

**SUPERIMPOSED COLORS GIVE NATURAL EFFECT**

Before passing through the shutter disc, the light passes through a rotating disc with blue, red and green filters. Thus superimposed red, blue and green pictures blending to give a picture with full natural colors are transmitted for left and right eye alternately.

At the receiver the colored stereoscopic pairs if images are reproduced in sequence and projected upon a field lens, alternate halves of the projecting lens being exposed by means of a rotating shutter, the image of the shutter being projected upon the eye of the viewer so that his left and right eyes are presented alternately with the left and right images, the combined effect being a stereoscopic image in full natural colors.  
 —Journal of Television Society, London.



# Book Reviews

**REPAIRMEN WILL GET YOU IF YOU DON'T WATCH OUT**, by Roger William Riis and John Patric. Published by Doubleday Doran, New York, N. Y. Stiff cloth covers, size 5 x 7½ ins., 271 pages. Price \$1.95.

Radio Servicemen will remember—too well, perhaps—the *Reader's Digest* article, "The Radio Repair Man Will Gyp You If You Don't Watch Out," which set the radio service field afire. The radio article was one of a series of "gyp" articles written with the intention of putting the consumer on guard in his dealings with repairmen.

The book, now published under the general title of *Repairmen Will Get You If You Don't Watch Out*, is somewhat tempered not only in its title, but in its text as well. The authors, in their introduction, relate how the idea of the survey of repairmen in the automotive industry was born. They claim that they went to work with open minds on the subject, believing it would make a good story in any case. Mr. Patric kept insisting that the repairmen would turn out to be 95 per cent honest.

It is regrettable that the *Digest* story was handled as an exposé. We refer to the explanatory heading which appeared at the top of the article: "How radio repairmen profit dishonestly from the public's ignorance." If it had said "How *some* radio repairmen, etc.," it would have been more accurate and might have removed some of the sting—so piercing it caused servicemen to cry out in pain—of coupling radio repair work with dishonesty.

It is, of course, also regrettable that some servicemen were found to be dishonest. Readers of *Radio-Craft* will recall Mr. Gernsback's castigation of these dishonest servicemen and his advice that radiomen clean house (Sept. 1941 issue, page 137.)

To this reviewer neither the article nor the book proved that the radio service trade was dishonest. It proved, rather, that certain dishonest persons were engaged in repair work of one kind or another. Since the cheating found in the automobile-repair field was 63 per cent and in the radio-repair field 64 per cent, the closeness of these figures should bear out this belief.

The authors, Roger William Riis and John Patric, agree that similar dishonesty would very likely be found in other trades and professions, and they make no bones about this likelihood in the legal and medical professions. Their regret is that they are unable to devise some simple trick that could be used in a survey of lawyers and doctors.

Since this book gives an expanded version of the *Digest* radio-repair article, we expected to find information on some of the other dishonest devices (referred to in the original article) which were employed by the service-shop operators. We looked in vain for the well known imaginary transformer replacement that miraculously used to enter so many sets, and we can only surmise that these repair shops no longer stock such transformers, which is very encouraging.

We looked expectantly also for the simplest repair item that could have been added to the investigators' bills: Receiver alignment. There would be no parts to show and the "job" could hardly be questioned by the investigators unless they carried the "Rube Goldbergs" they criticize so much. But, although receiver alignment was added to the original list of diagnoses they were charged for, we were unable to find it in any of the detailed accounts of the survey.

It should be emphasized that no radio-repair job was involved in this survey; that the "repair" involved only a tube pulled loose from its socket or a disconnected battery wire. The inference of the authors seems to be that if they were charged excessively for

such simple and obvious "repairs" what would they be charged for a real repair job? Our belief is that even these dishonest repairmen might not have had to invent diagnoses if real repair problems were presented, and that charges would not have been any higher. We do not recall any such deduction made in the book.

The largest part of this book is devoted to automobile repairmen; radio repair is second in importance and is followed by the surveys conducted with watches, typewriters, vacuum cleaners and electric irons. The trade reactions, magazine excerpts and "aftermaths" given in the books likewise are principally concerned with the automobile.

Heading the trade reactions is a letter from a radio serviceman whose indignation at the accusations ran so high as to render him almost speechless. He said:

"If you would give me the honor of visiting me for about two minutes I'll ask you one question that would stop you before you could open your mouth."

The authors apparently never learned the question.

The authors list the favorable as well as unfavorable reactions and seem to delight in the greater number of latter. Among the magazine excerpts is one from Consumers Union Reports which seem reasonably fair in analyzing both sides of the controversy; but it raises at least one issue which we believe to be of sufficient interest to mention here.

Consumer Reports holds as partially responsible for the situation "that there are too many servicemen for the market to support."

We are not in agreement with this deduction, principally because without statistics on the number of sets in use and the number of servicemen available to repair them, we cannot arrive at such a conclusion. We do know, however, that there are many sets in need of repair whose owners will tolerate it just a little longer. In many cases a change of tubes would revive these sets to a performance equal to new, but set owners continue to boast that they have not had to buy new tubes.

Set owners wait until a tube expires before obtaining a replacement. They would not tolerate a balky automobile that long because the trouble would make itself intolerable through some means, either through cost of fuel or lack of riding comfort. But the radio listener's ear is such a compliant device that it will make minor adjustments after it has been impressed upon that this apparently is what its owner wants. If the serviceman were to suggest that the set owner purchase a new set of tubes, he would undoubtedly be put in the position of trying to sell unnecessary tubes.

The whole subject has already been so thoroughly discussed in letters by *Radio-Craft* readers that we believe it to be a little late for any additional analyses.

**MATHEMATICS FOR ELECTRICIANS AND RADIOMEN**, by Nelson M. Cooke. Published by McGraw-Hill Book Co., Inc., New York, N. Y. Stiff cloth covers, size 9 x 6 ins., 604 pages. Price \$4.00.

There are numerous Experimenters and Servicemen who have gained a large amount of radio knowledge from practical experience but who nevertheless feel humble about radio engineering because they lack the mathematical knowledge frequently required for a thorough understanding of technical articles. These men, thirsting for knowledge, drink in as much of the information as they possibly can, but still feel unsatiated be-

cause they have had to skip over the mathematical expressions or graphs in reading the articles.

Sometimes the alphabetical symbols begin in a simple, readily understandable form but suddenly jump to an apparently more complex form, leaving the reader at a loss to understand how the changes occurred. The processes involved may be extremely simple, requiring only knowledge of factoring, or simple multiplication or division, and were assumed to be understood by the reader.

Frequently the reader vows that he is going to study mathematics and actually opens a book and reads hurriedly through in an attempt to get past the simple stuff and into the deep of it. Soon, however, he is discouraged because he has as yet found nothing bearing any resemblance to the problems he encountered in radio. A, b, c and x, y, z don't seem to answer his purpose. If instead the examples concerned practical application to radio; if I, R, E and C terms with which he is familiar, could be used and the problems were made up of everyday usage terms it would be more realistic to him.

This is exactly what Mathematics for Electricians and Radiomen sets out to do and what it accomplishes. It does it in such an admirable way that the book should enjoy a very wide sale. But no matter how the author and publisher may profit from it, radio will profit more. The author, Chief Radio Electrician Nelson M. Cooke, U. S. Navy, bases this book upon lecture notes compiled over a period of years, and he credits various Navy personnel and former students for "much helpful criticism and suggestions."

The author has done a splendid job. His explanations are clear and concise. Within the first sixty pages a serious student will be using the slide rule—possibly the Cooke Radio Slide rule, specially designed for doing the more common radio and electrical problems. He will also be forming and solving equations—not about how many cows Farmer Jones had left, but about sums and differences of voltage, current and resistance.

The beginner in mathematics may wonder, for instance, about the use of negative numbers. Algebra teachers explain that numbers represent not only quantity but also direction. Various textbooks explain the use of positive and negative numbers by giving illustrations of distances above and below sea level or other similar types of examples. Your reviewer vaguely recalls a mathematics book by Steinmetz which devoted a number of pages to such an explanation by way of horses moving to the left and right of a center scale.

In *Mathematics for Electricians and Radiomen* the author introduces the subject of negative numbers briefly and shows the need for such numbers by drawing two resistances having their junction point connected to ground and their other ends connected across a 6-volt battery. Meters connected across the resistors read a three-volt drop above and below ground potential, while the meter across the battery reads the total of six volts. Such circuits are familiar to Servicemen and Experimenters in radio in full-wave rectifiers (which divide the total voltage in half) and in A.V.C. circuits for supplying negative bias to R.F. amplifier-tube grids.

For a convincing exposition of negative numbers we quote from the book:

"The student must not lose sight of the  
(Continued on following page)

**NOW!**

You can get the math you need for solving everyday radio and electrical problems



Radiomen and electricians know that the language and the habit of mathematics are essential for real progress in their chosen field. They know mathematics is a tool that they are helpless without.

NOW out of the U.S. Navy Radio Materiel School at the Naval Research Laboratory comes a complete home-study book that is so thorough and so detailed that any reader "who can perform arithmetical computations rapidly and accurately is capable of mastering the principles laid down in this text."

**MATHEMATICS for ELECTRICIANS and RADIOMEN**  
By N. M. COOKE, Chief Radio Electrician, U. S. Navy  
604 pages 6 x 9, \$4.00

This book teaches you mathematics from elementary algebra through quadratic equations, logarithms, trigonometry, plane vectors and elementary vector algebra with direct applications to electrical and radio problems. It teaches you how to apply this mathematical knowledge in the solutions of radio and circuit problems. In other words, it gives you the grasp of mathematics you need and then shows you how to use your knowledge.

Based on over 8 years' experience teaching mathematics to U.S. Navy electricians and radio operators, the book gives you 600 illustrative problems worked out in detail and over 3000 practice problems with answers so you can check your work.

**10 DAYS' FREE EXAMINATION**

McGraw-Hill Book Co., 330 W. 42nd St., New York  
Send me Cooke's Mathematics for Electricians and Radiomen for 10 days' examination on approval. In 10 days I will send you \$4.00 plus few cents postage, or return book postpaid. (We pay postage if remittance accompanies order.)

Name \_\_\_\_\_  
Address \_\_\_\_\_  
City and State \_\_\_\_\_  
Position \_\_\_\_\_  
Company \_\_\_\_\_ RC. 7-42

**Headset Headquarters**



Our Headphones are used by the United States, Canadian, New Zealand and South African Governments as well as other Governments not directly in the war. Folder C-7 illustrates rugged, unusually sensitive, dependable Cannon-Ball Headsets. Write...

**C. F. CANNON COMPANY**  
SPRINGWATER, N. Y.

**BIG FREE CATALOG**

**EVERYTHING IN RADIO**

Sets, parts, supplies, public address systems, amateur equipment, testers, kits and fluorescent lighting, at lowest prices. Huge stocks, bought months ago... ready for shipment the same day your order is received. The Defense Program is making big demands on our industry but because of our advance buying we are able to fill your orders promptly and efficiently.



**BURSTEIN-APPLEBEE COMPANY**  
1012-14 McGEE, KANSAS CITY, MO.

**Book Reviews**

(Continued from preceding page)

fact . . . that as far as magnitude, or size, is concerned a negative number may represent a larger absolute value than some positive number. *The positive and negative signs simply denote reference from zero.* For example, if some point in an electric circuit is 1000 volts negative with respect to ground, you may denote it by writing -1000 volts. If you make good contact with your body between that point and ground, your chances of being electrocuted are just as good as if that point was positive 1000 volts with respect to ground—and you wrote it +1000 volts! In this case, *how much* is more important than a matter of sign preceding the number."

Explanations of this sort bring the student much closer to the book than could any number of abstract statements. The author further in the book again makes use of such an explanation in dealing with what in classical mathematics are regarded as *imaginary numbers* but what, in fact, are very real to the radioman or electrician.

The student should not imagine that this book is mathematics made easy. It decidedly is not that. It is mathematics made *understandable*. We venture to say that the equivalent of a three- or four-year high-school course in contained in this volume if considered from the standpoint of the amount of mathematics *useful* to the radioman.

**A RADIO ELECTRO-BALANCE**

(Continued from page 680)

this change. Naturally the change in frequency will be a direct measure of the weight used to alter the capacity.

One very sensitive method of detecting slight changes in frequency, is by the beat, or heterodyne, principle. With this consideration our complete picture would include two separate oscillating circuits, one of these oscillators so arranged that the frequency is altered by the weight of a sample which acts upon the condenser. The other oscillator would be the standard for comparison and should have a means of very carefully changing the capacity to a corresponding change in frequency of the first oscillator. The output of both circuits should be combined through a mixing tube and, with a pair of earphones, or any other type of indicator, we should be able to tell when both circuits are operating at exactly the same frequencies. This provides a direct method of comparison. When the capacities are graduated in terms of grams of weight we would be able to read directly from our condenser the weight of the sample to be tested.

These same principles as stated above can also be made to apply for a change in inductance. Our choice of capacity first was due to the fact that physically we can alter capacity much more easily than we can alter inductance.

Well, we've gone ahead and let our hair down, how about you? Maybe we were thinking along the wrong track, but let's see what will turn up. A lot of criticism we expect, but at least we can hope that reports of experiments prove we are on the right trend. Who knows, someone may even turn up with a working model.

We are convinced that there are a lot of these ideas floating around and we want to hear about them. You give us the dope and we'll help you tear it apart and put it back together again so that maybe something will turn out all right. Anything of a patentable nature will be guided into the proper commercial channels.

An old Chinese saying states that a thought for one is only a thought, but the same thought for two is a problem.

**Complete Plans**

For Building Useful and Practical Things at Home. Each issue of Popular Homecraft is crammed with plans for making such beautiful and useful things as: Furniture, Bird Houses, Lamps, Outdoor Garden Furniture, Candle Equipment, etc. Covers in the work: tools, wood-working, leathercraft, copper. You'll find "how to make almost everything from the pages of Popular Homecraft. Scores of drawings and photographs make every step simple as A B C. A real "How-To-Do-It" magazine.



Six Months' Trial \$1.00

Send \$1.00 today for trial six months' subscription. Money Back If Not Delighted.

**POPULAR HOMECRAFT**

937 Palmolive Building Chicago, Ill.

**Trial 6 Months \$1.00**

**Index to advertisers**

Allied Radio Corp.	663
American Radio Institute	691
Amperite Corp.	633
Arrow Radio Company	676
Audel & Co., Theo.	Back Cover
Audiograph	702
Burstein-Applebee Co.	704
Candler System Co.	691
Cannon Co., C. F.	704
Capitol Radio Engineering Institute	691
Chartered Institute of America	695
Commercial Radio Institute	702
Dodge's Institute	702
Gray (Distributor), N.	700
Hallcrafters, Inc.	Inside Front Cover
Harrison Radio	674
Henry Radio	674
Hudson Specialties Co.	637
Hygrade-Sylvania Corp.	644
Lancaster, Allwine & Rommel	695
Lincoln Engineering School	702
Mass. Radio School	691
Meissner Manufacturing Co.	667
McGraw Hill Book Company	704
National Radio Institute	641
National Union Corp.	652
Ohmite Manufacturing Co.	660
Opportunity Adlets	698
Popular Homecraft	704
Peerless Sound & Radio Co.	688
Radio Corp. of America	646
RCA Institutes	702
RCA Mfg. Co.	Inside Back Cover
Radercraft Publications, Inc.	656, 696
Radelek Co.	651
Schott Co., Walter L.	698
Solar Manufacturing Co.	698
Sprayberry Academy	679
Supreme Instruments Corp.	665
Supreme Publications	702
Technifax	679
Teleplex Co.	698
Treasury Department	643
Tri State College	702
University Labs	698
Wholesale Radio Labs	701
X. L. Radio Labs	698

(While every precaution is taken to insure accuracy, we cannot guarantee against the possibility of an occasional change or omission in the preparation of this index.)

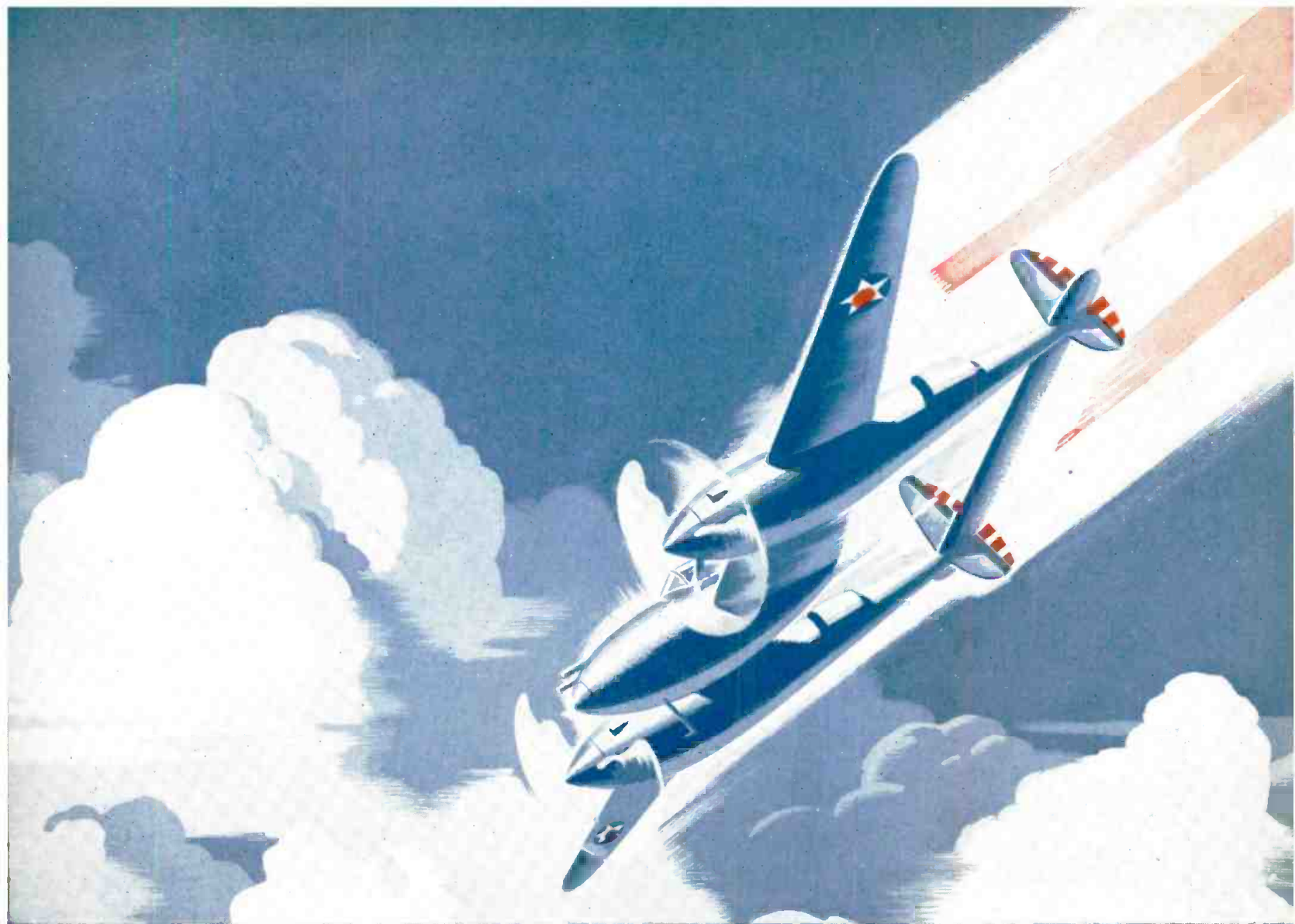

## At 400 miles per hour

You'd Appreciate Metal Tubes!

A POWER DIVE in a pursuit plane is something to write home about! Your engines roar...the wind shrieks and screams...the airspeed indicator climbs past 300, 350, 400, toward terminal velocity. As you ease back on the stick to pull her out, enormous stresses wrench at the vitals of the plane—and at every piece of equipment inside!

Is it any wonder that both the Army and the Navy specify *metal* tubes

for military radio equipment—? Or that RCA is now turning out metal tubes at the fastest pace in our history—? For metal tubes combine extreme ruggedness with positive socket-contact (at the *pins*, where contact *should* be!) along with lower interelectrode-capacitances, greater

compactness, and efficient self-shielding. Only metal tubes can give the *advantages* of metal tubes!

With enormous quantities of RCA Metal Tubes going into equipment for the Democracies, you may experience difficulty or delay in the shipment of *your* orders for non-war purposes. Please be patient. For military equipment *comes first*... and military equipment needs *metal* tubes!



# METAL TUBES

# PRACTICAL RADIO INFORMATION

**Including Frequency Modulation—Television, etc.**

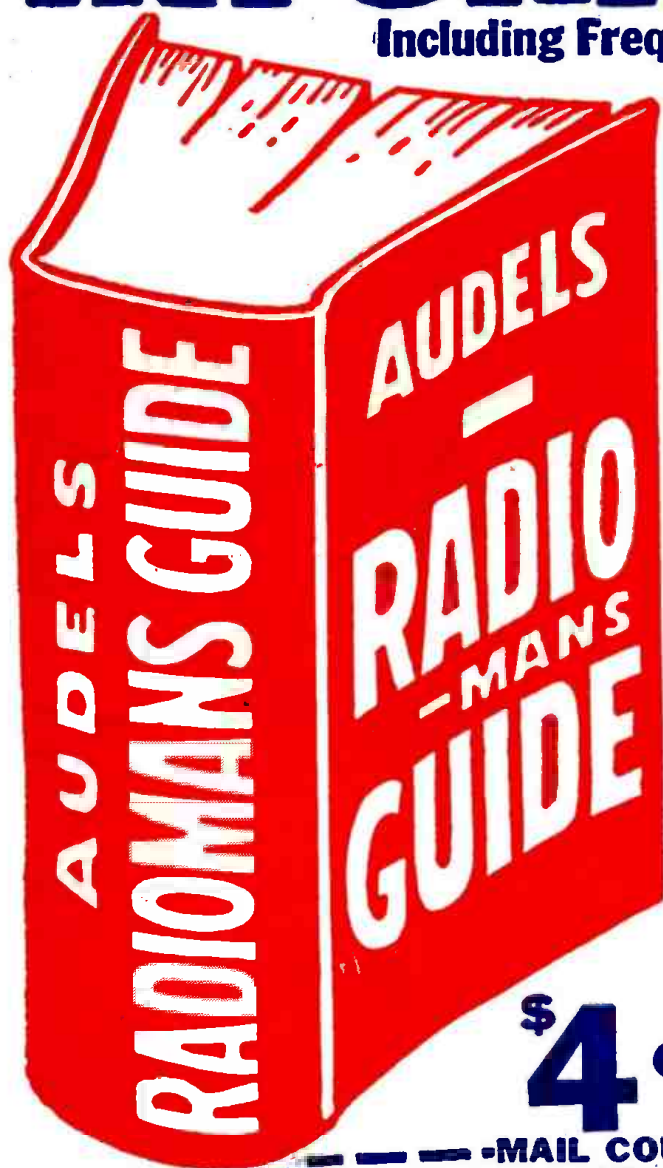

Inside Information for all Servicemen—Aircraft Pilots, Students.

**772 PAGES, 400 DIAGRAMS**

is complete—gives Authentic Principles & Practices in Construction, Operation, Service & Repairs. Covers clearly and concisely Radio fundamentals—Ohm's Law—Physics of sound as related to radio science—Measuring instruments—Power supply—Resistors—Inductors—Condensers—Transformers and examples—Broadcasting stations—Radio Telephony—Receivers—Diagrams—Construction—Control systems—Loud speakers—Antennas—Auto Radio—Phonograph pickups—Public Address Systems—Aircraft & Marine Radio—Radio Compass—Beacons—Automatic Radio Alarms—Short Wave—Coil Calculations—Testing—Cathode ray oscillographs—Static Elimination—Trouble Pointers—Underwriter's standards—Units & tables. REVIEW QUESTIONS—Ready Reference Index.

**\$4**

**COMPLETE • PAY \$1 A MO.**

To get this practical information in handy form—Fill in and

—MAIL COUPON TODAY—

**AUDEL, Publishers; 49 West 23rd St., New York**  
Mail AUDELS NEW RADIOMAN'S GUIDE for free examination. If O. K. I will send you \$1 in 7 days; then remit \$1 monthly until \$4 is paid. Otherwise I will return it.

Name \_\_\_\_\_

Address \_\_\_\_\_

Occupation \_\_\_\_\_

Reference \_\_\_\_\_

RCF